



# MICROSCOPY CATALOGUE

# OPTIKA Milestones





































- 
- The background of the slide is a photograph of an OPTIKA exhibition stand. The stand features large, illuminated letters spelling 'OPTIKA' and 'ITALY'. There are several microscopes on display on the stand, and the overall lighting is bright and professional.
- 1996** First **LED brightfield** microscope in the world
  - 2002** First **2-in-1 gemological** microscope in the world
  - 2002** First **LED darkfield** illuminator for stereomicroscopes in the world
  - 2003** First **LED fluorescence** microscope in the world
  - 2004** **Infinifix** (infinity optical system with 160mm objectives)
  - 2005** First **LED metallurgical** microscope
  - 2006** **X-LED** illumination system - the original
  - 2007** First **LED darkfield** illuminator **for blood analysis** in the world
  - 2008** First **Windows tablet PC with integrated microscope camera** in the world
  - 2009** First full **Automatic Light Control (ALC)** in the world
  - 2010** Full **motorized microscope controlled by mouse** in the world
  - 2011** Full **motorized microscope controlled by touch-screen monitor** in the world
  - 2013** First **digital microscope with integrated Windows tablet PC** in the world
  - 2015** First **rechargeable microscope with Li-Ion battery** in the world
  - 2017** First **educational microscope with oil/water 100x** objective in the world

# INDEX

- ① EDUCATIONAL Microscopes** page 5
- ② LABORATORY Microscopes** page 85
- ③ INSPECTION & INDUSTRIAL Microscopes** page 259
- ④ CAMERAS & DIGITAL Solutions** page 371
- ⑤ POLARIMETRY AND REFRACTOMETRY** page 407



# Complete Icon List

 Field number	 U-Plan objectives (up to 24mm f.o.v)	 Tablet screen size
 Incident light	 Oil/Water 100x objective	 Camera resolution
 Transmitted light	 Fluorescence	 CCD sensor
 LED illuminator	 Metallography	 CMOS sensor
 X-LED illuminator	 Polarized light	 Software included
 Automatic light control	 Darkfield	 HDMI output
 Multi-Plug low voltage power supply	 Phase contrast	 SD/MicroSD slot
 Rechargeable battery	 Differential interference contrast	 Wi-Fi
 Li-Ion rechargeable battery	 Fixed objective	 BlueTooth
 IOS infinity corrected optics	 Zoom objective	 Cooling system
 High contrast objectives	 USB 2.0 input (mouse)	 Mouse included
 N-Plan objectives (up to 20mm f.o.v)	 USB 2.0 output	
 W-Plan objectives (up to 22mm f.o.v)	 USB 3.0 output	



***EDUCATIONAL Microscopes***

# EDUCATIONAL Microscopes























## *Biological Microscopes*

<b>ECOVISION SERIES</b> - Entry-Level Biological Microscopes For Students	page 7
<b>B-60 SERIES</b> - Entry-Level Biological Microscopes For Students	page 17
<b>B-150 SERIES</b> - Middle-Level Biological Microscopes For Students	page 25
<b>B-190 SERIES</b> - Advanced Biological Microscopes For Students And Teachers	page 47

## *Stereomicroscopes*

<b>MS/SFX SERIES</b> - Entry-Level Monoscopes & Stereomicroscopes For Students	page 63
<b>SLX SERIES</b> - Stereomicroscopes For Students And Teachers	page 77

## Icons

	Field number		Li-Ion Rechargeable battery		Tablet screen size
	Incident light		High contrast objectives		Camera resolution
	Transmitted light		N-Plan objectives (up to 20mm f.o.v)		Software included
	LED illuminator		Oil/Water 100x objective		HDMI output
	X-LED illuminator		Polarized light		MicroSD slot
	Automatic light control		Fixed objective		Wi-Fi
	Multi-plug low voltage power supply		Zoom objective		BlueTooth
	Rechargeable battery		USB connection		

# ECOVISION Series



**Entry-Level Biological Microscopes For Students**

# A Range Of Quality Microscopes For Beginners

## DESIGNED FOR NOVICE USERS

- » Reliable microscopes for education
- » Particularly recommended for primary school
- » Get great images and live videos with eyepiece cameras

## BIOLOGICAL EDUCATIONAL MICROSCOPES

- » Choose among monocular and binocular heads
- » 18mm field number for a good observation area
- » Achromatic lenses for common applications





# Attention To Detail

## HANDY, YET EXTREMELY STABLE

- » Compact, practical and intuitive to use
- » Achromatic optics ensuring good quality images
- » Easy to handle, also by the youngest students

## EASY TO TAKE CARE OF

- » Sturdy and durable for extended lifetime
- » No maintenance required
- » Dust cover (included) protects from environmental contaminants



## ECOVISION Series

OPTIKA ECOVISION Series includes monocular and binocular biological microscopes, designed especially for students attending primary school. Slim and easy to carry solutions, they are equipped with all the basic controls of an optical microscope and all you need to start learning to use a scientific instrument: 18 mm field of view, up to 400x maximum magnification (1000x as optional), several options concerning stages, focusing, condenser and illumination system.

### Easy To Carry Solutions

This series is characterized by extreme compactness and portability as models can be moved easily in the classroom or even outdoors.

The body of the microscope is slim and, according to the model, provided with a useful handle: the teaching activity will be facilitated and more enjoyable.

### Extremely Easy And Fast Vision

You find here the basic controls of an optical microscope and all you need to start learning to use a scientific instrument. Pre-aligned illumination and condenser simplify the operation and make necessary just the focusing of the specimen by using the dedicated knobs.

### LED - Optimized Illumination

Money & energy saving thanks to LED long lifetime (65.000 hours, 22 years in case of 8 hours/day) which is more than 20 times compared to a standard halogen bulb.



# Entry-Level Biological Microscopes For Students

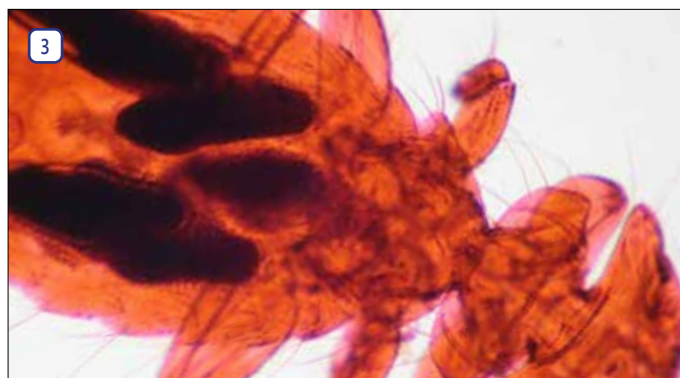
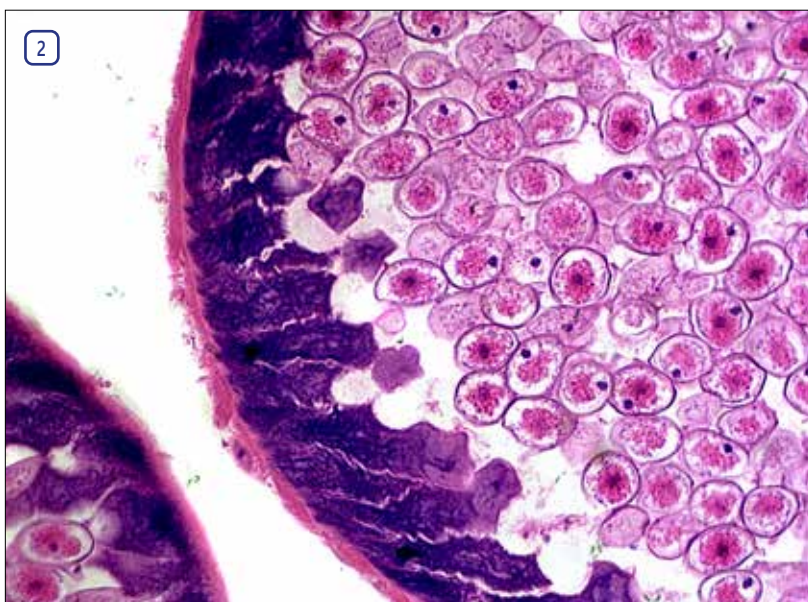

## Legend

1. Mechanical stage of B-20CR.
2. Ascaris female, 10x objective.
3. Dust mite, with B-20R and 40x objective.
4. Ergonomical coaxial coarse and fine focusing mechanism of B-20CR.

## B-20R



Cordless simple microscope equipped with efficient LED illumination with rechargeable batteries. Comfortable handle makes this model ideal for the youngest students.

**Observation mode:** Brightfield.

**Head:** Monocular, 45° inclined; 360° rotating.

**Eyepiece:** WF10x/18 mm.

**Nosepiece:** Triple ball bearings revolving nosepiece.

**Objectives:**

- Achromatic 4x/0.10, with anti-fungus treatment
- Achromatic 10x/0.25, with anti-fungus treatment
- Achromatic 40x/0.65, with anti-fungus treatment

**Specimen stage:** X-Y moving and 360° rotating, 90 mm diameter, with sample clips.

**Focusing:** Separate coarse and fine focusing mechanism with limit stop to prevent the contact between objective and specimen.

**Condenser:** Diffusing filter with rotating diaphragm wheel.

**Illumination:** 0.3 W LED, with light intensity control, rechargeable batteries. Color temperature: 6,300 K. 100-240Vac/5Vdc external power supply.

## B-20CR



Same as B-20R but complete of mechanical stage, condenser and coaxial focusing knobs.

**Observation mode:** Brightfield.

**Head:** Monocular, 45° inclined; 360° rotating.

**Eyepiece:** WF10x/18 mm, secured by screw.

**Nosepiece:** Triple ball bearings revolving nosepiece.

**Objectives:**

- Achromatic 4x/0.10, with anti-fungus treatment
- Achromatic 10x/0.25, with anti-fungus treatment
- Achromatic 40x/0.65, with anti-fungus treatment

**Specimen stage:** Double layer, 105x95 mm, moving range 50x15 mm.

**Focusing:** Coaxial coarse and fine focusing mechanism with limit stop to prevent the contact between objective and specimen.

**Condenser:** N.A. 0.65 with iris diaphragm.

**Illumination:** 0.5 W LED, with light intensity control, rechargeable batteries. Color temperature: 6,300 K. 100-240Vac/5Vdc external power supply.

# ECOVISION Series - M-100 Models

1

Educational

## M-100FX

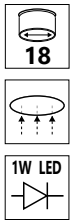

Classic monocular microscope equipped with ultra-efficient LED illumination, 45° inclined and 360° rotating head.

**Observation mode:** Brightfield.

**Head:** Monocular, 45° inclined; 360° rotating.

**Eyepiece:** WF10x/18 mm, secured by screw.

**Nosepiece:** Triple ball bearings revolving nosepiece.

**Objectives:**

- Achromatic 4x/0.10, with anti-fungus treatment
- Achromatic 10x/0.25, with anti-fungus treatment
- Achromatic 40x/0.65, with anti-fungus treatment

**Specimen stage:** Fixed stage, 120x110 mm. With sample clips.

**Focusing:** Separate coarse and fine focusing mechanism with limit stop to prevent the contact between objective and specimen.

**Condenser:** N.A. 0.65 with iris diaphragm.

**Illumination:** 1 W LED. Color temperature: 6,300 K. 100-240Vac/12Vdc external power supply.

**Models available:**

- M-100FX-EU** Monocular brightfield microscope, EU
- M-100FX-UK** Monocular brightfield microscope, UK adapter
- M-100FX-US** Monocular brightfield microscope, US adapter

## M-100FLed

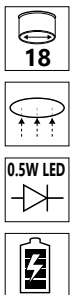

Classic monocular microscope equipped with efficient LED illumination and internal rechargeable batteries which provides up to 8 hours of outdoor use.

**Observation mode:** Brightfield.

**Head:** Monocular, 45° inclined; 360° rotating.

**Eyepiece:** WF10x/18 mm, secured by screw.

**Nosepiece:** Triple ball bearings revolving nosepiece.

**Objectives:**

- Achromatic 4x/0.10, with anti-fungus treatment
- Achromatic 10x/0.25, with anti-fungus treatment
- Achromatic 40x/0.65, with anti-fungus treatment

**Specimen stage:** Fixed stage, 120x110 mm. With sample clips.

**Focusing:** Separate coarse and fine focusing mechanism with limit stop to prevent the contact between objective and specimen.

**Condenser:** N.A. 0.65 with iris diaphragm.

**Illumination:** 0.5 W LED, with light intensity control, rechargeable batteries. Color temperature: 6,300 K. 100-240Vac/12Vdc external power supply.

**Models available:**

- M-100FLed-EU** Monocular brightfield microscope, EU
- M-100FLed-UK** Monocular brightfield microscope, UK adapter

# ECOVISION Series - Comparison chart

Model	Head	Eyepieces	Nosepiece	Objectives	Stage	Focusing	Condenser	Illumination
<b>B-20R</b>	Monocular, 45° inclined, 360° rotating	WF 10x/18	Triple, reversed	Achromatic 4x, 10x, 40x	X-Y moving, 360° rotating, 90 mm diameter, with sample clips	Separate coarse and fine	Diffusing filter with rotating diaphragm wheel	0.3 W LED, with brightness control, rechargeable batteries
<b>B-20CR</b>	Monocular, 45° inclined, 360° rotating	WF 10x/18	Triple, reversed	Achromatic 4x, 10x, 40x	Double layer, 105x95 mm, moving range 50x15 mm	Coaxial coarse and fine	N.A. 0.65, with iris diaphragm	0.5 W LED, with brightness control, rechargeable batteries
<b>M-100FX</b>	Monocular, 45° inclined, 360° rotating	WF 10x/18	Triple	Achromatic 4x, 10x, 40x	Fixed, 120x110 mm, with sample clips	Separate coarse and fine	N.A. 0.65, with iris diaphragm	1 W LED
<b>M-100Fled</b>	Monocular, 45° inclined, 360° rotating	WF 10x/18	Triple	Achromatic 4x, 10x, 40x	Fixed, 120x110 mm, with sample clips	Separate coarse and fine	N.A. 0.65, with iris diaphragm	0.5 W LED, with brightness control, rechargeable batteries

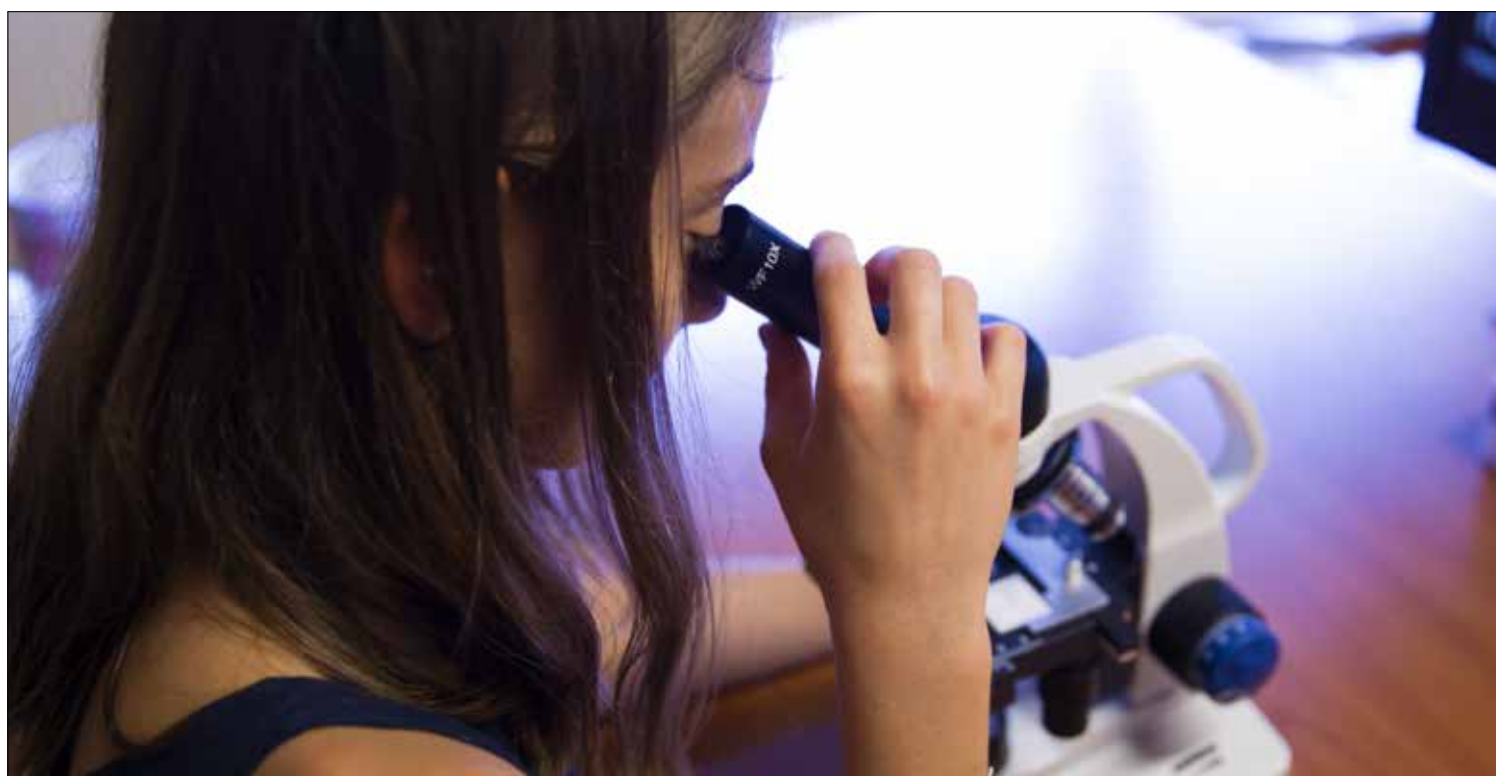

## ECOVISION Series - Zoom comparison

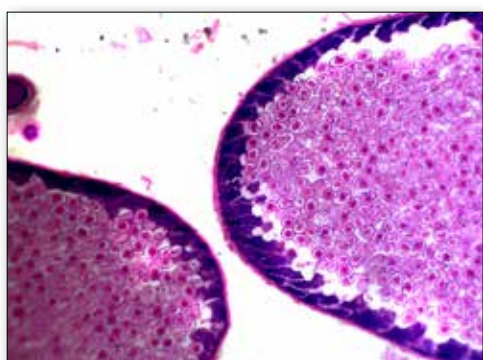

Ascaris female - 4x objective

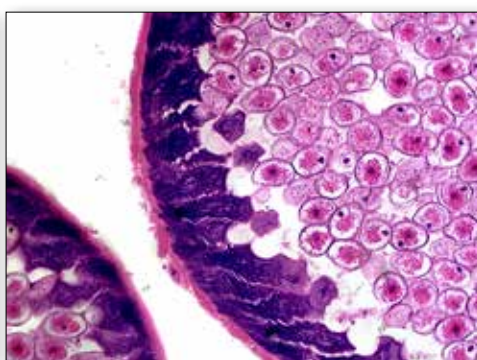

Ascaris female - 10x objective

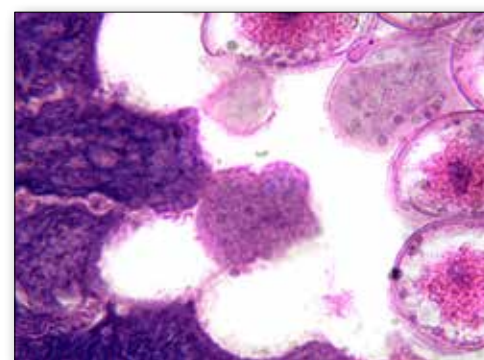

Ascaris female - 40x objective

# ECOVISION Series - Accessories

1

Educational

## ACCESSORIES FOR B-20R / B-20CR

### Eyecups & Eyepieces

M-002.2	WF10x/18 eyepiece
M-003.2	WF15x/12 eyepiece
M-004.2	WF10x/18 micrometric eyepiece
M-008.2	WF10x/18 eyepiece, with pointer
M-162	WF20x/10 eyepiece

### Objectives & Additional Lenses

M-115	0.35x C-Mount projection lens
M-114	0.5x C-Mount projection lens
M-118	0.75x C-Mount projection lens

### Miscellaneous

15104	Cleaning kit
M-005	Micrometric slide, 26x76mm, with 2 scales (1mm/100 & 10mm/100)
M-069	Solar charger
DC-001	Plastic dust cover, small, 340(l)x400(h) mm

### M-069 - Solar charger

Included battery: rechargeable – Lithium-Poly. Capacity: 2600 mAh.  
Output voltage: 5.5Vdc. - Dimensions: 120x73x10 mm.  
Autonomy: over 6 hours at medium intensity (X-LED<sup>3</sup>).  
Charging modes: with solar panel (12h),  
with external USB power supply  
(not included) or from PC USB port (5h).



## ACCESSORIES FOR M-100FX / M-100FLed

### Eyecups & Eyepieces

M-001	Huygens 5x eyepiece
M-002.2	WF10x/18 eyepiece
M-004.2	WF10x/18 micrometric eyepiece
M-008.2	WF10x/18 eyepiece, with pointer
M-003.2	WF15x/12 eyepiece
M-162	WF20x/10 eyepiece

### Objectives & Additional Lenses

M-131	Achromatic objective 4x/0.10
M-132	Achromatic objective 10x/0.25
M-133	Achromatic objective 20x/0.40
M-134	Achromatic objective 40x/0.65
M-135	Achromatic objective 60x/0.85
M-136	Achromatic objective 100x/1.25 (oil)

### Camera Adapters

M-115	0.35x C-Mount projection lens
M-114	0.5x C-Mount projection lens
M-118	0.75x C-Mount projection lens

### Stages

M-040	Attachable mechanical stage
-------	-----------------------------

### Condensers & Filters

M-099	Polarising set (filters and rotating stage)
-------	---

### Miscellaneous

15008	Immersion oil, 10ml
15009	Immersion oil, 100ml
15104	Cleaning kit
DC-001	Plastic dust cover, small, 340(l)x400(h) mm
M-005	Micrometric slide, 26x76mm, with 2 scales (1mm/100 & 10mm/100)
M-069	Solar charger

### 15104 - Cleaning kit

It cleans glass quickly and effectively,  
without leaving residue or odor.  
Ideal for precision lens or prism cleaning.



### How to connect the cameras to our microscopes.

Please refer to the Adapter reference list on Digital section.



v 1.4.0 - OPTIKA reserves the right to make corrections, modifications, enhancements, improvements and other changes to its products at any time without notice.

---

## Headquarters and Manufacturing Facilities

---

**OPTIKA® S.r.l.** Via Rigla, 30 - 24010 Ponteranica (BG) - ITALY - Tel.: +39 035.571.392 - [info@optikamicroscopes.com](mailto:info@optikamicroscopes.com)

### Optika Sales branches

---

**OPTIKA® Spain** [spain@optikamicroscopes.com](mailto:spain@optikamicroscopes.com)  
**OPTIKA® China** [china@optikamicroscopes.com](mailto:china@optikamicroscopes.com)  
**OPTIKA® India** [india@optikamicroscopes.com](mailto:india@optikamicroscopes.com)

**OPTIKA® USA** [usa@optikamicroscopes.com](mailto:usa@optikamicroscopes.com)  
**OPTIKA® Central America** [camerica@optikamicroscopes.com](mailto:camerica@optikamicroscopes.com)



## B-60 Series



**Entry-Level Biological Microscopes For Students**



# Cordless Educational Microscopes, Ideal To Start Exploring

## PERFECT FOR STUDENT'S FIRST EXPERIENCES

- » Designed for novice users (students and primary schools especially)
- » Easy to handle, also by the youngest users
- » Longlife LED illumination (providing over 20 years of use)
- » Compact, practical and intuitive to use
- » Sturdy and durable for extended lifetime

## COMFORTABLE, INTUITIVE & RELIABLE SOLUTIONS

- » 18 mm field number for an extended observation area
- » StagErase™ eraseable stage to reduce scratches
- » Arm/wrist rest support to reduce the fatigue during use
- » Cordless use, totally independent from the mains connection
- » External power supply for enhanced safety and convenient servicing





## B-60 Series

A wide range of cordless, modern microscopes ideal for students and mainly primary schools with achromatic lenses, FN 18, finite optical system, coaxial focusing, StagErase™ erasable mechanical stage and 1 W LED illumination with rechargeable batteries. Slim and easy to carry, all the models are equipped with arm/wrist rest support to reduce the fatigue during use and long lasting LED illumination to provide over 20 years of use.



### Arm/wrist rest support to reduce the fatigue during use

Students get relaxed and stay relaxed when using the microscope! Effective in preventing fatigue during operation, increasing the ergonomics and the performance as a result.

### StagErase™ erasable stage to remove scratches

Here's something you've never seen before! This new, revolutionary stage is coated with a special painting to reduce accidental scratches to the minimum and facilitate their removal.



### Cordless use, totally independent from the mains connection

All models work with or without the batteries in place and are provided with three NiMH rechargeable batteries for outdoor use (4-hour autonomy, at medium intensity).

### Low voltage, external power supply for enhanced safety and convenient servicing

OPTIKA's safety first approach drives to the use of a multi-plug, external power supply in order to prevent any risk of electric shock and heatflow inside the unit.

### Longlife LED illumination (providing over 20 years of use)

Money & energy saving thanks to LED long lifetime (65.000 hours, 22 years in case of 8 hours/day) which is more than 20 times compared to a standard halogen bulb.



# B-60 Series - Models

## B-61



Cordless, modern monocular microscope ideal for students and mainly primary schools with achromatic lenses (400x), FN 18, finite optical system, coaxial focusing, StagErase™ erasable fixed stage and 1 W LED illumination with rechargeable batteries. Slim and easy to carry, it is equipped with arm /wrist rest support to reduce the fatigue during use and long lasting LED illumination to provide over 20 years of use.

**Observation mode:** Brightfield.

**Head:** Monocular, 45° inclined; 360° rotating.

**Eyepiece:** WF10x/18 mm, secured by screw.

**Nosepiece:** Quadruple ball bearings revolving nosepiece, reversed.

**Objectives:**

- Achromatic 4x/0.10, with anti-fungus treatment
- Achromatic 10x/0.25, with anti-fungus treatment
- Achromatic 40x/0.65, with anti-fungus treatment

**Specimen stage:** StagErase™ erasable fixed stage, 120x110 mm, with sample clips.

**Focusing:** Coaxial coarse and fine focusing mechanism with limit stop to prevent the contact between objective and specimen.

**Condenser:** N.A. 0.65 with iris diaphragm.

**Illumination:** 1 W LED, with brightness control, rechargeable batteries. Color temperature: 6,300 K. Multi-plug 100-240Vac/5Vdc external power supply.

## B-62



Cordless, modern monocular microscope ideal for students and mainly primary schools with achromatic lenses (400x), FN 18, finite optical system, coaxial focusing, StagErase™ erasable mechanical stage, Abbe condenser and 1 W LED illumination with rechargeable batteries. Slim and easy to carry, it is equipped with arm/wrist rest support to reduce the fatigue during use and long lasting LED illumination to provide over 20 years of use.

**Observation mode:** Brightfield.

**Head:** Monocular, 45° inclined; 360° rotating.

**Eyepiece:** WF10x/18 mm, secured by screw.

**Nosepiece:** Quadruple ball bearings revolving nosepiece, reversed.

**Objectives:**

- Achromatic 4x/0.10, with anti-fungus treatment
- Achromatic 10x/0.25, with anti-fungus treatment
- Achromatic 40x/0.65, with anti-fungus treatment

**Specimen stage:** StagErase™ erasable mechanical stage, 125x125 mm, 62x24 mm X-Y movement range. Vernier scale on the two axes, accuracy: 0.1 mm.

**Focusing:** Coaxial coarse and fine focusing mechanism with limit stop to prevent the contact between objective and specimen.

**Condenser:** Abbe N.A. 1.25, pre-centered, focusable, with iris diaphragm.

**Illumination:** 1 W LED, with brightness control, rechargeable batteries. Color temperature: 6,300 K. Multi-plug 100-240Vac/5Vdc external power supply.

## B-63



Cordless, modern monocular microscope ideal for students and mainly primary schools with achromatic lenses (600x), FN 18, finite optical system, coaxial focusing, StagErase™ erasable mechanical stage, Abbe condenser and 1 W LED illumination with rechargeable batteries. Slim and easy to carry, it is equipped with arm/wrist rest support to reduce the fatigue during use and long lasting LED illumination to provide over 20 years of use.

**Observation mode:** Brightfield.

**Head:** Monocular, 45° inclined; 360° rotating.

**Eyepiece:** WF10x/18 mm, secured by screw.

**Nosepiece:** Quadruple ball bearings revolving nosepiece, reversed.

**Objectives:**

- Achromatic 4x/0.10, with anti-fungus treatment
- Achromatic 10x/0.25, with anti-fungus treatment
- Achromatic 40x/0.65, with anti-fungus treatment
- Achromatic 60x/0.85, with anti-fungus treatment

**Specimen stage:** StagErase™ erasable mechanical stage, 125x125 mm, 62x24 mm X-Y movement range.

Vernier scale on the two axes, accuracy: 0.1 mm.

**Focusing:** Coaxial coarse and fine focusing mechanism with limit stop to prevent the contact between objective and specimen.

**Condenser:** Abbe N.A. 1.25, pre-centered, focusable, with iris diaphragm.

**Illumination:** 1 W LED, with brightness control, rechargeable batteries. Color temperature: 6,300 K. Multi-plug 100-240Vac/5Vdc external power supply.

## B-65



Cordless, modern monocular microscope ideal for students and mainly primary schools with achromatic lenses (1000x), FN 18, finite optical system, coaxial focusing, StagErase™ erasable mechanical stage, Abbe condenser and 1 W LED illumination with rechargeable batteries. Slim and easy to carry, it is equipped with arm/wrist rest support to reduce the fatigue during use and long lasting LED illumination to provide over 20 years of use.

**Observation mode:** Brightfield.

**Head:** Monocular, 45° inclined; 360° rotating.

**Eyepiece:** WF10x/18 mm, secured by screw.

**Nosepiece:** Quadruple ball bearings revolving nosepiece, reversed.

**Objectives:**

- Achromatic 4x/0.10, with anti-fungus treatment
- Achromatic 10x/0.25, with anti-fungus treatment
- Achromatic 40x/0.65, with anti-fungus treatment
- Achromatic 100x/1.25 (oil), with anti-fungus treatment

**Specimen stage:** StagErase™ erasable mechanical stage, 125x125 mm, 62x24 mm X-Y movement range.

Vernier scale on the two axes, accuracy: 0.1 mm.

**Focusing:** Coaxial coarse and fine focusing mechanism with limit stop to prevent the contact between objective and specimen.

**Condenser:** Abbe N.A. 1.25, pre-centered, focusable, with iris diaphragm.

**Illumination:** 1 W LED, with brightness control, rechargeable batteries. Color temperature: 6,300 K. Multi-plug 100-240Vac/5Vdc external power supply.

**B-66**

Cordless, modern binocular microscope ideal for students and mainly primary schools with achromatic lenses (400x), FN 18, finite optical system, coaxial focusing, StagErase™ erasable mechanical stage, Abbe condenser and 1 W LED illumination with rechargeable batteries. Slim and easy to carry, it is equipped with arm/wrist rest support to reduce the fatigue during use and long lasting LED illumination to provide over 20 years of use.

**Observation mode:** Brightfield.

**Head:** Binocular, 30° inclined; 360° rotating.

Dioptric adjustment: Left eyepiece.

**Eyepiece:** WF10x/18 mm, secured by screw

**Nosepiece:** Quadruple ball bearings revolving nosepiece, reversed.

**Objectives:**

- Achromatic 4x/0.10, with anti-fungus treatment
- Achromatic 10x/0.25, with anti-fungus treatment
- Achromatic 40x/0.65, with anti-fungus treatment

**Specimen stage:** StagErase™ erasable mechanical stage, 125x125 mm, 62x24 mm X-Y movement range. Vernier scale on the two axes, accuracy: 0.1 mm.

**Focusing:** Coaxial coarse and fine focusing mechanism with limit stop to prevent the contact between objective and specimen.

**Condenser:** Abbe N.A. 1.25, pre-centered, focusable, with iris diaphragm.

**Illumination:** 1 W LED, with brightness control, rechargeable batteries. Color temperature: 6,300 K. Multi-plug 100-240Vac/5Vdc external power supply.

**B-67**

Cordless, modern binocular microscope ideal for students and mainly primary schools with achromatic lenses (600x), FN 18, finite optical system, coaxial focusing, StagErase™ erasable mechanical stage, Abbe condenser and 1 W LED illumination with rechargeable batteries. Slim and easy to carry, it is equipped with arm/wrist rest support to reduce the fatigue during use and long lasting LED illumination to provide over 20 years of use.

**Observation mode:** Brightfield.

**Head:** Binocular, 30° inclined; 360° rotating.

Dioptric adjustment: Left eyepiece.

**Eyepiece:** WF10x/18 mm, secured by screw

**Nosepiece:** Quadruple ball bearings revolving nosepiece, reversed.

**Objectives:**

- Achromatic 4x/0.10, with anti-fungus treatment
- Achromatic 10x/0.25, with anti-fungus treatment
- Achromatic 40x/0.65, with anti-fungus treatment
- Achromatic 60x/0.85, with anti-fungus treatment

**Specimen stage:** StagErase™ erasable mechanical stage, 125x125 mm, 62x24 mm X-Y movement range. Vernier scale on the two axes, accuracy: 0.1 mm.

**Focusing:** Coaxial coarse and fine focusing mechanism with limit stop to prevent the contact between objective and specimen.

**Condenser:** Abbe N.A. 1.25, pre-centered, focusable, with iris diaphragm.

**Illumination:** 1 W LED, with brightness control, rechargeable batteries. Color temperature: 6,300 K. Multi-plug 100-240Vac/5Vdc external power supply.

# B-60 Series - Models

## B-69

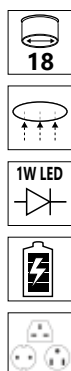

Cordless, modern binocular microscope ideal for students and mainly primary schools with achromatic lenses (1000x), FN 18, finite optical system, coaxial focusing, StagErase™ erasable mechanical stage, Abbe condenser and 1 W LED illumination with rechargeable batteries. Slim and easy to carry, it is equipped with arm/wrist rest support to reduce the fatigue during use and long lasting LED illumination to provide over 20 years of use.

**Observation mode:** Brightfield.

**Head:** Binocular, 30° inclined; 360° rotating.

Dioptic adjustment: Left eyepiece.

**Eyepiece:** WF10x/18 mm, secured by screw

**Nosepiece:** Quadruple ball bearings revolving nosepiece, reversed.

**Objectives:**

- Achromatic 4x/0.10, with anti-fungus treatment
- Achromatic 10x/0.25, with anti-fungus treatment
- Achromatic 40x/0.65, with anti-fungus treatment
- Achromatic 100x/1.25 (oil), with anti-fungus treatment

**Specimen stage:** StagErase™ erasable mechanical stage, 125x125 mm, 62x24 mm X-Y movement range. Vernier scale on the two axes, accuracy: 0.1 mm.

**Focusing:** Coaxial coarse and fine focusing mechanism with limit stop to prevent the contact between objective and specimen.

**Condenser:** Abbe N.A. 1.25, pre-centered, focusable, with iris diaphragm.

**Illumination:** 1 W LED, with brightness control, rechargeable batteries. Color temperature: 6,300 K. Multi-plug 100-240Vac/5Vdc external power supply.

## B-60 Series - Comparison chart

Model	Head	Eyepiece(s)	Nosepiece	Objectives	Stage	Focusing	Condenser	Illuminator
<b>B-61</b>	Monocular, 360° rotating, 45° inclined	Wide Field 10x/18mm	Quadruple, reversed	Achromatic 4x, 10x, 40x	Fixed, 120x110 mm	Coaxial coarse and fine focusing	N.A. 0.65 with iris diaphragm	1 W LED, brightness control, rechargeable batteries
<b>B-62</b>	Monocular, 360° rotating, 45° inclined	Wide Field 10x/18mm	Quadruple, reversed	Achromatic 4x, 10x, 40x	Mechanical, 125x125 mm with 62x24 mm X-Y moving range	Coaxial coarse and fine focusing	N.A. 1.25 Abbe type with iris diaphragm	1 W LED, brightness control, rechargeable batteries
<b>B-63</b>	Monocular, 360° rotating, 45° inclined	Wide Field 10x/18mm	Quadruple, reversed	Achromatic 4x, 10x, 40x, 60x	Mechanical, 125x125 mm with 62x24 mm X-Y moving range	Coaxial coarse and fine focusing	N.A. 1.25 Abbe type with iris diaphragm	1 W LED, brightness control, rechargeable batteries
<b>B-65</b>	Monocular, 360° rotating, 45° inclined	Wide Field 10x/18mm	Quadruple, reversed	Achromatic 4x, 10x, 40x, 100x (oil)	Mechanical, 125x125 mm with 62x24 mm X-Y moving range	Coaxial coarse and fine focusing	N.A. 1.25 Abbe type with iris diaphragm	1 W LED, brightness control, rechargeable batteries
<b>B-66</b>	Binocular, 360° rotating, 30° inclined	Wide Field 10x/18mm	Quadruple, reversed	Achromatic 4x, 10x, 40x	Mechanical, 125x125 mm with 62x24 mm X-Y moving range	Coaxial coarse and fine focusing	N.A. 1.25 Abbe type with iris diaphragm	1 W LED, brightness control, rechargeable batteries
<b>B-67</b>	Binocular, 360° rotating, 30° inclined	Wide Field 10x/18mm	Quadruple, reversed	Achromatic 4x, 10x, 40x, 60x	Mechanical, 125x125 mm with 62x24 mm X-Y moving range	Coaxial coarse and fine focusing	N.A. 1.25 Abbe type with iris diaphragm	1 W LED, brightness control, rechargeable batteries
<b>B-69</b>	Binocular, 360° rotating, 30° inclined	Wide Field 10x/18mm	Quadruple, reversed	Achromatic 4x, 10x, 40x, 100x (oil)	Mechanical, 125x125 mm with 62x24 mm X-Y moving range	Coaxial coarse and fine focusing	N.A. 1.25 Abbe type with iris diaphragm	1 W LED, brightness control, rechargeable batteries

# B-60 Series - Accessories

## Eyecups & Eyepieces

M-001	Huygens 5x eyepiece
M-002.2	WF10x/18 eyepiece
M-004.2	WF10x/18 micrometric eyepiece
M-008.2	WF10x/18 eyepiece, with pointer
M-003.2	WF15x/12 eyepiece
M-162	WF20x/10 eyepiece

## Objectives & Additional Lenses

M-131	Achromatic objective 4x/0.10
M-132	Achromatic objective 10x/0.25
M-133	Achromatic objective 20x/0.40
M-134	Achromatic objective 40x/0.65
M-135	Achromatic objective 60x/0.85
M-136	Achromatic objective 100x/1.25 (oil)

## Stages

M-040	Attachable mechanical stage (only for B-61)
-------	---

## Condensers & Filters

M-155.2	Polarising set (filters only)
---------	-------------------------------

## Camera Adapters

M-115	0.35x C-Mount projection lens
M-114	0.5x C-Mount projection lens
M-118	0.75x C-Mount projection lens

## Miscellaneous

15008	Immersion oil, 10ml
15009	Immersion oil, 100ml
15104	Cleaning kit
DC-001	Plastic dust cover, small, 340(l)x400(h) mm
M-005	Micrometric slide, 26x76mm, with 2 scales (1mm/100 & 10mm/100)
M-069	Solar charger
M-970	Plane-concave mirror, with base (only for B-61)

## 15104 - Cleaning kit

It cleans glass quickly and effectively, without leaving residue or odor. Ideal for precision lens or prism cleaning.



## M-069 - Solar charger

Included battery: rechargeable – Lithium-Poly. Capacity: 2600 mAh. Output voltage: 5.5Vdc. - Dimensions: 120x73x10 mm. Autonomy: over 6 hours at medium intensity (X-LED<sup>3</sup>). Charging modes: with solar panel (12h), with external USB power supply (not included) or from PC USB port (5h).



### How to connect the cameras to our microscopes.

Please refer to the Adapter reference list on Digital section.

v 1.4.0 - OPTIKA reserves the right to make corrections, modifications, enhancements, improvements and other changes to its products at any time without notice.

## Headquarters and Manufacturing Facilities

**OPTIKA® S.r.l.** Via Rigla, 30 - 24010 Ponteranica (BG) - ITALY - Tel.: +39 035.571.392 - info@optikamicroscopes.com

## Optika Sales branches

**OPTIKA® Spain** spain@optikamicroscopes.com  
**OPTIKA® China** china@optikamicroscopes.com  
**OPTIKA® India** india@optikamicroscopes.com

**OPTIKA® USA** usa@optikamicroscopes.com  
**OPTIKA® Central America** america@optikamicroscopes.com



## B-150 Series



**Middle-Level Biological Microscopes For Students**

# 100x With Water – A New Frontier In Education

## SAME OBJECTIVE FOR OIL AND WATER USE

- » Oil represents the best media for high numerical apertures
- » Water combines relevant results with convenience
- » Water is recommended especially for educational purposes

## UNPARALLELED TIME & MONEY SAVINGS

- » Save time by forgetting about tedious cleaning
- » No time-wasting procedures
- » No additional expenses due to inappropriate cleaning & maintenance

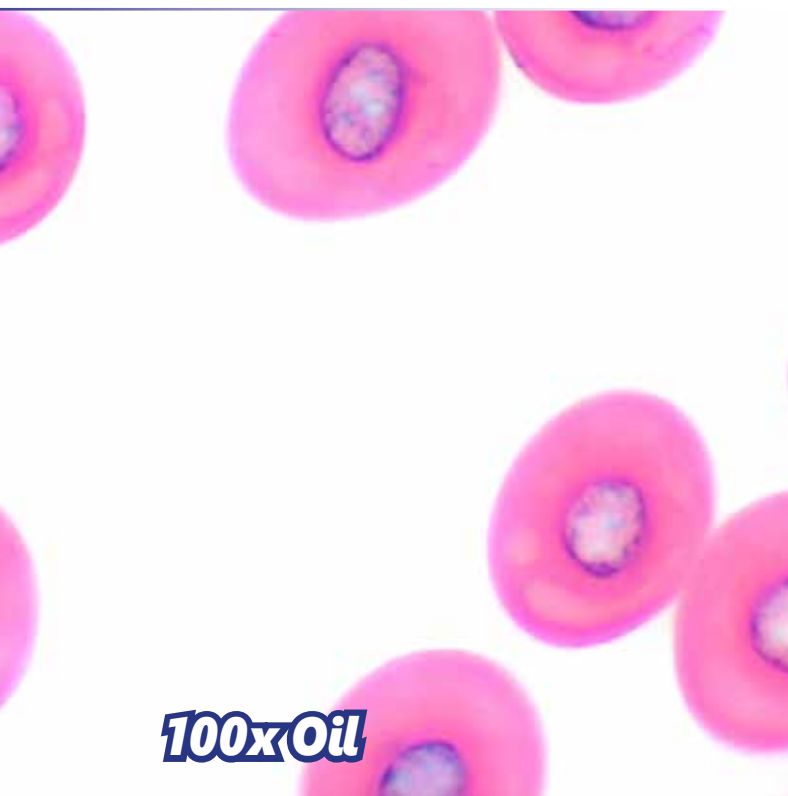

**100x Oil**

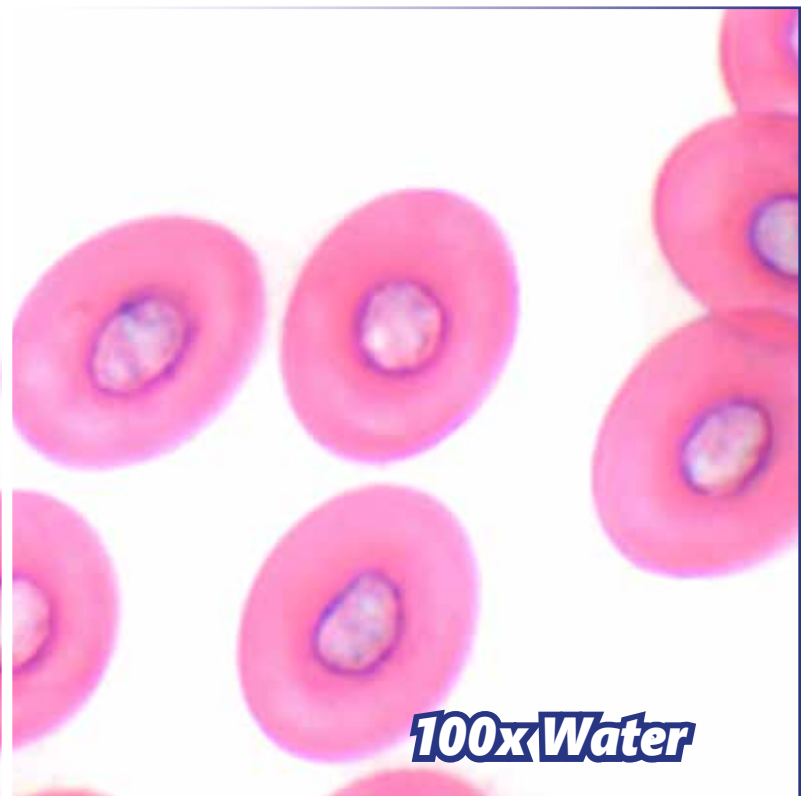

**100x Water**

# X-LED<sup>1</sup> – Only Available at OPTIKA

## POWERFUL AND UNIFORM ILLUMINATION

- » Uncomparable light intensity, exclusive lens and collector design
- » Constant pure-white colour temperature at all intensity levels
- » Unmatched colour fidelity and brightness of your specimen

## MONEY & ENERGY SAVING

- » High energy efficiency at a limited cost, only 1 W
- » More efficient brightness than a 20 W halogen lamp
- » LED long lifetime (65.000 hours = 22 years at 8 hours/day usage)



**Halogen**

**X-LED<sup>1</sup>**



Multi-plug power supply

# ALC – Only Available At OPTIKA

## 3-STEPS EASY SETTING

- » Choose the light intensity you prefer
- » Press the button and set the light
- » Change the objectives or close the diaphragm aperture: the microscope will keep the same light intensity!

## AUTOMATIC LIGHT CONTROL & ADJUSTMENT

- » When another objective is used
- » When the aperture diaphragm changes
- » When processing another sample with different opacity

### STEP 1

Set the brightness according to your preferences.



### STEP 2

Press the ALC button to save the brightness level.



### STEP 3

#### **Forget about the illumination!**

The microscope will automatically adjust the brightness for you, in case of:

- Another objective is used
- The diaphragm aperture is changed
- Another specimen with different opacity is processed



Regulation of diaphragm aperture

# Li-Ion Batteries – Only Available at OPTIKA

1

Educational

## LI-ION BATTERIES PROS (on B-150R models):

- » **Reliable:** Significantly lower self-discharge rate than NiMH
- » **Faster recharge:** Li-Ions can be charged in about 6 hours
- » **Temperature tolerance:** Li-Ion batteries can better stand low temperature and warmer environments compared to NiMH cells
- » **Higher energy density:** Li-Ion batteries carries more charge per gram than NiMH batteries
- » **High number of charges:** Li-Ion batteries can be normally recharged 2000 times with satisfactory quantity of charge
- » **No "Memory Effect":** Li-Ion batteries can be charged at any time, without any "Voltage Depression" effect.

## NIMH BATTERIES CONS (on conventional microscopes):

- » **High self discharge rate:** NiMH lose a large percentage of their charge every month. The number is around 5% on the first week after the charge and about 50% on the first month
- » **Long charging time:** The standard charge time of a NiMH is 12 hours. Fast charging these cells can result in damage
- » **Low number of charges:** NiMH batteries can be normally recharged 500 times with satisfactory quantity of charge
- » **Sensitive "Memory Effect":** NiMH batteries must be charged when totally exhaust only. Charging these batteries when even a small quantity of charge is present, decreases their maximum quantity of charge.





## B-150 Series

The B-150 series has been designed to fulfill all requirements of educational laboratories. Obtain clear images at three (40x, 100x and 400x) or four (40x, 100x, 400x and 600x or 1000x) magnifications with 18mm field number. All in a compact and easy to carry size. The entire series is equipped with 1W X-LED<sup>1</sup> illumination for bright and uniform light. If a cordless microscope is needed, the R Models are your choice as they come with a rechargeable battery.

### Incorporating The Most Wanted Features In A Student Microscope

Get all the controls and features common to higher level microscopes: mechanical stage, binocular head, coaxial focus knob, adjustable condenser, and 1000x maximum magnification. An extremely simple but well-equipped solution, in a modern and ergonomic design.

### The Most Comprehensive Series Dedicated to Students

B-150 comes in a variety of models to meet your needs. Standard brightfield, models with internal rechargeable batteries (R Models), with automatic light control (ALC Models), a version ready for polarization analysis (P Models), and models with built-in camera (D Models) for image acquisition.

### LED With Rechargeable Battery - Optimized Illumination

Money & energy saving thanks to LED long lifetime (65.000 hours, 22 years in case of 8 hours/day) which is more than 20 times compared to a standard halogen bulb.

Rechargeable models are equipped with N-PLAN objectives and have internal lithium rechargeable battery for up to 15 hours (at medium intensity) of outdoor use.

All other models can be equipped with the optional external solar battery pack for field use.



### ALC - Automatic Light Control, Only Available At OPTIKA

#### Incomparable Comfort With The Exclusive Automatic Light Control (ALC)

Light intensity is automatically adjusted by the microscope itself in order to maintain the same level as the one the user has previously chosen. No matter if the aperture of the diaphragm changes, if another objective is used, and if the opacity of the sample is different...the microscope will set the light for you according to your preferences.

On **ALC Models**.

# Middle-Level Biological Microscopes For Students

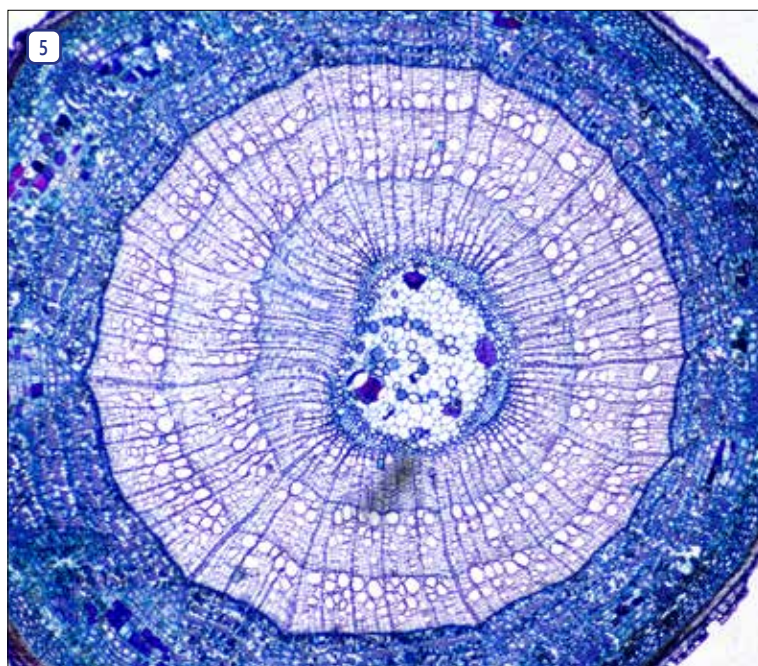
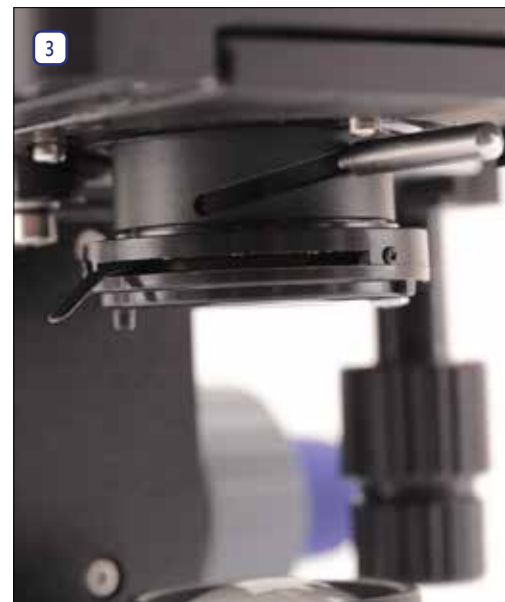
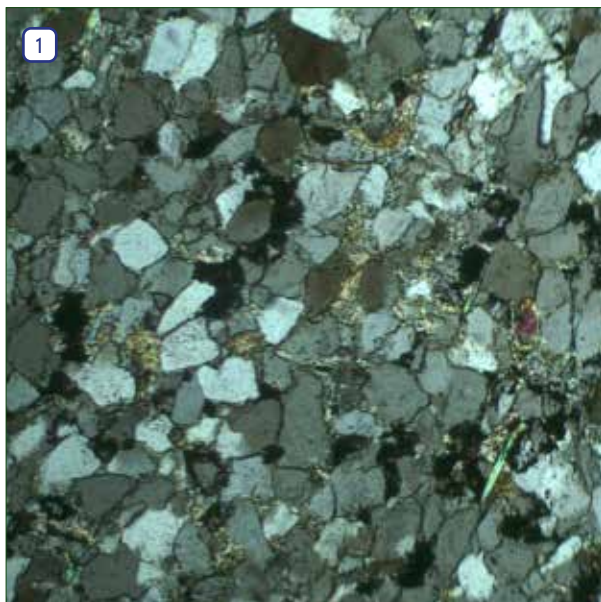

## Legend

1. Polarized light observation of quartzite with B-150P-MRPL and 10x objective.
2. Monocular polarizing microscope B-150P-MRPL during on-site use.
3. B-150 adjustable condenser to concentrate light from the illumination source.
4. Three achromatic objectives (4x, 10x, 40x) of B-151 ensuring great viewing experience.
5. Brightfield observation of tilia three-year stem with B-159 and 20x objective.

# B-150 Series - Standard Models

## B-151



Reliable model with fixed stage and efficient X-LED<sup>1</sup> illumination for ultra-bright images.

**Observation mode:** Brightfield.

**Head:** Monocular, 30° inclined; 360° rotating.

**Eyepiece:** WF10x/18 mm, secured by screw.

**Nosepiece:** Quadruple ball bearings revolving nosepiece.

**Objectives:**

- High Contrast Achromatic 4x/0.10, with anti-fungus treatment
- High Contrast Achromatic 10x/0.25, with anti-fungus treatment
- High Contrast Achromatic 40x/0.65, with anti-fungus treatment

**Specimen stage:** Fixed stage, 130x120 mm. With sample clips.

**Focusing:** Coaxial coarse and fine focusing mechanism with limit stop to prevent the contact between objective and specimen. Adjustable tension of coarse focusing knob.

**Condenser:** N.A. 0.65, pre-centered, fixed with iris diaphragm.

**Illumination:** X-LED<sup>1</sup> with white 1 W LED and light intensity control. Color temperature: 6,300 K. Multi-plug 100-240Vac/5Vdc external power supply.

## B-151ALC



Same as B-151 but with the exclusive **ALC** technology for Automatic Light Control.

**Observation mode:** Brightfield.

**Head:** Monocular, 30° inclined; 360° rotating.

**Eyepiece:** WF10x/18 mm, secured by screw.

**Nosepiece:** Quadruple ball bearings revolving nosepiece.

**Objectives:**

- High Contrast Achromatic 4x/0.10, with anti-fungus treatment
- High Contrast Achromatic 10x/0.25, with anti-fungus treatment
- High Contrast Achromatic 40x/0.65, with anti-fungus treatment

**Specimen stage:** Fixed stage, 130x120 mm. With sample clips.

**Focusing:** Coaxial coarse and fine focusing mechanism with limit stop to prevent the contact between objective and specimen. Adjustable tension of coarse focusing knob.

**Condenser:** N.A. 0.65, pre-centered, fixed with iris diaphragm.

**Illumination:** X-LED<sup>1</sup> with white 1 W LED and light intensity control. Color temperature: 6,300 K. With **ALC** (Automatic Light Control). Multi-plug 100-240Vac/5Vdc external power supply.



# B-150 Series - Standard Models

## B-151R-PL



Same as B-151 but with **N-PLAN** objectives and with rechargeable battery for very long outdoor operation up to 15 hours.

**Observation mode:** Brightfield.

**Head:** Monocular, 30° inclined; 360° rotating.

**Eyepiece:** WF10x/18 mm, secured by screw.

**Nosepiece:** Quadruple ball bearings revolving nosepiece.

**Objectives:**

- N-PLAN 4x/0.10, with anti-fungus treatment
- N-PLAN 10x/0.25, with anti-fungus treatment
- N-PLAN 40x/0.65, with anti-fungus treatment

**Specimen stage:** Fixed stage, 130x120 mm. With sample clips.

**Focusing:** Coaxial coarse and fine focusing mechanism with limit stop to prevent the contact between objective and specimen. Adjustable tension of coarse focusing knob.

**Condenser:** N.A. 0.65, pre-centered, fixed with iris diaphragm.

**Illumination:** X-LED<sup>1</sup> with white 1 W LED and light intensity control. Color temperature: 6,300 K. Li-Ion battery for long lasting operation. Multi-plug 100-240Vac/5Vdc external power supply.

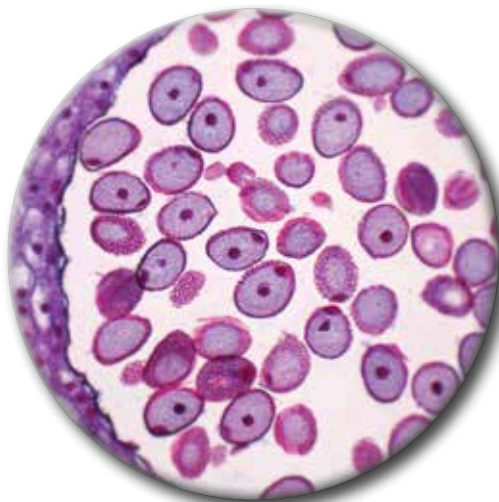

Lily Anther, Mature Pollen Grains, c.s.  
Conventional Achromatic Objective

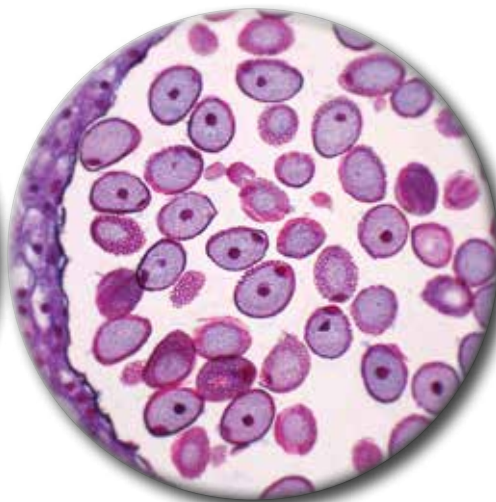

Lily Anther, Mature Pollen Grains, c.s.  
**OPTIKA HC** Objective

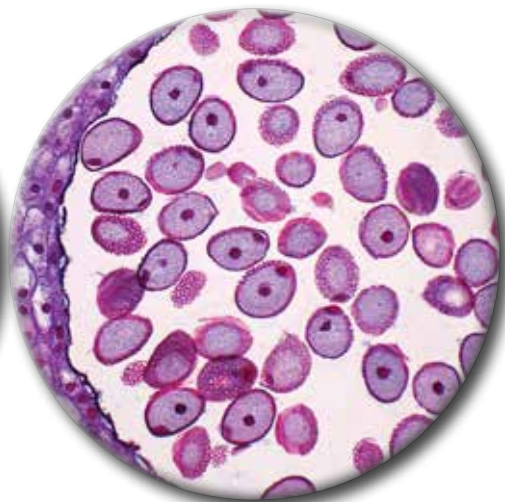

Lily Anther, Mature Pollen Grains, c.s.  
**OPTIKA N-PLAN** Objective



**HC**

**N-PLAN**

**OPTIKA HC:** This series of objectives ensures a versatile and reasonably priced entry-level solution for brightfield and simple polarization applications. They are specifically designed to achieve optimal contrast and thus maximize yield on an instrument intended for education on F.N. 18.

**OPTIKA N-PLAN:** In addition to the advantages of the HC objectives, the total flatness of the field and an even greater contrast are achieved with the N-PLAN series.

# B-150 Series - Standard Models

## B-153



Advanced monocular model with up to 600x total magnification and a precise, accurate positioning of the slide thanks to smooth movement of the mechanical stage. With efficient **X-LED<sup>1</sup>** illumination.

**Observation mode:** Brightfield.

**Head:** Monocular, 30° inclined; 360° rotating.

**Eyepiece:** WF10x/18 mm, secured by screw.

**Nosepiece:** Quadruple ball bearings revolving nosepiece.

**Objectives:**

- High Contrast Achromatic 4x/0.10, with anti-fungus treatment
- High Contrast Achromatic 10x/0.25, with anti-fungus treatment
- High Contrast Achromatic 40x/0.65, with anti-fungus treatment
- High Contrast Achromatic 60x/0.85, with anti-fungus treatment

**Specimen stage:** Mechanical stage, 125x116mm, 70x30 mm X-Y movement range. Vernier scale on the two axes, accuracy: 0.1mm.

**Focusing:** Coaxial coarse and fine focusing mechanism with limit stop to prevent the contact between objective and specimen. Adjustable tension of coarse focusing knob.

**Condenser:** Abbe N.A. 1.25, pre-centered, focusable, with iris diaphragm.

**Illumination:** X-LED<sup>1</sup> with white 1 W LED and light intensity control. Color temperature: 6,300 K. Multi-plug 100-240Vac/5Vdc external power supply.

## B-153ALC



Same as B-153 but with the exclusive ALC technology for Automatic Light Control.

**Observation mode:** Brightfield.

**Head:** Monocular, 30° inclined; 360° rotating.

**Eyepiece:** WF10x/18 mm, secured by screw.

**Nosepiece:** Quadruple ball bearings revolving nosepiece.

**Objectives:**

- High Contrast Achromatic 4x/0.10, with anti-fungus treatment
- High Contrast Achromatic 10x/0.25, with anti-fungus treatment
- High Contrast Achromatic 40x/0.65, with anti-fungus treatment
- High Contrast Achromatic 60x/0.85, with anti-fungus treatment

**Specimen stage:** Mechanical stage, 125x116mm, 70x30 mm X-Y movement range. Vernier scale on the two axes, accuracy: 0.1mm.

**Focusing:** Coaxial coarse and fine focusing mechanism with limit stop to prevent the contact between objective and specimen. Adjustable tension of coarse focusing knob.

**Condenser:** Abbe N.A. 1.25, pre-centered, focusable, with iris diaphragm.

**Illumination:** X-LED<sup>1</sup> with white 1 W LED and light intensity control. Color temperature: 6,300 K. With **ALC** (Automatic Light Control). Multi-plug 100-240Vac/5Vdc external power supply.

# B-150 Series - Standard Models

## B-152R-PL / B-153R-PL



Same as B-153 but with **N-PLAN** objectives and with rechargeable battery for very long outdoor operation up to 15 hours.

**Observation mode:** Brightfield.

**Head:** Monocular, 30° inclined; 360° rotating.

**Eyepiece:** WF10x/18 mm, secured by screw.

**Nosepiece:** Quadruple ball bearings revolving nosepiece.

**Objectives:**

- N-PLAN 4x/0.10, with anti-fungus treatment
- N-PLAN 10x/0.25, with anti-fungus treatment
- N-PLAN 40x/0.65, with anti-fungus treatment
- N-PLAN 60x/0.85, with anti-fungus treatment (only on B-153R-PL)

**Specimen stage:** Mechanical stage, 125x116mm, 70x30 mm X-Y movement range. Vernier scale on the two axes, accuracy: 0.1mm.

**Focusing:** Coaxial coarse and fine focusing mechanism with limit stop to prevent the contact between objective and specimen. Adjustable tension of coarse focusing knob.

**Condenser:** Abbe N.A. 1.25, pre-centered, focusable, with iris diaphragm.

**Illumination:** X-LED<sup>1</sup> with white 1 W LED and light intensity control. Color temperature: 6,300 K. Li-Ion battery for long lasting operation. Multi-plug 100-240Vac/5Vdc external power supply.

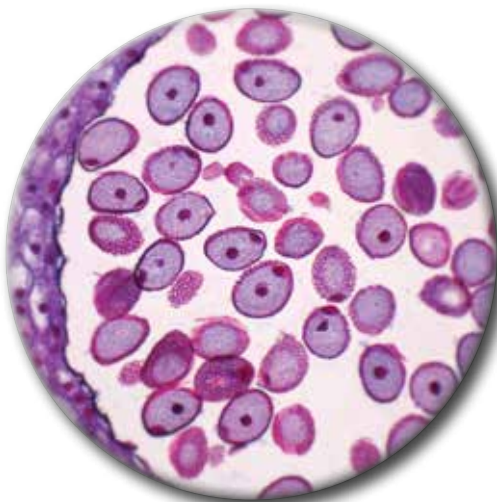

Lily Anther, Mature Pollen Grains, c.s.  
Conventional Achromatic Objective

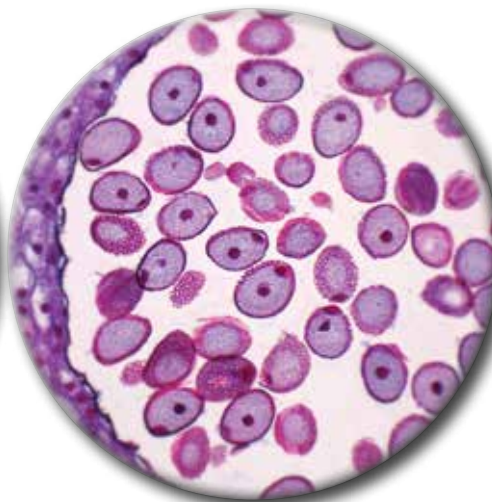

Lily Anther, Mature Pollen Grains, c.s.  
**OPTIKA HC** Objective

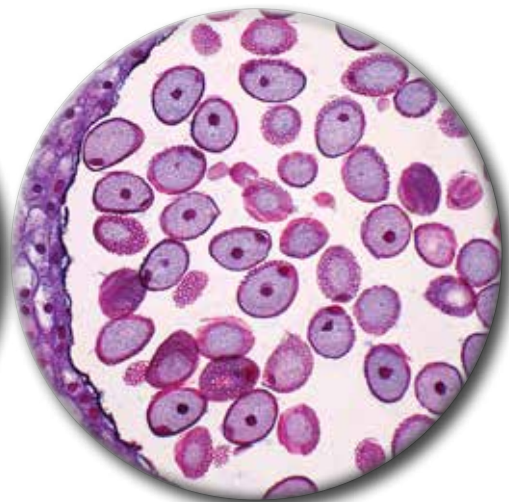

Lily Anther, Mature Pollen Grains, c.s.  
**OPTIKA N-PLAN** Objective



**HC**

**N-PLAN**

**OPTIKA HC:** This series of objectives ensures a versatile and reasonably priced entry-level solution for brightfield and simple polarization applications. They are specifically designed to achieve optimal contrast and thus maximize yield on an instrument intended for education on F.N. 18.

**OPTIKA N-PLAN:** In addition to the advantages of the HC objectives, the total flatness of the field and an even greater contrast are achieved with the N-PLAN series.

# B-150 Series - Standard Models

## B-155



WATER



Advanced monocular model with up to 1000x total magnification and a precise, accurate positioning of the slide thanks to smooth movement of the mechanical stage. With efficient **X-LED<sup>1</sup>** illumination.

**Observation mode:** Brightfield.

**Head:** Monocular, 30° inclined; 360° rotating.

**Eyepiece:** WF10x/18 mm, secured by screw.

**Nosepiece:** Quadruple ball bearings revolving nosepiece.

**Objectives:**

- High Contrast Achromatic 4x/0.10, with anti-fungus treatment
- High Contrast Achromatic 10x/0.25, with anti-fungus treatment
- High Contrast Achromatic 40x/0.65, with anti-fungus treatment
- High Contrast Achromatic 100x/1.25 (Oil/Water), with anti-fungus treat.

**Specimen stage:** Mechanical stage, 125x116mm, 70x30 mm X-Y movement range. Vernier scale on the two axes, accuracy: 0.1mm.

**Focusing:** Coaxial coarse and fine focusing mechanism with limit stop to prevent the contact between objective and specimen. Adjustable tension of coarse focusing knob.

**Condenser:** Abbe N.A. 1.25, pre-centered, focusable, with iris diaphragm.

**Illumination:** X-LED<sup>1</sup> with white 1 W LED and light intensity control. Color temperature: 6,300 K. Multi-plug 100-240Vac/5Vdc external power supply.

## B-155ALC



WATER



Same as B-155 but with the exclusive **ALC** technology for Automatic Light Control.

**Observation mode:** Brightfield.

**Head:** Monocular, 30° inclined; 360° rotating.

**Eyepiece:** WF10x/18 mm, secured by screw.

**Nosepiece:** Quadruple ball bearings revolving nosepiece.

**Objectives:**

- High Contrast Achromatic 4x/0.10, with anti-fungus treatment
- High Contrast Achromatic 10x/0.25, with anti-fungus treatment
- High Contrast Achromatic 40x/0.65, with anti-fungus treatment
- High Contrast Achromatic 100x/1.25 (Oil/Water), with anti-fungus treat.

**Specimen stage:** Mechanical stage, 125x116mm, 70x30 mm X-Y movement range. Vernier scale on the two axes, accuracy: 0.1mm.

**Focusing:** Coaxial coarse and fine focusing mechanism with limit stop to prevent the contact between objective and specimen. Adjustable tension of coarse focusing knob.

**Condenser:** Abbe N.A. 1.25, pre-centered, focusable, with iris diaphragm.

**Illumination:** X-LED<sup>1</sup> with white 1 W LED and light intensity control. Color temperature: 6,300 K. With **ALC** (Automatic Light Control) Multi-plug 100-240Vac/5Vdc external power supply.

# B-150 Series - Standard Models

1

Educational

## B-155R-PL



Same as B-155 but with **N-PLAN** objectives and with rechargeable battery for very long outdoor operation up to 15 hours.

**Observation mode:** Brightfield.

**Head:** Monocular, 30° inclined; 360° rotating.

**Eyepiece:** WF10x/18 mm, secured by screw.

**Nosepiece:** Quadruple ball bearings revolving nosepiece.

**Objectives:**

- N-PLAN 4x/0.10, with anti-fungus treatment
- N-PLAN 10x/0.25, with anti-fungus treatment
- N-PLAN 40x/0.65, with anti-fungus treatment
- N-PLAN 100x/1.25 (Oil/Water), with anti-fungus treatment

**Specimen stage:** Mechanical stage, 125x116mm, 70x30 mm X-Y movement range. Vernier scale on the two axes, accuracy: 0.1mm.

**Focusing:** Coaxial coarse and fine focusing mechanism with limit stop to prevent the contact between objective and specimen. Adjustable tension of coarse focusing knob.

**Condenser:** Abbe N.A. 1.25, pre-centered, focusable, with iris diaphragm.

**Illumination:** X-LED<sup>1</sup> with white 1 W LED and light intensity control. Color temperature: 6,300 K. Li-Ion battery for long lasting operation. Multi-plug 100-240Vac/5Vdc external power supply.

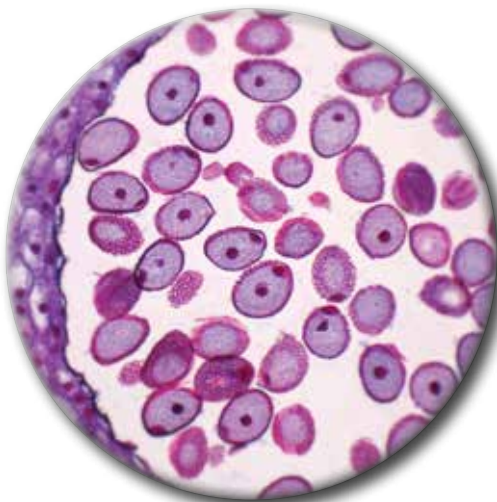

Lily Anther, Mature Pollen Grains, c.s.  
Conventional Achromatic Objective

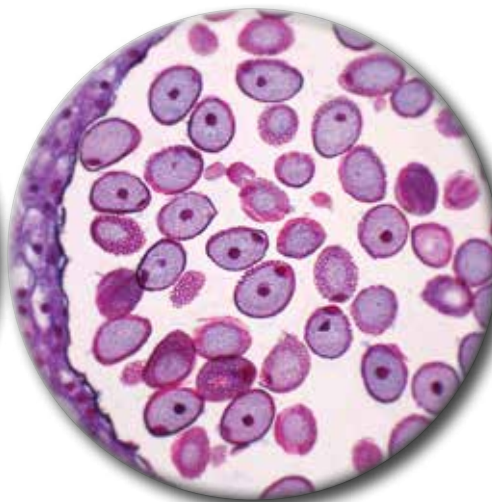

Lily Anther, Mature Pollen Grains, c.s.  
**OPTIKA HC** Objective

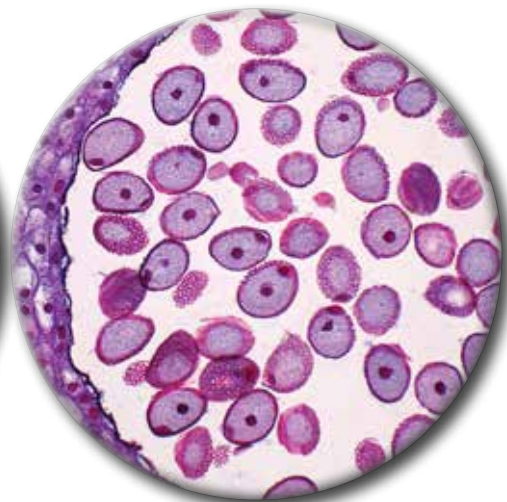

Lily Anther, Mature Pollen Grains, c.s.  
**OPTIKA N-PLAN** Objective



**HC**

**N-PLAN**

**OPTIKA HC:** This series of objectives ensures a versatile and reasonably priced entry-level solution for brightfield and simple polarization applications. They are specifically designed to achieve optimal contrast and thus maximize yield on an instrument intended for education on F.N. 18.

**OPTIKA N-PLAN:** In addition to the advantages of the HC objectives, the total flatness of the field and an even greater contrast are achieved with the N-PLAN series.

# B-150 Series - Standard Models

## B-157



Advanced binocular model with up to 600x total magnification, and a precise and accurate positioning of the slide thanks to smooth movement of the mechanical stage. With efficient **X-LED<sup>1</sup>** illumination.

**Observation mode:** Brightfield.

**Head:** Binocular, 30° inclined; 360° rotating.

**Eyepieces:** WF10x/18 mm, secured by screw.

**Nosepiece:** Quadruple ball bearings revolving nosepiece.

**Objectives:**

- High Contrast Achromatic 4x/0.10 , with anti-fungus treatment
- High Contrast Achromatic 10x/0.25 , with anti-fungus treatment
- High Contrast Achromatic 40x/0.65 , with anti-fungus treatment
- High Contrast Achromatic 60x/0.85 , with anti-fungus treatment

**Specimen stage:** Mechanical stage, 125x116mm, 70x30 mm X-Y movement range. Vernier scale on the two axes, accuracy: 0.1mm.

**Focusing:** Coaxial coarse and fine focusing mechanism with limit stop to prevent the contact between objective and specimen. Adjustable tension of coarse focusing knob.

**Condenser:** Abbe N.A. 1.25, pre-centered, focusable, with iris diaphragm.

**Illumination:** X-LED<sup>1</sup> with white 1 W LED and light intensity control. Color temperature: 6,300 K. Multi-plug 100-240Vac/5Vdc external power supply.

## B-157ALC



Same as B-157 but with the exclusive **ALC** technology for Automatic Light Control.

**Observation mode:** Brightfield.

**Head:** Binocular, 30° inclined; 360° rotating.

**Eyepieces:** WF10x/18 mm, secured by screw.

**Nosepiece:** Quadruple ball bearings revolving nosepiece.

**Objectives:**

- High Contrast Achromatic 4x/0.10 , with anti-fungus treatment
- High Contrast Achromatic 10x/0.25 , with anti-fungus treatment
- High Contrast Achromatic 40x/0.65 , with anti-fungus treatment
- High Contrast Achromatic 60x/0.85 , with anti-fungus treatment

**Specimen stage:** Mechanical stage, 125x116mm, 70x30 mm X-Y movement range. Vernier scale on the two axes, accuracy: 0.1mm.

**Focusing:** Coaxial coarse and fine focusing mechanism with limit stop to prevent the contact between objective and specimen. Adjustable tension of coarse focusing knob.

**Condenser:** Abbe N.A. 1.25, pre-centered, focusable, with iris diaphragm.

**Illumination:** X-LED<sup>1</sup> with white 1 W LED and light intensity control. Color temperature: 6,300 K. With **ALC** (Automatic Light Control). Multi-plug 100-240Vac/5Vdc external power supply.

# B-150 Series - Standard Models

## B-157R-PL



Same as B-157 but with **N-PLAN** objectives and with rechargeable battery for very long outdoor operation up to 15 hours.

**Observation mode:** Brightfield.

**Head:** Binocular, 30° inclined; 360° rotating.

**Eyepieces:** WF10x/18 mm, secured by screw.

**Nosepiece:** Quadruple ball bearings revolving nosepiece.

**Objectives:**

- N-PLAN 4x/0.10 , with anti-fungus treatment
- N-PLAN 10x/0.25 , with anti-fungus treatment
- N-PLAN 40x/0.65 , with anti-fungus treatment
- N-PLAN 60x/0.85 , with anti-fungus treatment

**Specimen stage:** Mechanical stage, 125x116mm, 70x30 mm X-Y movement range. Vernier scale on the two axes, accuracy: 0.1mm.

**Focusing:** Coaxial coarse and fine focusing mechanism with limit stop to prevent the contact between objective and specimen. Adjustable tension of coarse focusing knob.

**Condenser:** Abbe N.A. 1.25, pre-centered, focusable, with iris diaphragm.

**Illumination:** X-LED<sup>1</sup> with white 1 W LED and light intensity control. Color temperature: 6,300 K. Li-Ion battery for long lasting operation. Multi-plug 100-240Vac/5Vdc external power supply.

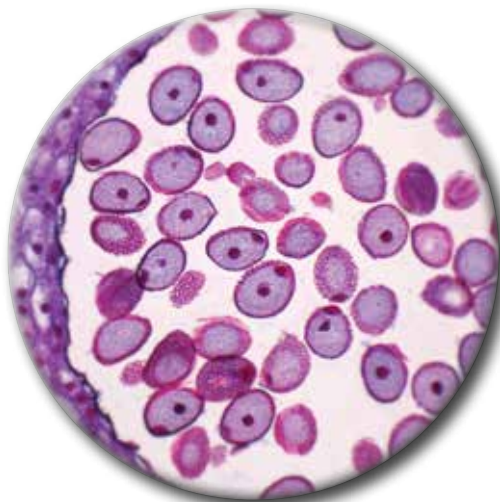

Lily Anther, Mature Pollen Grains, c.s  
Conventional Achromatic Objective

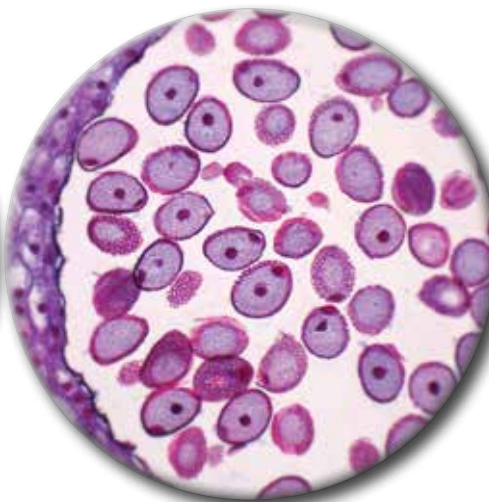

Lily Anther, Mature Pollen Grains, c.s  
**OPTIKA HC** Objective

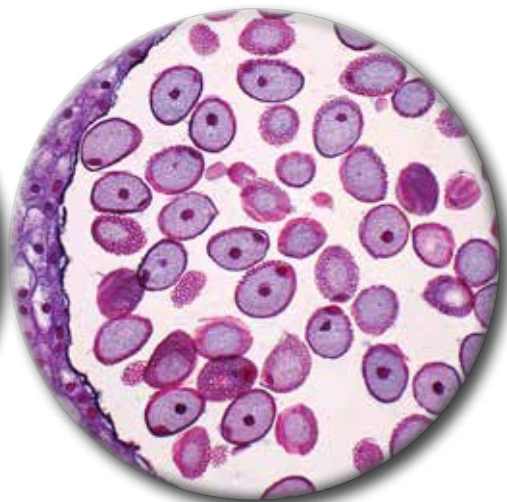

Lily Anther, Mature Pollen Grains, c.s  
**OPTIKA N-PLAN** Objective



**HC**

**N-PLAN**

**OPTIKA HC:** This series of objectives ensures a versatile and reasonably priced entry-level solution for brightfield and simple polarization applications. They are specifically designed to achieve optimal contrast and thus maximize yield on an instrument intended for education on F.N. 18.

**OPTIKA N-PLAN:** In addition to the advantages of the HC objectives, the total flatness of the field and an even greater contrast are achieved with the N-PLAN series.

# B-150 Series - Standard Models

## B-159



Advanced binocular model with up to 1000x total magnification and a precise and accurate positioning of the slide thanks to smooth movement of the mechanical stage. With efficient **X-LED<sup>1</sup>** illumination.

**Observation mode:** Brightfield.

**Head:** Binocular, 30° inclined; 360° rotating.

**Eyepieces:** WF10x/18 mm, secured by screw.

**Nosepiece:** Quadruple ball bearings revolving nosepiece.

**Objectives:**

- High Contrast Achromatic 4x/0.10, with anti-fungus treatment
- High Contrast Achromatic 10x/0.25, with anti-fungus treatment
- High Contrast Achromatic 40x/0.65, with anti-fungus treatment
- High Contrast Achromatic 100x/1.25 (Oil/Water), with anti-fungus treat.

**Specimen stage:** Mechanical stage, 125x116mm, 70x30 mm X-Y movement range. Vernier scale on the two axes, accuracy: 0.1mm.

**Focusing:** Coaxial coarse and fine focusing mechanism with limit stop to prevent the contact between objective and specimen. Adjustable tension of coarse focusing knob.

**Condenser:** Abbe N.A. 1.25, pre-centered, focusable, with iris diaphragm.

**Illumination:** X-LED<sup>1</sup> with white 1 W LED and light intensity control. Color temperature: 6,300 K. Multi-plug 100-240Vac/5Vdc external power supply.

## B-159ALC



Same as B-159 but with the exclusive **ALC** technology for Automatic Light Control.

**Observation mode:** Brightfield.

**Head:** Binocular, 30° inclined; 360° rotating.

**Eyepieces:** WF10x/18 mm, secured by screw.

**Objectives:**

- High Contrast Achromatic 4x/0.10, with anti-fungus treatment
- High Contrast Achromatic 10x/0.25, with anti-fungus treatment
- High Contrast Achromatic 40x/0.65, with anti-fungus treatment
- High Contrast Achromatic 100x/1.25 (Oil/Water), with anti-fungus treat.

**Specimen stage:** Mechanical stage, 125x116mm, 70x30 mm X-Y movement range. Vernier scale on the two axes, accuracy: 0.1mm.

**Focusing:** Coaxial coarse and fine focusing mechanism with limit stop to prevent the contact between objective and specimen. Adjustable tension of coarse focusing knob.

**Condenser:** Abbe N.A. 1.25, pre-centered, focusable, with iris diaphragm.

**Illumination:** X-LED<sup>1</sup> with white 1 W LED and light intensity control. Color temperature: 6,300 K. With **ALC** (Automatic Light Control). Multi-plug 100-240Vac/5Vdc external power supply.



# B-150 Series - Standard Models

## B-159R-PL



Same as B-159 but with **N-PLAN** objectives and with rechargeable battery for very long outdoor operation up to 15 hours.

**Observation mode:** Brightfield.

**Head:** Binocular, 30° inclined; 360° rotating.

**Eyepieces:** WF10x/18 mm, secured by screw.

**Nosepiece:** Quadruple ball bearings revolving nosepiece.

**Objectives:**

- N-PLAN 4x/0.10 , with anti-fungus treatment
- N-PLAN 10x/0.25 , with anti-fungus treatment
- N-PLAN 40x/0.65 , with anti-fungus treatment
- N-PLAN 100x/1.25 (Oil/Water) , with anti-fungus treatment

**Specimen stage:** Mechanical stage, 125x116mm, 70x30 mm X-Y movement range. Vernier scale on the two axes, accuracy: 0.1mm.

**Focusing:** Coaxial coarse and fine focusing mechanism with limit stop to prevent the contact between objective and specimen. Adjustable tension of coarse focusing knob.

**Condenser:** Abbe N.A. 1.25, pre-centered, focusable, with iris diaphragm.

**Illumination:** X-LED<sup>1</sup> with white 1 W LED and light intensity control. Color temperature: 6,300 K. Li-Ion battery for long lasting operation. Multi-plug 100-240Vac/5Vdc external power supply.

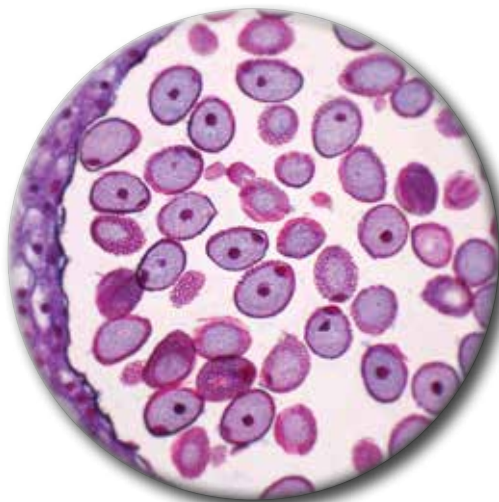

Lily Anther, Mature Pollen Grains, c.s.  
Conventional Achromatic Objective

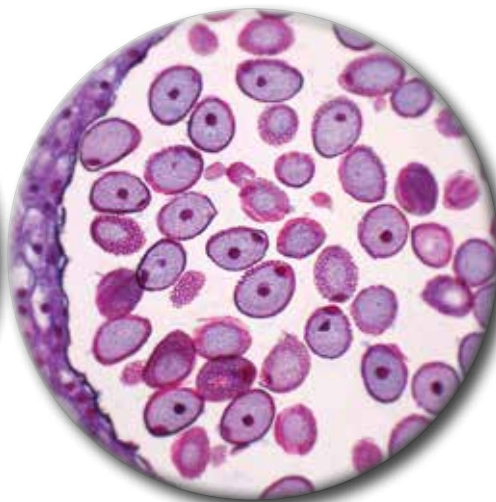

Lily Anther, Mature Pollen Grains, c.s.  
**OPTIKA HC** Objective

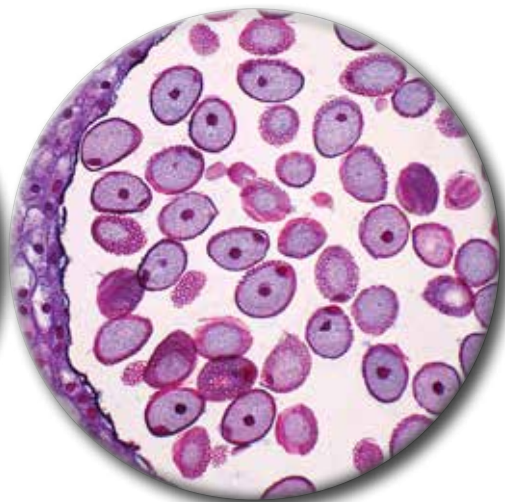

Lily Anther, Mature Pollen Grains, c.s.  
**OPTIKA N-PLAN** Objective



**HC**

**N-PLAN**

**OPTIKA HC:** This series of objectives ensures a versatile and reasonably priced entry-level solution for brightfield and simple polarization applications. They are specifically designed to achieve optimal contrast and thus maximize yield on an instrument intended for education on F.N. 18.

**OPTIKA N-PLAN:** In addition to the advantages of the HC objectives, the total flatness of the field and an even greater contrast are achieved with the N-PLAN series.

# B-150 Series - Polarizing Models

## B-150P-MRPL



Monocular polarizing microscope with rechargeable battery for very long outdoor operation up to 15 hours. Equipped with rotatable stage and efficient **X-LED'** illumination. With **N-PLAN** objectives.

**Observation mode:** Brightfield, Polarized Light.

**Head:** Monocular, 30° inclined; 360° rotating.

**Eyepiece:** WF10x/18 mm, secured by screw.

**Nosepiece:** Quadruple ball bearings revolving nosepiece.

**Objectives:**

- N-PLAN 4x/0.10, with anti-fungus treatment
- N-PLAN 10x/0.25, with anti-fungus treatment
- N-PLAN 40x/0.65, with anti-fungus treatment

**Specimen stage:** Rotatable round stage, 120 mm diameter.

**Focusing:** Coaxial coarse and fine focusing mechanism with limit stop to prevent the contact between objective and specimen. Adjustable tension of coarse focusing knob.

**Condenser:** N.A. 1.25, pre-centered, fixed with iris diaphragm.

**Illumination:** X-LED' with white 1 W LED and light intensity control. Color temperature: 6,300 K. Li-Ion battery for long lasting operation. Multi-plug 100-240Vac/5Vdc external power supply.

**Polarizing filters:** Rotating Polarizer (swing-out) and fixed Analyzer (sliding-out).

## B-150P-BRPL



Binocular polarizing microscope with rechargeable battery for very long outdoor operation up to 15 hours. Equipped with rotatable stage and efficient **X-LED'** illumination. With **N-PLAN** objectives.

**Observation modes:** Brightfield, Polarized Light.

**Head:** Binocular, 30° inclined; 360° rotating.

**Eyepieces:** WF10x/18 mm, secured by screw.

**Nosepiece:** Quadruple ball bearings revolving nosepiece.

**Objectives:**

- N-PLAN 4x/0.10, with anti-fungus treatment
- N-PLAN 10x/0.25, with anti-fungus treatment
- N-PLAN 40x/0.65, with anti-fungus treatment

**Specimen stage:** Rotatable round stage, 120 mm diameter.

**Focusing:** Coaxial coarse and fine focusing mechanism with limit stop to prevent the contact between objective and specimen. Adjustable tension of coarse focusing knob.

**Condenser:** N.A. 1.25, pre-centered, fixed with iris diaphragm.

**Illumination:** X-LED' with white 1 W LED and light intensity control. Color temperature: 6,300 K. Li-Ion battery for long lasting operation. Multi-plug 100-240Vac/5Vdc external power supply.

**Polarizing filters:** Rotating Polarizer (swing-out) and fixed Analyzer (sliding-out).

# B-150 Series - Digital Models

1

Educational

## B-150D-MRPL



Monocular digital microscope with rechargeable battery for very long outdoor operation up to 15 hours. Equipped with mechanical stage and efficient **X-LED** illumination. With **N-PLAN** objectives.

**Observation mode:** Brightfield.

**Head:** Monocular, 30° inclined; 360° rotating. With integrated 1.3 MP camera.

**Eyepiece:** WF10x/18 mm, secured by screw.

**Nosepiece:** Quadruple ball bearings revolving nosepiece.

**Objectives:**

- N-PLAN 4x/0.10 , with anti-fungus treatment
- N-PLAN 10x/0.25 , with anti-fungus treatment
- N-PLAN 40x/0.65 , with anti-fungus treatment

**Specimen stage:** Mechanical stage, 125x116mm, 70x30 mm X-Y movement range. Vernier scale on the two axes, accuracy: 0.1mm.

**Focusing:** Coaxial coarse and fine focusing mechanism with limit stop to prevent the contact between objective and specimen. Adjustable tension of coarse focusing knob.

**Condenser:** Abbe N.A. 1.25, pre-centered, focusable, with iris diaphragm.

**Illumination:** X-LED<sup>1</sup> with white 1 W LED and light intensity control. Color temperature: 6,300 K. Li-Ion battery for long lasting operation. Multi-plug 100-240Vac/5Vdc external power supply.

## B-150D-BRPL



Binocular digital microscope with up to 1000x total magnifications and rechargeable battery for very long outdoor operation. Equipped with mechanical stage, efficient **X-LED** illumination and **N-PLAN** objectives.

**Observation mode:** Brightfield.

**Head:** Binocular, 30° inclined; 360° rotating. With integrated 3.1 MP camera.

**Eyepieces:** WF10x/18 mm, secured by screw.

**Nosepiece:** Quadruple ball bearings revolving nosepiece.

**Objectives:**

- N-PLAN 4x/0.10 , with anti-fungus treatment
- N-PLAN 10x/0.25 , with anti-fungus treatment
- N-PLAN 40x/0.65 , with anti-fungus treatment
- N-PLAN 100x/1.25 (Oil/Water) , with anti-fungus treatment

**Specimen stage:** Mechanical stage, 125x116mm, 70x30 mm X-Y movement range. Vernier scale on the two axes, accuracy: 0.1mm.

**Focusing:** Coaxial coarse and fine focusing mechanism with limit stop to prevent the contact between objective and specimen. Adjustable tension of coarse focusing knob.

**Condenser:** Abbe N.A. 1.25, pre-centered, focusable, with iris diaphragm.

**Illumination:** X-LED<sup>1</sup> with white 1 W LED and light intensity control. Color temperature: 6,300 K. Li-Ion battery for long lasting operation. Multi-plug 100-240Vac/5Vdc external power supply.

# B-150 Series - B-150D Camera specifications

	B-150D-MRPL	B-150D-BRPL
Resolution	1280x1024 pixels (1.3 MP)	2048x1536 pixels (3.14 MP)
Sensor	1/3.2" CMOS	1/2.5" CMOS
Pixel size	2.8x2.8 μm	2.2x2.2 μm
Resolution & Frame Rate	1280x1024 - 15 fps	2048x1536 - 4 fps
	640x480 - 30 fps	1280x1024 - 8 fps
		640x480 - 30 fps
Sensitivity	1.0 V/Lux-sec	0.53 V/Lux-sec
White Balance	Auto / Manual	Auto / Manual
S/N Ratio	≥ 40 dB	≥ 40 dB
Dynamic Range	≥ 66.5 dB	≥ 66.5 dB
Digital Port	USB 2.0	USB 2.0
Imaging Software	OPTIKA Vision Lite	OPTIKA Vision Lite
System Requirements	Operating system: Windows XP, Vista, Win7, Win8, Win10, 32-64 bit	

## B-150 Series - Optical performance

Eyepiece		10x (M-002.1)			16x (M-003)	
Field number (mm)			18		12	
Objective	N.A.	W.D. (mm)	Total magnification	Field of View (mm)	Total magnification	Field of View (mm)
4x	0.1	18	40x	4.5	64x	3
10x	0.25	7	100x	1.8	160x	1.2
20x	0.4	2	200x	0.9	320x	0.6
40x	0.65	0.53	400x	0.45	640x	0.3
60x	0.8	0.45	600x	0.3	960x	0.2
100x	1.25 (oil/water)	0.13	1000x	0.18	1600x	0.12

## B-150 Series - Zoom comparison

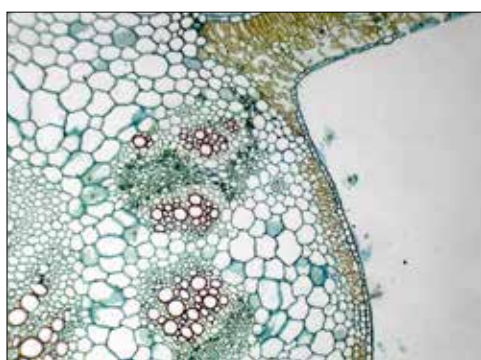

Monocot and dicot - B-157 - 4x objective

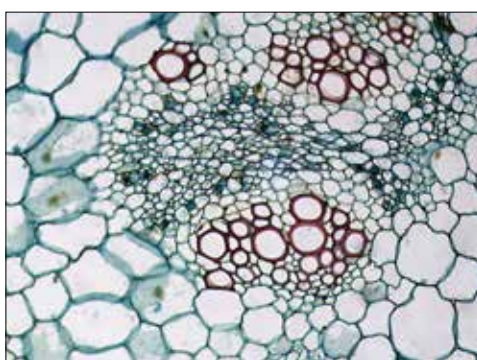

Monocot and dicot - B-157 - 10x objective

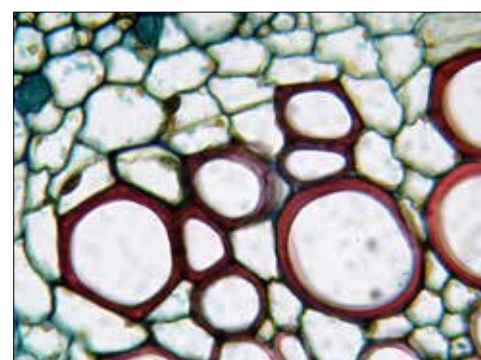

Monocot and dicot - B-157 - 40x objective

# B-150 Series - Comparison charts

1

Educational

## B-150 - Standard Models, with HC Objectives

Model	Head	Eyepiece(s)	Nosepiece	Objectives	Stage	Focusing	Condenser	Illumination
<b>B-151</b>	Monocular, 30° inclined, 360° rotating	WF 10x/18	Quadruple	HC (high contrast) 4x, 10x, 40x	Fixed, 130x120 mm, with sample clips	Coaxial coarse and fine, limit stop	N.A. 0.65, iris diaphragm, fixed	1 W X-LED <sup>1</sup> , manual brightness control
<b>B-153</b>	Monocular, 30° inclined, 360° rotating	WF 10x/18	Quadruple	HC (high contrast) 4x, 10x, 40x, 60x	Double layer, 125x116 mm, moving range 70x30 mm	Coaxial coarse and fine, limit stop	Abbe N.A. 1.25, iris diaphragm, focusable	1 W X-LED <sup>1</sup> , manual brightness control
<b>B-155</b>	Monocular, 30° inclined, 360° rotating	WF 10x/18	Quadruple	HC (high contrast) 4x, 10x, 40x, 100x	Double layer, 125x116 mm, moving range 70x30 mm	Coaxial coarse and fine, limit stop	Abbe N.A. 1.25, iris diaphragm, focusable	1 W X-LED <sup>1</sup> , manual brightness control
<b>B-157</b>	Binocular, 30° inclined, 360° rotating	WF 10x/18	Quadruple	HC (high contrast) 4x, 10x, 40x, 60x	Double layer, 125x116 mm, moving range 70x30 mm	Coaxial coarse and fine, limit stop	Abbe N.A. 1.25, iris diaphragm, focusable	1 W X-LED <sup>1</sup> , manual brightness control
<b>B-159</b>	Binocular, 30° inclined, 360° rotating	WF 10x/18	Quadruple	HC (high contrast) 4x, 10x, 40x, 100x	Double layer, 125x116 mm, moving range 70x30 mm	Coaxial coarse and fine, limit stop	Abbe N.A. 1.25, iris diaphragm, focusable	1 W X-LED <sup>1</sup> , manual brightness control

## B-150 - ALC Models, with Automatic Light Control and HC Objectives

Model	Head	Eyepiece(s)	Nosepiece	Objectives	Stage	Focusing	Condenser	Illumination
<b>B-151ALC</b>	Monocular, 30° inclined	WF 10x/18	Quadruple	HC (high contrast) 4x, 10x, 40x	Fixed, 130x120 mm, with sample clips	Coaxial coarse and fine, limit stop	N.A. 0.65 fixed, with diaphragm	1 W X-LED <sup>1</sup> , manual and <b>automatic brightness control</b>
<b>B-153ALC</b>	Monocular, 30° inclined	WF 10x/18	Quadruple	HC (high contrast) 4x, 10x, 40x, 60x	Double layer, 125x116 mm, moving range 70x30 mm	Coaxial coarse and fine, limit stop	Abbe N.A. 1.25, iris diaphragm, focusable	1 W X-LED <sup>1</sup> , manual and <b>automatic brightness control</b>
<b>B-155ALC</b>	Monocular, 30° inclined	WF 10x/18	Quadruple	HC (high contrast) 4x, 10x, 40x, 100x	Double layer, 125x116 mm, moving range 70x30 mm	Coaxial coarse and fine, limit stop	Abbe N.A. 1.25, iris diaphragm, focusable	1 W X-LED <sup>1</sup> , manual and <b>automatic brightness control</b>
<b>B-157ALC</b>	Binocular, 30° inclined	WF 10x/18	Quadruple	HC (high contrast) 4x, 10x, 40x, 60x	Double layer, 125x116 mm, moving range 70x30 mm	Coaxial coarse and fine, limit stop	Abbe N.A. 1.25, iris diaphragm, focusable	1 W X-LED <sup>1</sup> , manual and <b>automatic brightness control</b>
<b>B-159ALC</b>	Binocular, 30° inclined	WF 10x/18	Quadruple	HC (high contrast) 4x, 10x, 40x, 100x	Double layer, 125x116 mm, moving range 70x30 mm	Coaxial coarse and fine, limit stop	Abbe N.A. 1.25, iris diaphragm, focusable	1 W X-LED <sup>1</sup> , manual and <b>automatic brightness control</b>

## B-150 - Cordless Models, with N-PLAN Objectives and Li-Ion Rechargeable Batteries

Model	Head	Eyepiece(s)	Nosepiece	Objectives	Stage	Focusing	Condenser	Illumination
<b>B-151R-PL</b>	Monocular, 30° inclined, 360° rotating	WF 10x/18	Quadruple	<b>N-PLAN</b> 4x, 10x, 40x	Fixed, 130x120 mm, with sample clips	Coaxial coarse and fine, limit stop	N.A. 0.65 fixed, with diaphragm	1 W X-LED <sup>1</sup> , manual brightness control, <b>Li-Ion</b> rechargeable battery
<b>B-152R-PL</b>	Monocular, 30° inclined, 360° rotating	WF 10x/18	Quadruple	<b>N-PLAN</b> 4x, 10x, 40x	Double layer, 125x116 mm, moving range 70x30 mm	Coaxial coarse and fine, limit stop	Abbe N.A. 1.25, iris diaphragm, focusable	1 W X-LED <sup>1</sup> , manual brightness control, <b>Li-Ion</b> rechargeable battery
<b>B-153R-PL</b>	Monocular, 30° inclined, 360° rotating	WF 10x/18	Quadruple	<b>N-PLAN</b> 4x, 10x, 40x, 60x	Double layer, 125x116 mm, moving range 70x30 mm	Coaxial coarse and fine, limit stop	Abbe N.A. 1.25, iris diaphragm, focusable	1 W X-LED <sup>1</sup> , manual brightness control, <b>Li-Ion</b> rechargeable battery
<b>B-155R-PL</b>	Monocular, 30° inclined, 360° rotating	WF 10x/18	Quadruple	<b>N-PLAN</b> 4x, 10x, 40x, 100x	Double layer, 125x116 mm, moving range 70x30 mm	Coaxial coarse and fine, limit stop	Abbe N.A. 1.25, iris diaphragm, focusable	1 W X-LED <sup>1</sup> , manual brightness control, <b>Li-Ion</b> rechargeable battery
<b>B-157R-PL</b>	Binocular, 30° inclined, 360° rotating	WF 10x/18	Quadruple	<b>N-PLAN</b> 4x, 10x, 40x, 60x	Double layer, 125x116 mm, moving range 70x30 mm	Coaxial coarse and fine, limit stop	Abbe N.A. 1.25, iris diaphragm, focusable	1 W X-LED <sup>1</sup> , manual brightness control, <b>Li-Ion</b> rechargeable battery
<b>B-159R-PL</b>	Binocular, 30° inclined, 360° rotating	WF 10x/18	Quadruple	<b>N-PLAN</b> 4x, 10x, 40x, 100x	Double layer, 125x116 mm, moving range 70x30 mm	Coaxial coarse and fine, limit stop	Abbe N.A. 1.25, iris diaphragm, focusable	1 W X-LED <sup>1</sup> , manual brightness control, <b>Li-Ion</b> rechargeable battery

## B-150 - Polarized Light Cordless Models, with N-PLAN Objectives and Li-Ion Rechargeable Batteries

Model	Head	Eyepiece(s)	Nosepiece	Objectives	Stage	Focusing	Condenser	Illumination
<b>B-150P-MRPL</b>	Monocular, 30° inclined, 360° rotating	WF 10x/18	Quadruple	<b>N-PLAN</b> 4x, 10x, 40x	Round, 360° rotating, 120 mm diameter, with sample clips	Coaxial coarse and fine, limit stop	N.A. 1.25, iris diaphragm, fixed	1 W X-LED <sup>1</sup> , manual brightness control, <b>Li-Ion</b> rechargeable battery
<b>B-150P-BRPL</b>	Binocular, 30° inclined, 360° rotating	WF 10x/18	Quadruple	<b>N-PLAN</b> 4x, 10x, 40x	Round, 360° rotating, 120 mm diameter, with sample clips	Coaxial coarse and fine, limit stop	N.A. 1.25, iris diaphragm, fixed	1 W X-LED <sup>1</sup> , manual brightness control, <b>Li-Ion</b> rechargeable battery

## B-150 - Digital Cordless Models, with N-PLAN Objectives and Li-Ion Rechargeable Batteries

Model	Head	Eyepiece(s)	Nosepiece	Objectives	Stage	Focusing	Condenser	Illumination
<b>B-150D-MRPL</b>	Monocular, 30° inclined, 360° rotating	WF 10x/18	Quadruple	<b>N-PLAN</b> 4x, 10x, 40x	Double layer, 125x116 mm, moving range 70x30 mm	Coaxial coarse and fine, limit stop	Abbe N.A. 1.25, iris diaphragm, focusable	1 W X-LED <sup>1</sup> , manual brightness control, <b>Li-Ion</b> rechargeable battery
<b>B-150D-BRPL</b>	Binocular, 30° inclined, 360° rotating	WF 10x/18	Quadruple	<b>N-PLAN</b> 4x, 10x, 40x, 100x	Double layer, 125x116 mm, moving range 70x30 mm	Coaxial coarse and fine, limit stop	Abbe N.A. 1.25, iris diaphragm, focusable	1 W X-LED <sup>1</sup> , manual brightness control, <b>Li-Ion</b> rechargeable battery

# B-150 Series - Accessories

## Eyecups & Eyepieces

M-001	Huygens 5x eyepiece
M-002.1	WF10x/18 eyepiece, high eyepoint
M-004	WF10x/18 micrometric eyepiece, high eyepoint
M-008	WF10x/18 eyepiece, high eyepoint, with pointer
M-003	WF16x/12 eyepiece
M-162	WF20x/10 eyepiece

## Objectives & Additional Lenses

### HC

M-137	HC (high contrast) objective 4x/0.10
M-138	HC (high contrast) objective 10x/0.25
M-139	HC (high contrast) objective 20x/0.40
M-141	HC (high contrast) objective 40x/0.65
M-142	HC (high contrast) objective 60x/0.85
M-143	HC (high contrast) objective 100x/1.25 (oil)

### N-PLAN

M-164	N-PLAN objective 4x/0.10
M-165	N-PLAN objective 10x/0.25
M-166	N-PLAN objective 20x/0.40
M-167	N-PLAN objective 40x/0.65
M-168	N-PLAN objective 60x/0.85
M-169	N-PLAN objective 100x/1.25 (oil)

## Stages

M-040	Attachable mechanical stage (only for B-151, B-151ALC and B-151R-PL)
-------	--

## Condensers & Filters

M-974	Blue filter, 32mm diameter
M-976	Green filter, 32mm diameter
M-978	Yellow filter, 32mm diameter
M-988	Frosted glass filter, 32mm diameter
M-155	Polarising set (filters only)

## Camera Adapters

M-115	0.35x C-Mount projection lens
M-114	0.5x C-Mount projection lens
M-118	0.75x C-Mount projection lens

## Miscellaneous

15104	Cleaning kit
15008	Immersion oil, 10ml
15009	Immersion oil, 100ml
DC-002	Plastic dust cover, medium, 490(l)x490(h) mm
M-005	Micrometric slide, 26x76mm, with 2 scales (1mm/100 & 10mm/100)
M-069	Solar charger
M-972	Plane-concave mirror, with base

## M-069 - Solar charger

Included battery: rechargeable – Lithium-Poly. Capacity: 2600 mAh. Output voltage: 5,5Vdc. - Dimensions: 120x73x10 mm. Autonomy: over 6 hours at medium intensity (X-LED<sup>3</sup>). Charging modes: with solar panel (12h), with external USB power supply (not included) or from PC USB port (5h). Not compatible with R models.



## 15104 - Cleaning kit

It cleans glass quickly and effectively, without leaving residue or odor. Ideal for precision lens or prism cleaning.



### How to connect the cameras to our microscopes.

Please refer to the Adapter reference list on Digital section.

v 1.4.0 - OPTIKA reserves the right to make corrections, modifications, enhancements, improvements and other changes to its products at any time without notice.

## Headquarters and Manufacturing Facilities

**OPTIKA® S.r.l.** Via Rigla, 30 - 24010 Ponteranica (BG) - ITALY - Tel.: +39 035.571.392 - info@optikamicroscopes.com

## Optika Sales branches

**OPTIKA® Spain** spain@optikamicroscopes.com  
**OPTIKA® China** china@optikamicroscopes.com  
**OPTIKA® India** india@optikamicroscopes.com

**OPTIKA® USA** usa@optikamicroscopes.com  
**OPTIKA® Central America** camerica@optikamicroscopes.com

## B-190 Series



**Advanced Biological Microscopes For Students**



# Fulfill the Next Generation Learning Challenges

## FOR SKILLFUL STUDENTS AND CLASSROOM USE

- » Extremely reliable microscopes for educational purposes
- » Particularly recommended for secondary school
- » Ideal for teaching and learning biology

## YOUR FAVOURITE EDUCATIONAL MICROSCOPES

- » Choose among monocular, binocular and trinocular heads
- » 18mm field number
- » Achromatic lenses for standard brightfield applications





# B-190TB - A Completely New, Revolutionary Experience

## HANDY, YET EXTREMELY STABLE

- » Get accurate, dependable results in one click
- » Equipped with the most reliable OS, Windows 10
- » Holding solution for open discussion, 360° rotating and tilting

## OPTIMUM AND UNPARALLELED COMFORT IN USE

- » Large touch screen with fast, responsive and smooth control
- » Simultaneous camera and power connection for long-term operation
- » Easily detachable, can be used as a laptop (keyboard included)



# 100x With Water – A New Frontier In Education

## SAME OBJECTIVE FOR OIL AND WATER USE

- » Oil represents the best media for high numerical apertures
- » Water combines relevant results with convenience
- » Water is recommended especially for educational purposes

## UNPARALLELED TIME & MONEY SAVINGS

- » Save time by forgetting about tedious cleaning
- » No time-wasting procedures
- » No additional expenses due to inappropriate cleaning & maintenance

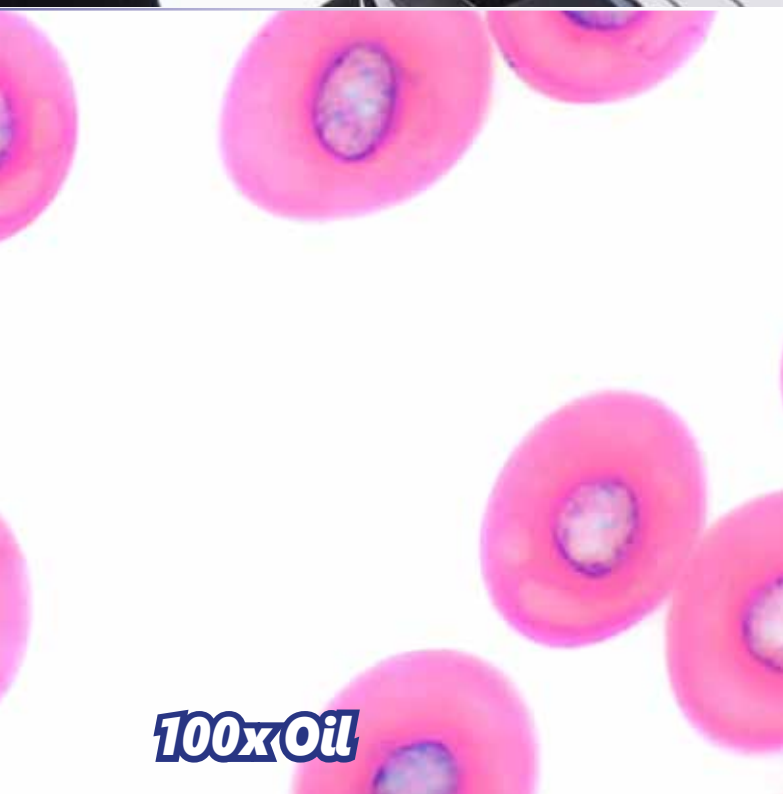

**100x Oil**



**100x Water**

# X-LED<sup>2</sup> – Only Available At OPTIKA

## POWERFUL AND UNIFORM ILLUMINATION

- » Uncomparable light intensity, exclusive lens and collector design
- » Constant pure-white colour temperature at all intensity levels
- » Unmatched colour fidelity and brightness of your specimen

## MONEY & ENERGY SAVING

- » High energy efficiency at a limited cost, only 3 W
- » More efficient brightness than a 30 W halogen lamp
- » LED long lifetime (65.000 hours = 22 years at 8 hours/day usage)

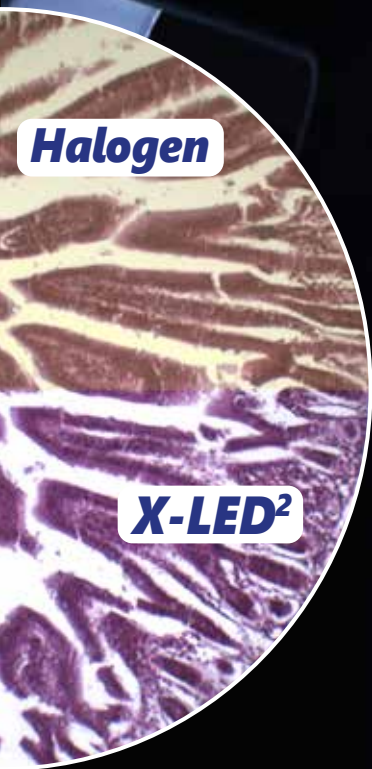
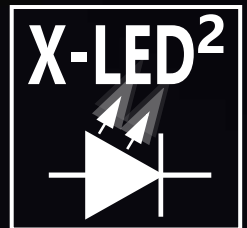

Halogen

X-LED<sup>2</sup>



Multi-plug power supply



## B-190 Series

B-190 is the result of a perfect fusion between years of experience in microscopy and a refined design study. It represents our product philosophy at its best: quality, reliability and innovation, all in one. B-190 Series, the answer of OPTIKA Microscopes to the challenge of the future in the educational field.



### Original, Compact And Robust

The original design of B-190 series is based on robustness, yet keeping the extreme portability of the instrument, with a dedicated handle on the back. The built-in LED illuminator and the patented version with Windows tablet improve the reliability of one of the best-sellers of OPTIKA in the educational field.

### Incorporating The Most Wanted Features In A Student Microscope

Get all the controls and features common to higher level microscopes: mechanical stage, binocular or trinocular head, coaxial focus knob, adjustable condenser, and 1000x maximum magnification (standard). An extremely simple but well equipped solution, in a modern and ergonomic design.

### X-LED<sup>2</sup> Exclusive Lighting Source

A special design of the lens in front of the LED gives a very high light intensity, while ensuring optimal uniformity of illumination on the whole field number. Relevant money & energy saving thanks to the incredibly low energy consumptions allow you to cut the electricity bills by 90%!

The electric consumption (3 W only) proves the high efficiency of this system: incredibly high light intensity combined with low consumption.

### X-LED<sup>2</sup>

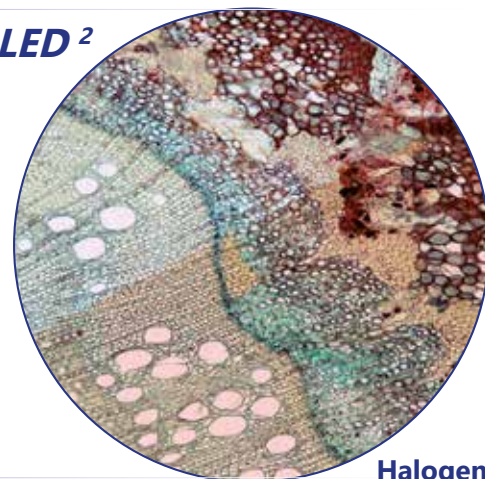

Halogen



# Advanced Biological Microscopes For Students And Teachers

## Optimum And Unparalleled Comfort In Use

The B-190TB offers you a unique, incomparable solution. It includes a built-in camera of 3.1 MP and a Windows tablet with large touch screen, for a responsive and smooth control. Simultaneous camera and power connection ensure long-term operation, with dependable results in one click. It provides a reliable and comfortable solution for open discussion: 360° rotating and tilting tablet, easily detachable, that can be used as a laptop.

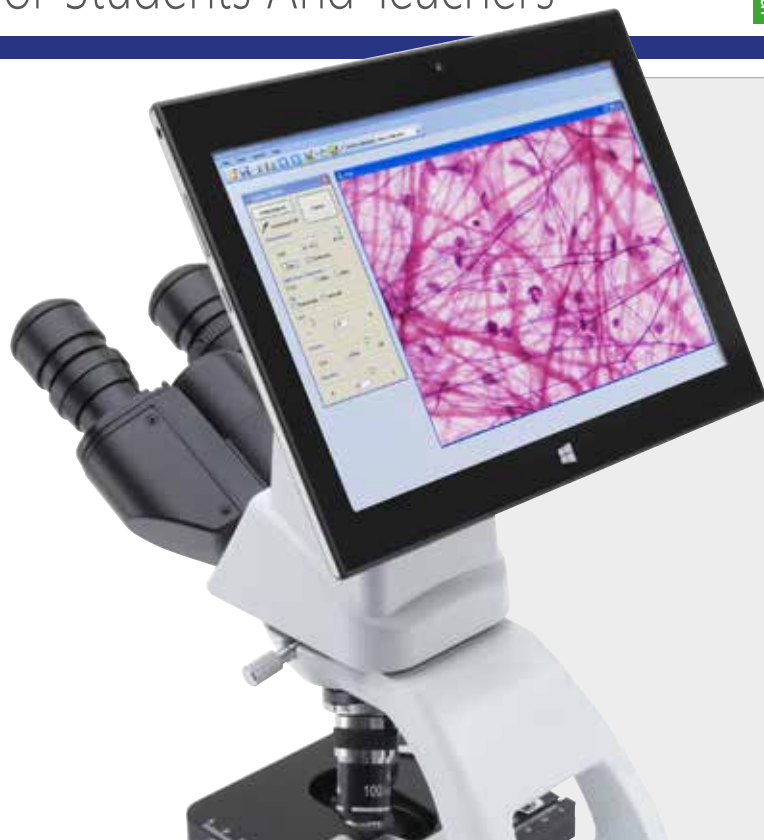

## Get the most out of our accessories

### ANALYZER

#### **M-190 - Polarizing set**

Set for simple polarization analysis. Upgrade your B-190 to a polarizing microscope and look at birefringent samples.



### POLARIZER

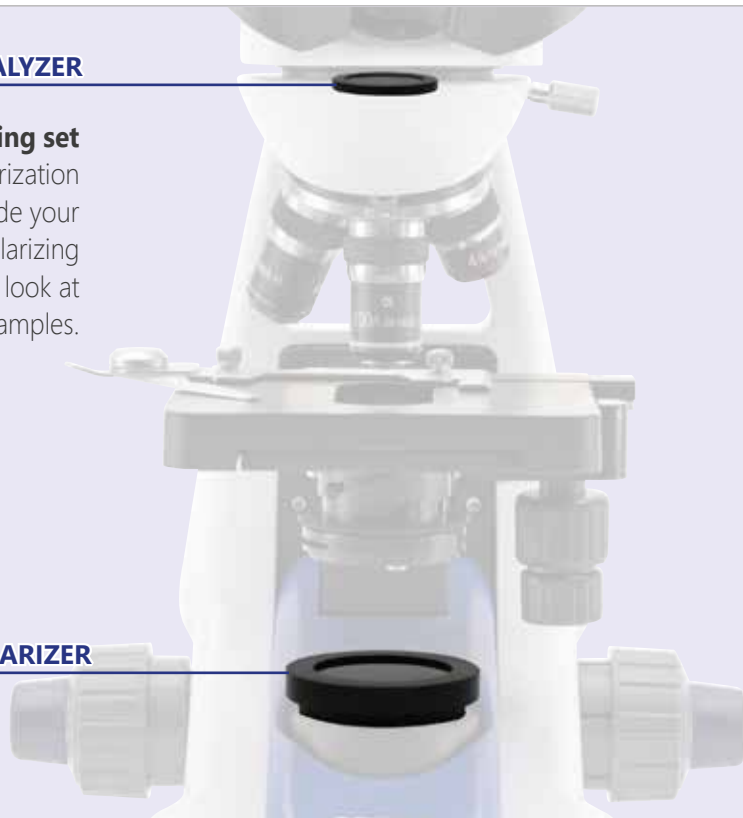

## B-190 Series

### Legend

1. B-190 Series lens containing X-LED<sup>2</sup> illumination system.
2. B-190 Series WF10x/18mm eyepieces for large specimen view and interpupillary adjustment.
3. B-191 pre-centered condenser with achromatic objectives.
4. Frog Blood Smear, with B-192 and 10x objective.
5. Frog Blood Smear, with B-192 and 40x objective.
6. Frog Blood Smear, with B-192 and 100x objective.
7. Frog Blood Smear, with B-192 and 100x objective with water.
8. B-190 Series handle for easy transportation.
9. B-190TB digital microscope with Widows tablet PC.
10. B-190 Series adjustable condenser in height.



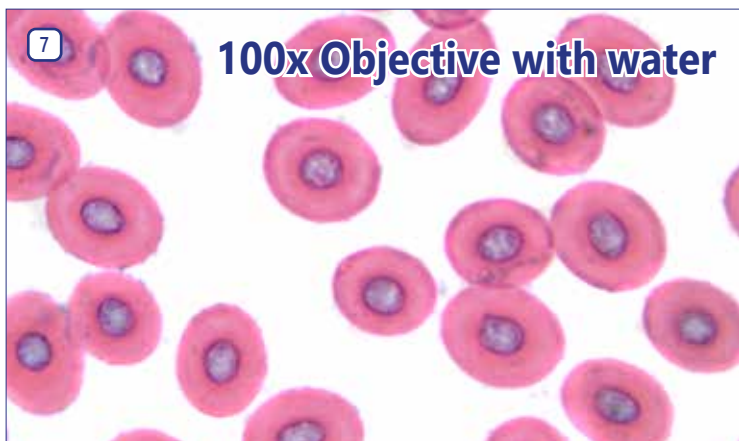
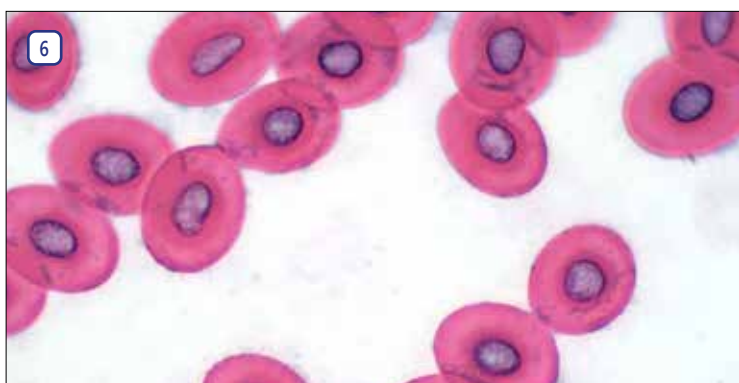
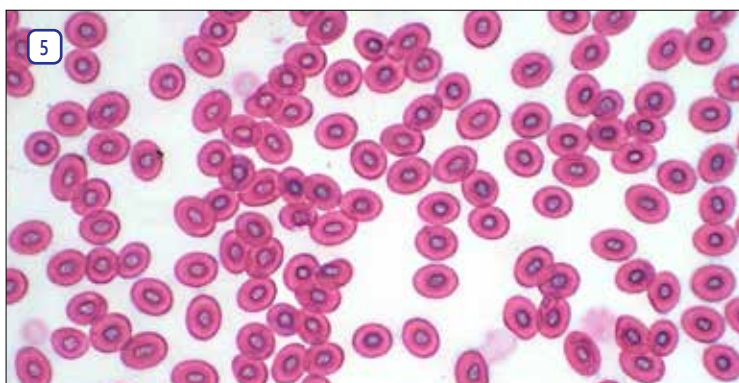
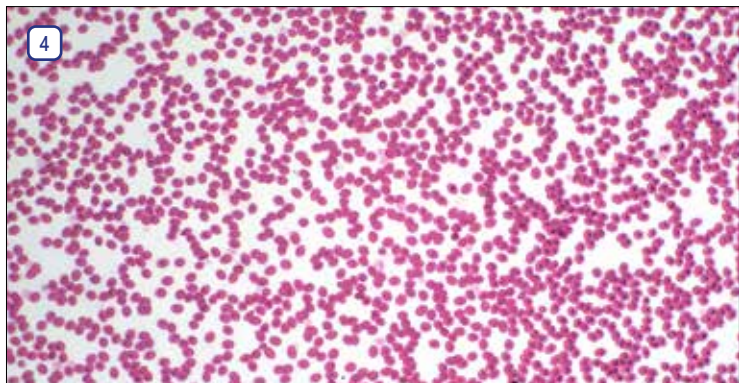

# B-190 Series - Range

Educational

## B-191s



Advanced monocular microscope up to 600x total magnification. The exclusive **X-LED<sup>2</sup>** provides unmatched performance for powerful and uniform illumination.

**Observation mode:** Brightfield.

**Head:** Monocular, 360° rotating and 30° inclined.

**Eyepiece:** WF 10x/18 mm, secured by screw.

**Nosepiece:** Quadruple revolving nosepiece, rotation on ball bearings.

**Objectives:**

- HC - High Contrast Achromatic 4x/0.10 with anti-fungus treatment.
- HC - High Contrast Achromatic 10x/0.25 with anti-fungus treatment.
- HC - High Contrast Achromatic 40x/0.65 with anti-fungus treatment.
- HC - High Contrast Achromatic 60x/0.85 with anti-fungus treatment.

**Specimen stage:** Double layer mechanical sliding stage, 125x115 mm, 70x30 mm X-Y movement range. Vernier scale on the two axes, accuracy: 0.1mm.

**Focusing:** Coaxial coarse and fine focusing mechanism with limit stop to prevent the contact between objective and specimen. Adjustable tension of coarse focusing knob.

**Condenser:** Abbe N.A. 1.25, pre-centered, adjustable height with iris diaphragm.

**Illumination:** X-LED<sup>2</sup> with white 3 W LED and light intensity control. Color temperature: 6,300 K. Multi-plug 100-240Vac/6Vdc external power supply.

## B-191



Advanced monocular microscope up to 1000x total magnification, with oil/water. The exclusive **X-LED<sup>2</sup>** provides unmatched performance for powerful and uniform illumination.

**Observation mode:** Brightfield.

**Head:** Monocular, 360° rotating and 30° inclined.

**Eyepiece:** WF 10x/18 mm, secured by screw.

**Nosepiece:** Quadruple revolving nosepiece, rotation on ball bearings.

**Objectives:**

- HC - High Contrast Achromatic 4x/0.10 with anti-fungus treatment.
- HC - High Contrast Achromatic 10x/0.25 with anti-fungus treatment.
- HC - High Contrast Achromatic 40x/0.65 with anti-fungus treatment.
- HC - High Contrast Achromatic 100x/1.25 (Oil/Water) with anti-fungus treatment.

**Specimen stage:** Double layer mechanical sliding stage, 125x115 mm, 70x30 mm X-Y movement range. Vernier scale on the two axes, accuracy: 0.1mm.

**Focusing:** Coaxial coarse and fine focusing mechanism with limit stop to prevent the contact between objective and specimen. Adjustable tension of coarse focusing knob.

**Condenser:** Abbe N.A. 1.25, pre-centered, adjustable height with iris diaphragm.

**Illumination:** X-LED<sup>2</sup> with white 3 W LED and light intensity control. Color temperature: 6,300 K. Multi-plug 100-240Vac/6Vdc external power supply.



# B-190 Series - Range

1

Educational

## B-192s



Advanced binocular microscope up to 600x total magnification. The exclusive **X-LED<sup>2</sup>** provides unmatched performance for powerful and uniform illumination.

**Observation mode:** Brightfield.

**Head:** Binocular, 360° rotating and 30° inclined. Interpupillary distance from 48 to 75 mm; dioptic adjustment on left eyepiece.

**Eyepieces:** WF 10x/18 mm, secured by screw.

**Nosepiece:** Quadruple revolving nosepiece, rotation on ball bearings.

**Objectives:**

HC - High Contrast Achromatic 4x/0.10 with anti-fungus treatment.  
HC - High Contrast Achromatic 10x/0.25 with anti-fungus treatment.  
HC - High Contrast Achromatic 40x/0.65 with anti-fungus treatment.  
HC - High Contrast Achromatic 60x/0.85 with anti-fungus treatment.

**Specimen stage:** Double layer mechanical sliding stage, 125x115 mm, 70x30 mm X-Y movement range. Vernier scale on the two axes, accuracy: 0.1mm.

**Focusing:** Coaxial coarse and fine focusing mechanism with limit stop to prevent the contact between objective and specimen. Adjustable tension of coarse focusing knob.

**Condenser:** Abbe N.A. 1.25, pre-centered, adjustable height with iris diaphragm.

**Illumination:** X-LED<sup>2</sup> with white 3 W LED and light intensity control. Color temperature: 6,300 K. Multi-plug 100-240Vac/6Vdc external power supply.

## B-192



Advanced binocular microscope up to 1000x total magnification, with oil/water. The exclusive **X-LED<sup>2</sup>** provides unmatched performance for powerful and uniform illumination.

**Observation mode:** Brightfield.

**Head:** Binocular, 360° rotating and 30° inclined. Interpupillary distance from 48 to 75 mm; dioptic adjustment on left eyepiece.

**Eyepieces:** WF 10x/18 mm, secured by screw.

**Nosepiece:** Quadruple revolving nosepiece, rotation on ball bearings.

**Objectives:**

HC - High Contrast Achromatic 4x/0.10 with anti-fungus treatment.  
HC - High Contrast Achromatic 10x/0.25 with anti-fungus treatment.  
HC - High Contrast Achromatic 40x/0.65 with anti-fungus treatment.  
HC - High Contrast Achromatic 100x/1.25 (Oil/Water) with anti-fungus treatment.

**Specimen stage:** Double layer mechanical sliding stage, 125x115 mm, 70x30 mm X-Y movement range. Vernier scale on the two axes, accuracy: 0.1mm.

**Focusing:** Coaxial coarse and fine focusing mechanism with limit stop to prevent the contact between objective and specimen. Adjustable tension of coarse focusing knob.

**Condenser:** Abbe N.A. 1.25, pre-centered, adjustable height with iris diaphragm.

**Illumination:** X-LED<sup>2</sup> with white 3 W LED and light intensity control. Color temperature: 6,300 K. Multi-plug 100-240Vac/6Vdc external power supply.

# B-190 Series - Range

## B-193



Advanced trinocular microscope up to 1000x total magnification, with oil/water, mechanical stage and exclusive **X-LED<sup>2</sup>** for unmatched performance for powerful and uniform illumination. All the OPTIKA cameras can be easily mounted and used straight away.

**Observation mode:** Brightfield.

**Head:** Trinocular, 360° rotating and 30° inclined. Interpupillary distance from 48 to 75 mm; dioptic adjustment on left eyepiece.

**Eyepieces:** WF 10x/18 mm, secured by screw.

**Nosepiece:** Quadruple revolving nosepiece, rotation on ball bearings.

**Objectives:**

- HC - High Contrast Achromatic 4x/0.10 with anti-fungus treatment.
- HC - High Contrast Achromatic 10x/0.25 with anti-fungus treatment.
- HC - High Contrast Achromatic 40x/0.65 with anti-fungus treatment.
- HC - High Contrast Achromatic 100x/1.25 (Oil/Water) with anti-fungus treatment.

**Specimen stage:** Double layer mechanical sliding stage, 125x115 mm, 70x30 mm X-Y movement range. Vernier scale on the two axes, accuracy: 0.1mm.

**Focusing:** Coaxial coarse and fine focusing mechanism with limit stop to prevent the contact between objective and specimen. Adjustable tension of coarse focusing knob.

**Condenser:** Abbe N.A. 1.25, pre-centered, adjustable height with iris diaphragm.

**Illumination:** X-LED<sup>2</sup> with white 3 W LED and light intensity control. Color temperature: 6,300 K. Multi-plug 100-240Vac/6Vdc external power supply.

## B-190TB



**PATENTED**

3.1 MP Built-in camera and 10.8" Windows tablet PC up to 1000x total magnification, mechanical stage and exclusive **X-LED<sup>2</sup>** for unmatched performance for powerful and uniform illumination.

**Observation mode:** Brightfield.

**Head:** Binocular, 360° rotating and 30° inclined. Interpupillary distance from 48 to 75 mm; dioptic adjustment on left eyepiece. Built-in 3.1 MP camera.

**Eyepieces:** WF 10x/18 mm, secured by screw.

**Nosepiece:** Quadruple revolving nosepiece, rotation on ball bearings.

**Objectives:**

- HC - High Contrast Achromatic 4x/0.10 with anti-fungus treatment.
- HC - High Contrast Achromatic 10x/0.25 with anti-fungus treatment.
- HC - High Contrast Achromatic 40x/0.65 with anti-fungus treatment.
- HC - High Contrast Achromatic 100x/1.25 (Oil/Water) with anti-fungus treatment.

**Specimen stage:** Double layer mechanical sliding stage, 125x115 mm, 70x30 mm X-Y movement range. Vernier scale on the two axes, accuracy: 0.1mm.

**Focusing:** Coaxial coarse (adjustable tension) and fine focusing mechanism with limit stop to prevent the contact between objective and specimen.

**Condenser:** Abbe N.A. 1.25, pre-centered, adjustable height with iris diaphragm.

**Illumination:** X-LED<sup>2</sup> with white 3 W LED and light intensity control. Color temperature: 6,300 K. Multi-plug 100-240Vac/6Vdc external power supply. Color temperature: 6,300 K.

# B-190TB - Digital Microscope with Camera & Tablet

The latest OPTIKA digital microscopes with Windows tablet PC open new microscopy horizons, combining high-end optics with innovative digital technology for microscopic imaging. B-190TB includes a 3.1 MP camera with a 10.8" Windows tablet. View, capture, analyze and share your images with simplicity and reliability.

## Intuitive, Yet Powerful Software

Simple and user-friendly, ideal for students and experienced users.

**PATENTED**



### Unique Features

- > Simultaneous camera & power connection
- > Equipped with the latest **Windows OS & Intel** processor
- > Easily detachable, can be used as a laptop (keyboard included)

## 360° Rotating & Tilting



## Detachable



# B-190TB - Digital microscope with camera & tablet

Tilting

## TABLET TECHNICAL SPECIFICATIONS

Model	Tablet 10.8"
Operating System	Windows 10 32-bit
Language	Multilanguages already installed
Image capturing software	OPTIKA Vision lite
CPU	Intel® Atom™ Z3735F, Quad core
CPU speed	1.44 GHz
Graphics Card	Intel® HD Graphics 3D Accelerator
Memory	Ram 2,048 GB DDR3L
LCD display	<b>LED 10.1" IPS Multi Touch Screen</b>
LCD resolution	1920 x 1280, 16/10 (WXGA)
Storage	HDD 64GB
Network	Wireless, Bluetooth 4.0
Input/output ports	Micro USB-B - USB - Microphone - MicroSD card reader - Mini HDMI - Head-phone
Control Buttons	Auto rotate off, volume control
Battery Technology	Lithium-ion battery, 2x cell
Battery capacity	8400 mAh
Max load	15 W
Dimensions	Thickness 10,5 mm, Height 17,4 cm, Width 25,7 cm
Weight	720 g
Cables included	USB-B to USB-A / OTG cable (Micro USB-B to USB-A)
Also included	Instruction manual, Keyboard with touchpad, touch pen.

## CAMERA TECHNICAL SPECIFICATIONS

Digital camera resolution	3.14 MPixel
Signal output	USB 2.0
Sensor Size	1/2.5"
Sensor technology	CMOS
Image format	4\3
Full Image size	2048 x 1536
Pixel size	2.2 x 2.2 micron
Frame rate full resolution	5 frames\sec
Frame rate other resolutions	8 FPS (1280x1024) - 30FPS (640x480)
Automatic White Balance	Auto - Man
Automatic Gain Control	Auto - Man
Automatic Back light control	Auto - Man
Exposure control	Auto - Man

# B-190 Series - Optical performance

Eyepiece		10x (M-002.1)			16x (M-003)	
Field number (mm)		18			12	
Objective	N.A.	W.D (mm)	Total magnification	Field of View (mm)	Total magnification	Field of View (mm)
4x	0.1	18	40x	4.5	64x	3
10x	0.25	7	100x	1.8	160x	1.2
20x	0.4	2	200x	0.9	320x	0.6
40x	0.65	0.53	400x	0.45	640x	0.3
60x	0.85	0.45	600x	0.3	960x	0.2
100x	1.25 (oil/water)	0.13	1000x	0.18	1600x	0.12



**HC**

**OPTIKA HC** objectives ensure a versatile and reasonably priced entry-level lenses for brightfield, darkfield and simple polarization applications. They are specifically designed to achieve optimal contrast and thus maximize yield on an instrument intended for education on F.N. 18.

## B-190 Series - Zoom comparison

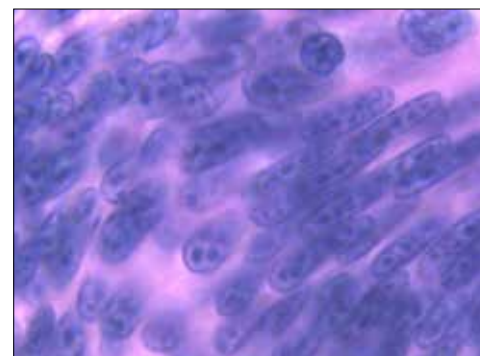
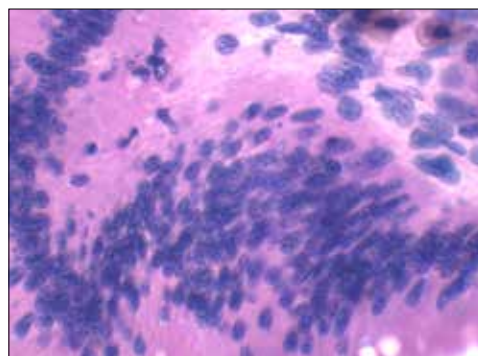
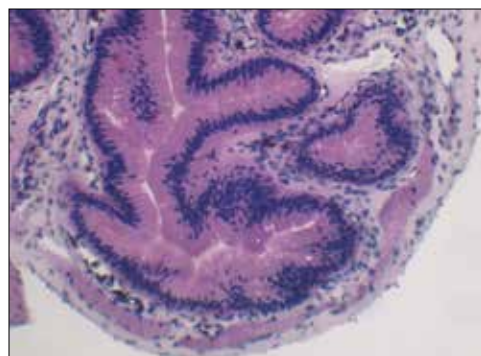

Frog small intestine - B-193 - 10x HC objective

Frog small intestine - B-193 - 40x HC objective

Frog small intestine - B-193 - 100x Oil HC objective

## B-190 Series - Comparison chart

Model	Head	Eyepiece(s)	Nosepiece	Objectives	Stage	Focusing	Condenser	Illuminator
<b>B-191s</b>	Monocular, 360° rotating, 30° inclined	Wide Field 10x/18mm	Quadruple, reversed	HC Achromatic 4x, 10x, 40x, 60x	Double layer, 125x115 mm with 70x30mm X-Y moving range	Coaxial coarse and fine focusing	N.A. 1.25 Abbe type with adjustable height and iris diaphragm	3 W X-LED <sup>2</sup> , brightness control
<b>B-191</b>	Monocular, 360° rotating, 30° inclined	Wide Field 10x/18mm	Quadruple, reversed	HC Achromatic 4x, 10x, 40x, 100x	Double layer, 125x115 mm with 70x30mm X-Y moving range	Coaxial coarse and fine focusing	N.A. 1.25 Abbe type with adjustable height and iris diaphragm	3 W X-LED <sup>2</sup> , brightness control
<b>B-192s</b>	Binocular, 360° rotating, 30° inclined	Wide Field 10x/18mm	Quadruple, reversed	HC Achromatic 4x, 10x, 40x, 60x	Double layer, 125x115 mm with 70x30mm X-Y moving range	Coaxial coarse and fine focusing	N.A. 1.25 Abbe type with adjustable height and iris diaphragm	3 W X-LED <sup>2</sup> , brightness control
<b>B-192</b>	Binocular, 360° rotating, 30° inclined	Wide Field 10x/18mm	Quadruple, reversed	HC Achromatic 4x, 10x, 40x, 100x	Double layer, 125x115 mm with 70x30mm X-Y moving range	Coaxial coarse and fine focusing	N.A. 1.25 Abbe type with adjustable height and iris diaphragm	3 W X-LED <sup>2</sup> , brightness control
<b>B-193</b>	Trinocular, 360° rotating, 30° inclined	Wide Field 10x/18mm	Quadruple, reversed	HC Achromatic 4x, 10x, 40x, 100x	Double layer, 125x115 mm with 70x30mm X-Y moving range	Coaxial coarse and fine focusing	N.A. 1.25 Abbe type with adjustable height and iris diaphragm	3 W X-LED <sup>2</sup> , brightness control
<b>B-190TB</b>	Binocular, digital 360° rotating, 30° inclined	Wide Field 10x/18mm	Quadruple, reversed	HC Achromatic 4x, 10x, 40x, 100x	Double layer, 125x115 mm with 70x30mm X-Y moving range	Coaxial coarse and fine focusing	N.A. 1.25 Abbe type with adjustable height and iris diaphragm	3 W X-LED <sup>2</sup> , brightness control

# B-190 Series - Accessories

## Eyecups & Eyepieces

M-001	Huygens 5x eyepiece
M-002.1	WF10x/18 eyepiece, high eyepoint
M-004	WF10x/18 micrometric eyepiece, high eyepoint
M-008	WF10x/18 eyepiece, high eyepoint, with pointer
M-003	WF16x/12 eyepiece
M-162	WF20x/10 eyepiece

## Objectives & Additional Lenses

M-137	HC (high contrast) objective 4x/0.10
M-138	HC (high contrast) objective 10x/0.25
M-139	HC (high contrast) objective 20x/0.40
M-141	HC (high contrast) objective 40x/0.65
M-142	HC (high contrast) objective 60x/0.85
M-143	HC (high contrast) objective 100x/1.25 (oil)

## Condensers & Filters

M-174	Polarising set (filters only)
M-974	Blue filter, 32 mm diameter
M-976	Green filter, 32 mm diameter
M-978	Yellow filter, 32 mm diameter
M-988	Frosted glass filter, 32 mm diameter

## Camera Adapters

M-115	0.35x C-Mount projection lens
M-114	0.5x C-Mount projection lens
M-118	0.75x C-Mount projection lens
M-173	C-Mount projection lens for APS-C/full frame reflex cameras (trino)

## Miscellaneous

15104	Cleaning kit
15008	Immersion oil, 10ml
15009	Immersion oil, 100ml
DC-002	Plastic dust cover, medium, 490(l)x490(h) mm (except for B-190TB)
DC-003	TNT dust cover, medium, 600(l)x550(h) mm (only for B-190TB)
M-005	Micrometric slide, 26x76mm, with 2 scales (1mm/100 & 10mm/100)
M-069	Solar charger
M-971	Plane-concave mirror, with base
VP-190	IQ/OQ/PQ manual for B-190 series
VP-TB	IQ/OQ/PQ manual for TB series

## M-069 - Solar charger

Included battery: rechargeable – Lithium-Poly. Capacity: 2600 mAh. Output voltage: 5,5Vdc. - Dimensions: 120x73x10 mm. Autonomy: over 6 hours at medium intensity (X-LED<sup>3</sup>). Charging modes: with solar panel (12h), with external USB power supply (not included) or from PC USB port (5h).



B-192 Powered by solar battery pack (M-069)

## 15104 - Cleaning kit

It cleans glass quickly and effectively, without leaving residue or odor. Ideal for precision lens or prism cleaning.



### How to connect the cameras to our microscopes.

Please refer to the Adapter reference list on Digital section.

v 1.4.0 - OPTIKA reserves the right to make corrections, modifications, enhancements, improvements and other changes to its products at any time without notice.

## Headquarters and Manufacturing Facilities

**OPTIKA® S.r.l.** Via Rigla, 30 - 24010 Ponteranica (BG) - ITALY - Tel.: +39 035.571.392 - info@optikamicroscopes.com

## Optika Sales branches

**OPTIKA® Spain** spain@optikamicroscopes.com  
**OPTIKA® China** china@optikamicroscopes.com  
**OPTIKA® India** india@optikamicroscopes.com

**OPTIKA® USA** usa@optikamicroscopes.com  
**OPTIKA® Central America** america@optikamicroscopes.com

## MS/SFX Series



**Entry-Level Monoscopes & Stereomicroscopes For Students**

# Addressed For Simplicity & The Youngest Users

## DESIGNED FOR NOVICE USERS

- » Reliable microscopes for education
- » Particularly recommended for primary and secondary schools
- » Ideal for discovering, biology, material science and amateur field

## EDUCATIONAL STEREO-MICROSCOPES

- » Wide range of solutions and magnifications
- » Up to, 20 mm field number
- » Equipped with high performance LED illumination



# Rechargeable Batteries On Field Use

## CORDLESS, EASILY TRANSPORTABLE

- » Stable, yet compact and light weight
- » Dedicated handle for enhanced comfort
- » Fast recharging time

## NO NEED FOR POWER CONNECTION

- » Powered by rechargeable batteries (SFX models)
- » Long-lasting, up to 8 hours from a single charge
- » Always ready to work, everywhere





# Attention To Detail

## HANDY, YET EXTREMELY STABLE

- » Compact, practical and intuitive to use
- » Optics ensuring good quality images
- » Get impressive images and live videos with eyepiece cameras

## EASY TO TAKE CARE OF

- » Sturdy, durable for extended lifetime
- » No maintenance required
- » Dust cover (included) protects from environmental contaminants



# A New Frontier In Illumination Adjustment

## HIGH COMFORT TOUCH CONTROL

- » Light intensity settable via a simple click
- » 5 pre-set intensity levels
- » Separated control for transmitted and incident light

## FULFILL ALL THE LEARNING CHALLENGES

- » Turnable objective with up to 3 magnifications
- » Precision stand for accurate focusing
- » 3 MP integrated digital camera (on SFX-91D)



## MS/SFX Series

OPTIKA MS/SFX Series includes a wide selection of mono/stereomicroscopes designed to satisfy every need in both teaching and amateur fields.

Slim and easy to carry solutions, it is equipped with all you need to start learning to use a scientific instrument: 20 mm field of view, up to 40x maximum magnification, several options concerning illumination (including rechargeable batteries), objectives, and stands.

### Greenough Optical System

The V-shape optical path of Greenough allows us to design a very compact and a slim unit, highly versatile and appreciated for the 3D viewing. Vertical heads or 45° inclined to grant comfortable posture to the user even after several hours of operation.

### Incorporating the Most Wanted Features in a Student Microscope

Stereomicroscopes are the best way to enter the world of magnified 3D vision of objects such as insects, rocks, plants, and many other samples. The binocular head ensures a comfortable view. Optional eyepieces and objectives allow to increase even further the maximum magnification.



### LED with Rechargeable Batteries - Optimized Illumination

Money & energy saving thanks to LED long lifetime (65.000 hours, 22 years in case of 8 hours/day) which is more than 20 times compared to a standard halogen bulb. **All the SFX Series** has internal rechargeable batteries for up to 8 hours (at medium intensity) of outdoor use.

### 360° Rotating Heads

**SFX-51** and **SFX-52** have a 360° rotating head, for the most comfortable teaching experience. The head, through rotation, can be shared among different users or adjusted to the user position.

### LWD - Long Working Distance

**ST-50Led** has a special objective with long working distance that allows you to inspect bulky samples, thanks also to its overhanging arm stand and LED flexible incident light.



# Entry-Level Monoscopes & Stereomicroscopes For Students



## Legend

1. Transport handle, SFX-91.
2. Fly eyes, with SFX-91D and 4x objective.
3. Mineral rock, with ST-30FX and 4x objective.
4. Mineral rock, with SFX-51 and 4x objective.
5. Transmitted and incident light setting, in recharging mode, SFX-52.
6. Coin, with SFX-91 and 4x objective.

# MS/SFX Series - Range

## MS-1



Portable microscope but also a multifunctional testing instrument for applications where magnifying lenses are not good enough. It has to be used directly on the specimen to be inspected.  
Total magnification: 100x.

**Observation mode:** Brightfield.

**Eyepiece:** WF 10x/15.5 mm, micrometric with cross.

**Objective:** Achromatic 10x with anti-fungus treatment.

**Focusing:** Rack and pinion controlled knobs placed on both sides of the stand.

**Illumination:** 0.3 W Led penlight. Powered by AAA batteries (not included).

## MS-2



Entry-level monoscope with fixed objective (2x) that can be combined to external illuminators, in case some light is required.

**Observation mode:** Brightfield.

**Head:** Monocular head, 45° inclined, 360° rotating.

**Objective:** Achromatic 2x with anti-fungus treatment.

**Stand:** Pillar stand with focus.

**Focusing:** Rack and pinion controlled by a pair of knobs placed on both sides of the stand.

**Illumination:** Without illumination.

## STX



Simple binocular stereomicroscope equipped with fixed objective (2x) and LED incident illumination, combining bright and uniform illumination with low consumption. Powered by AA batteries (not included).

**Observation mode:** Brightfield.

**Head:** Binocular vertical head.

**Interpupillary distance:** Adjustable.

**Eyepieces:** WF 10x/16 mm.

**Objective:** Achromatic 2x with anti-fungus treatment.

**Stand:** Fixed stand with focus.

**Focusing:** Rack and pinion controlled by a pair of knobs placed on both sides of the stand.

**Illumination:** Incident: 0.1W LED, powered by 2 AA batteries (not included).

## ST-30FX



Classic binocular stereomicroscope equipped with turnable objective (2x-4x), pillar stand, and incredibly bright and uniform LED illumination (transmitted and incident).

**Observation mode:** Brightfield.

**Head:** Binocular head, 45° inclined.

**Interpupillary distance:** Adjustable.

**Dioptric adjustment:** On the left eyepiece.

**Eyepieces:** WF 10x/20 mm, secured by screw, with rubber cups.

**Objective:** Achromatic 2x-4x with anti-fungus treatment.

**Stand:** Pillar stand with focus.

**Focusing:** Rack and pinion controlled by a pair of knobs placed on both sides of the stand.

**Illumination:** Incident: 1 W LED, transmitted: 1 W LED.

Color temperature: 6,300 K.

100-240Vac/12Vdc external power supply.

**Models available:**

**ST-30FX-EU** Binocular stereomicroscope, EU

**ST-30FX-UK** Binocular stereomicroscope, UK adapter

**ST-30FX-US** Binocular stereomicroscope, US adapter

## SFX-31



Binocular stereomicroscope equipped with turnable objective (2x-4x), pillar stand, and incredibly bright and uniform LED illumination (transmitted and incident) with rechargeable batteries.

**Observation mode:** Brightfield.

**Head:** Binocular heads, 45° inclined.

**Interpupillary distance:** Adjustable.

**Dioptric adjustment:** On both eyepieces.

**Eyepieces:** WF 10x/20 mm, secured by screw.

**Objective:** Achromatic 2x-4x with anti-fungus treatment.

**Stand:** Pillar stand with focus.

**Focusing:** Rack and pinion controlled by a pair of knobs placed on both sides of the stand.

**Illumination:** Incident: 1 W LED, transmitted: 1 W LED. Dial brightness

control. Rechargeable batteries.

Color temperature: 6,300 K.

# MS/SFX Series - Range

## SFX-32

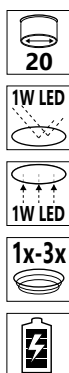

Binocular stereomicroscope equipped with turnable objective (1x-3x), pillar stand, and incredibly bright and uniform led illumination (transmitted and incident) with rechargeable batteries.

**Observation mode:** Brightfield.

**Head:** Binocular heads, 45° inclined.

**Interpupillary distance:** Adjustable.

**Dioptric adjustment:** On both eyepieces.

**Eyepieces:** WF 10x/20 mm, secured by screw.

**Objective:** Achromatic 1x-3x with anti-fungus treatment.

**Stand:** Pillar stand with focus.

**Focusing:** Rack and pinion controlled by a pair of knobs placed on both sides of the stand.

**Illumination:** Incident: 1 W LED, transmitted: 1 W LED. Dial brightness control. With rechargeable batteries.  
Color temperature: 6,300 K.

## SFX-33



Binocular stereomicroscope equipped with turnable objective (2x-4x), fixed arm with handle, and incredibly bright and uniform led illumination (transmitted and incident), settable through the exclusive touch control. Powered by rechargeable batteries.

**Observation mode:** Brightfield.

**Heads:** Binocular head, 45° inclined.

**Interpupillary distance:** Adjustable.

**Dioptric adjustment:** On both eyepieces.

**Eyepieces:** WF 10x/20 mm, secured by screw.

**Objective:** Achromatic 2x-4x with anti-fungus treatment.

**Stand:** Fixed stand with focus and handle.

**Focusing:** Rack and pinion controlled by a pair of knobs placed on both sides of the stand.

**Illumination:** Incident: 1 W LED, transmitted: 1 W LED. Touch brightness control. With rechargeable batteries.  
Color temperature: 6,300 K.  
Multi-plug 100-240Vac/5Vdc external power supply.

## SFX-34

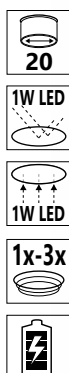

Binocular stereomicroscope equipped with turnable objective (1x-3x), fixed arm with handle, and incredibly bright and uniform led illumination (transmitted and incident), settable through the exclusive touch control. Powered by rechargeable batteries.

**Observation mode:** Brightfield.

**Head:** Binocular head, 45° inclined.

**Interpupillary distance:** Adjustable.

**Dioptric adjustment:** On both eyepieces.

**Eyepieces:** WF 10x/20 mm, secured by screw.

**Objective:** Achromatic 1x-3x with anti-fungus treatment.

**Stand:** Fixed stand with focus and handle.

**Focusing:** Rack and pinion controlled by a pair of knobs placed on both sides of the stand.

**Illumination:** Incident: 1W LED, transmitted: 1W LED. Touch brightness control. With rechargeable batteries.  
Color temperature: 6,300 K.

## SFX-51

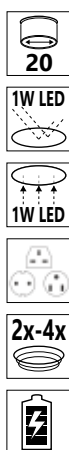

Binocular stereomicroscope equipped with turnable objective (2x-4x), 360° rotating head, fixed arm with handle, and incredibly bright and led uniform illumination (transmitted and incident), settable through the exclusive touch control. Powered by rechargeable batteries.

**Observation mode:** Brightfield.

**Head:** Binocular head, 45° inclined, 360° rotating.

**Interpupillary distance:** Adjustable.

**Dioptric adjustment:** On both eyepieces.

**Eyepieces:** WF 10x/20 mm, secured by screw.

**Objective:** Achromatic 2x-4x with anti-fungus treatment.

**Stand:** Fixed stand with focus and handle.

**Focusing:** Rack and pinion controlled by a pair of knobs placed on both sides of the stand.

**Illumination:** Incident: 1W LED, transmitted: 1W LED. Touch brightness control. With rechargeable batteries.  
Color temperature: 6,300 K.  
Multi-plug 100-240Vac/5Vdc external power supply.

## SFX-52



Binocular stereomicroscope equipped with turnable objective (1x-3x), 360° rotating head, fixed arm with handle, and incredibly bright and uniform led illumination (transmitted and incident), settable through the exclusive touch control. Powered by rechargeable batteries.

**Observation mode:** Brightfield.

**Head:** Binocular head, 45° inclined, 360° rotating.

**Interpupillary distance:** Adjustable.

**Dioptric adjustment:** On both eyepieces.

**Eyepieces:** WF 10x/20 mm, secured by screw.

**Objective:** Achromatic 1x-3x with anti-fungus treatment.

**Stand:** Fixed stand with focus and handle.

**Focusing:** Rack and pinion controlled by a pair of knobs placed on both sides of the stand.

**Illumination:** Incident: 1W LED, transmitted: 1W LED. Touch brightness control. With rechargeable batteries.  
Color temperature: 6,300 K.

## SFX-91



Binocular stereomicroscope equipped with turnable objective with 3 magnifications (1x-2x-4x), precision fixed arm with handle, and incredibly bright and uniform led illumination (transmitted and incident), settable through the exclusive touch control. Powered by rechargeable batteries.

**Observation mode:** Brightfield.

**Head:** Binocular head, 45° inclined.

**Interpupillary distance:** Adjustable.

**Dioptric adjustment:** On both eyepieces.

**Eyepieces:** WF 10x/20 mm, secured by screw.

**Objective:** Achromatic 1x-2x-4x with anti-fungus treatment.

**Stand:** High-grade fixed stand with focus and handle.

**Focusing:** Rack and pinion controlled by a pair of knobs placed on both sides of the stand.

**Illumination:** Incident: 1W LED, transmitted: 1W LED.  
Touch brightness control. With rechargeable batteries.  
Color temperature: 6,300 K.



# MS/SFX Series - Range

## SFX-91D



Digital binocular stereomicroscope equipped with with 3 magnifications turnable objective (1x-2x-4x), precision fixed arm with handle, and incredibly bright and uniform led illumination (transmitted and incident), settable through the exclusive touch control. Powered by rechargeable batteries.

**Observation mode:** Brightfield.

**Head:** Binocular head, 45° inclined, with built-in 3Mp USB digital camera.

**Interpupillary distance:** Adjustable.

**Dioptric adjustment:** On both eyepieces.

**Eyepieces:** WF 10x/20 mm, secured by screw.

**Objective:** Achromatic 1x-2x-4x with anti-fungus treatment.

**Stand:** High-grade fixed stand with focus and handle.

**Focusing:** Rack and pinion controlled by a pair of knobs placed on both sides of the stand.

**Illumination:** Incident: 1W LED, transmitted: 1W LED. Touch brightness control. With rechargeable batteries.

Color temperature: 6,300 K.

Multi-plug 100-240Vac/5Vdc external power supply.

## ST-50Led

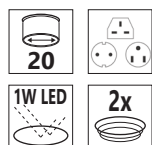

Binocular stereomicroscope equipped with fixed objective (2x), swiveling LED incident illumination on an overhanging, flexible arm. Ideal for long working distance (119 mm with standard 2x objective, 165 mm with ST-025, 124 mm with ST-026).

**Observation mode:** Brightfield.

**Heads:** Binocular head, 45° inclined.

**Interpupillary distance:** Adjustable.

**Dioptric adjustment:** On the left eyepiece.

**Eyepieces:** WF 10x/20 mm, secured by screw.

**Objective:** Achromatic 2x with anti-fungus treatment.

**Stand:** Overhanging stand with focus.

**Focusing:** Rack and pinion controlled by a pair of knobs placed on both sides of the stand.

**Illumination:** Incident: 1W LED on flexible arm.

Color temperature: 6,300 K.

Multi-plug 100-240Vac/6Vdc external power supply.

# MS/SFX Series - Comparison Chart

Model	Head	Eyepieces	Objective	Working Distance	Stand	Illumination
<b>MS-1</b>	-	WF 10x/15.5	10x fixed	6 mm	Fixed with focus	0.3 W LED penlight. Powered by AAA batteries (not included)
<b>MS-2</b>	Monocular, 45° inclined, 360° rotating	WF 10x/16	2x fixed	57 mm	Pillar with focus	-
<b>STX</b>	Binocular, vertical, fixed	WF 10x/16	2x fixed	67 mm	Fixed with focus	Incident: 0.1 W LED Powered by 2 AA batteries (not included)
<b>ST-30FX</b>	Binocular, 45° inclined, fixed	WF 10x/20	2x – 4x selectable	57 mm	Pillar with focus	Incident: 1 W LED Transmitted: 1 W LED
<b>SFX-31</b>	Binocular, 45° inclined, fixed	WF 10x/20	2x – 4x selectable	57 mm	Pillar with focus	Incident: 1 W LED Transmitted: 1 W LED Dial brightness control Rechargeable batteries
<b>SFX-32</b>	Binocular, 45° inclined, fixed	WF 10x/20	1x – 3x selectable	57 mm	Pillar with focus	Incident: 1 W LED Transmitted: 1 W LED Dial brightness control Rechargeable batteries
<b>SFX-33</b>	Binocular, 45° inclined, fixed	WF 10x/20	2x – 4x selectable	57 mm	Fixed with focus and handle	Incident: 1 W LED Transmitted: 1 W LED Touch brightness control Rechargeable batteries
<b>SFX-34</b>	Binocular, 45° inclined, fixed	WF 10x/20	1x – 3x selectable	57 mm	Fixed with focus and handle	Incident: 1 W LED Transmitted: 1 W LED Touch brightness control Rechargeable batteries
<b>SFX-51</b>	Binocular, 45° inclined, 360° rotating	WF 10x/20	2x – 4x selectable	76 mm	Fixed with focus and handle	Incident: 1 W LED Transmitted: 1 W LED Touch brightness control Rechargeable batteries
<b>SFX-52</b>	Binocular, 45° inclined, 360° rotating	WF 10x/20	1x – 3x selectable	76 mm	Fixed with focus and handle	Incident: 1 W LED Transmitted: 1 W LED Touch brightness control Rechargeable batteries
<b>SFX-91</b>	Binocular, 45° inclined, fixed	WF 10x/20	1x – 2x – 4x selectable	60 mm	High-grade fixed with focus and handle	Incident: 1 W LED Transmitted: 1 W LED Touch brightness control Rechargeable batteries
<b>SFX-91D</b>	Binocular, 45° inclined, 3 MP integrated camera	WF 10x/20	1x – 2x – 4x selectable	60 mm	High-grade fixed with focus and handle	Incident: 1 W LED Transmitted: 1 W LED Touch brightness control Rechargeable batteries
<b>ST-50Led</b>	Binocular, 45° inclined, fixed	WF 10x/20	2x fixed	119 mm	Overhanging with focus	Incident: 1 W LED on flexible arm





# MS/SFX Series - Accessories

## ACCESSORIES FOR STX, MS-1 AND MS-2

### Stage

ST-015 Glass object-plate, 60mm diameter (only for MS-2)

### Miscellaneous

DC-001 Plastic dust cover, small, 340(l)x400(h) mm

M-899 Pen illuminator (only for MS-1)

15104 Cleaning kit

## ACCESSORIES FOR SFX SERIES & ST-50Led

### Eyepieces & Eyepieces

ST-001 WF5x/22 eyepieces (pair), 30.5mm diameter (except for ST-50Led)

ST-002 WF10x/20 eyepieces (pair)

ST-003 WF15x/15 eyepieces (pair)

ST-004 WF20x/13 eyepieces (pair)

ST-005 WF10x/20 micrometric eyepiece

ST-001.1 WF5x/22 eyepieces (pair), 30mm diameter (only for ST-50Led)

### Objectives & Additional Lenses

ST-025 1x objective (only for ST-50Led)

ST-026 3.5x objective (only for ST-50Led)

### Stage

ST-014 Glass object-plate, 95mm diameter (only for ST-30FX)

ST-015 Glass object-plate, 60mm diameter (except for ST-30FX & ST-50Led)

ST-011 White/black object-plate, 60mm diameter (except for ST-30FX & ST-50Led)

ST-012 White/black object-plate, 95mm diameter (only for ST-30FX)

### Camera Adapters

M-114 0.5x C-Mount projection lens

M-115 0.35x C-Mount projection lens

M-118 0.75x C-Mount projection lens

### Miscellaneous

M-113.1 Ring adapter, 30mm (for monocular and binocular microscopes) (except ST-50Led)

M-113.2 Ring adapter, 30.5mm (for monocular and binocular microscopes) (only for ST-50Led)

DC-001 Plastic dust cover, small, 340(l)x400(h) mm (except for ST-50Led)

DC-002 Plastic dust cover, medium, 490(l)x490(h) mm (only for ST-50Led)

M-005 Micrometric slide, 26x76mm, with 2 scales (1mm/100 & 10mm/100)

15104 Cleaning kit

ST-041 Sample clip (only for ST-30FX)

### 15104 - Cleaning kit

It cleans glass quickly and effectively, without leaving residue or odor. Ideal for precision lens or prism cleaning.



### How to connect the cameras to our microscopes.

Please refer to the Adapter reference list on Digital section.

v 1.4.0 - OPTIKA reserves the right to make corrections, modifications, enhancements, improvements and other changes to its products at any time without notice.

## Headquarters and Manufacturing Facilities

**OPTIKA® S.r.l.** Via Rigla, 30 - 24010 Ponteranica (BG) - ITALY - Tel.: +39 035.571.392 - info@optikamicroscopes.com

## Optika Sales branches

**OPTIKA® Spain** spain@optikamicroscopes.com

**OPTIKA® China** china@optikamicroscopes.com

**OPTIKA® India** india@optikamicroscopes.com

**OPTIKA® USA**

**OPTIKA® Central America**

usa@optikamicroscopes.com

camerica@optikamicroscopes.com

## SLX Series



**Stereomicroscopes For Higher Education & Laboratory**

# Extremely Versatile Cordless Stereo & Stereozoom Microscopes

## PROFESSIONAL FEATURES FOR... WELL, EVERYONE

- » Level up skills and become a professional user
- » 3D Greenough view for high resolved images & large field depth
- » 6.43:1 ratio - 7x ... 45x - or turnable objective - 2x, 4x - on 21 mm
- » Compact, practical and intuitive to use
- » Sturdy and durable for extended lifetime

## THE LONGEST AUTONOMY ON THE MARKET

- » Longlife LED illumination (providing over 20 years of use)
- » Ultra-flat base with  $\varnothing$  100 mm disc for diffused transmitted light
- » Cordless use, totally independent from mains/batteries connection
- » Freely settable illumination - incident, oblique and transmitted light
- » External power supply for enhanced safety and convenient servicing

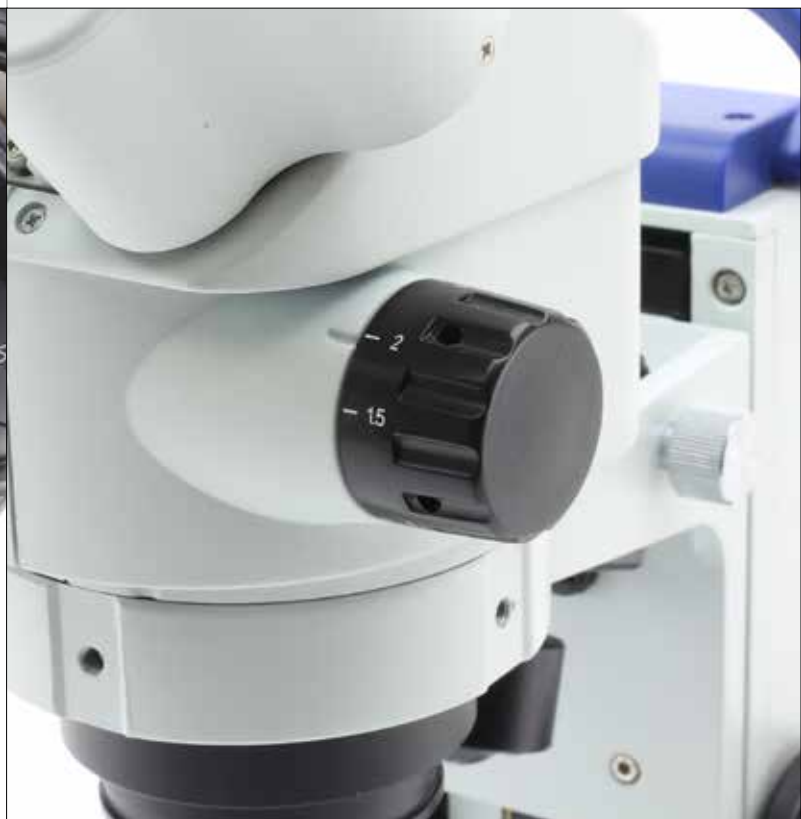

# SLX Series

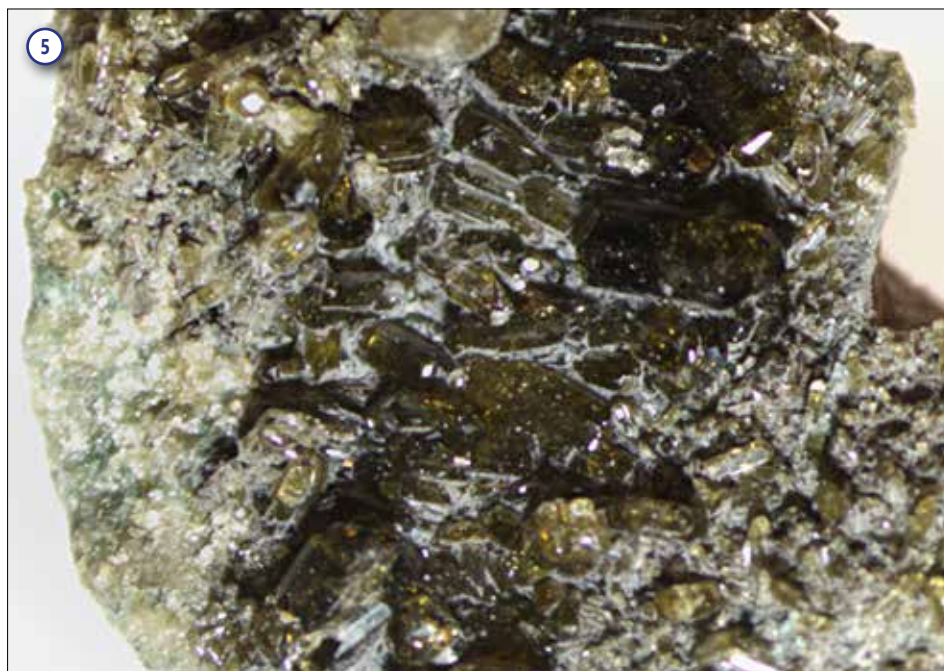
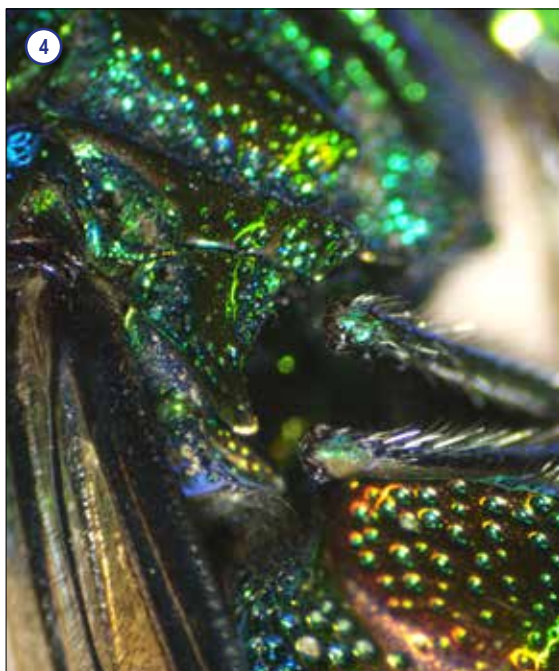

## Legend

- |   |                                       |
|---|---------------------------------------|
| 1. Aluminum - SLX-1 and 4x objective.             | 4. Fly, detail - SLX-2 and 4.5x zoom. |
| 2. Component worked on lathe - SLX-2 and 3x zoom. | 5. Rock - SLX-2 - 1.5x zoom.          |
| 3. Wasp - SLX-3 and 4x zoom.                      |                                       |



## SLX Series

Valuable configurations of cordless and modern stereo & stereozoom microscopes ideal for a variety of applications, including dissection, biology, entomology, anatomy, chemistry, material science among the others and even industrial purposes.

Provided with dual magnification or **6.43:1 zoom ratio**, **FN 21** high eyepoint eyepieces, high-grade precise fixed arm with focus and handle with the latest technology of **EcoLED™** illumination plus rechargeable batteries. Slim and easy to carry, all the models with high-grade precise fixed arm are equipped with long lasting **LED** illumination to provide over 20 years of use.

### High eyepoint eyepieces for glasses wearers

These eyepieces are designed in such a way that the exit pupil is further away from the eye lens than standard eyepieces, being well suited for eyeglasses wearers

### The longest autonomy on the market ensured by EcoLED™

OPTIKA has re-designed illumination in microscopy, once again: a special coating process on optics combined with a new, higher ratio between low consumptions and ultra-efficiency has addressed us to top brightness levels

### 6.43:1 zoom ratio - zoom magnification from 7x to 45x

Purposely designed for professional routine inspections, the total magnification can be even extended to 135x with 20x eyepieces and 1.5x additional lens, obtaining an excellent results in this class



### Ultra-flat base with Ø 100 mm disc for diffused transmitted light

A new level of ergonomics and comfort is achieved during operations, with the ultra-flat base of only 3 cm height to ensure smooth specimen movement and the Ø 100 mm for top class diffusion of the transmitted light



# Stereomicroscopes For Higher Education & Laboratory



### Longlife LED illumination (providing over 20 years of use)

Money & energy saving thanks to LED long lifetime (65.000 hours, 22 years in case of 8 hours/day) which is more than 20 times compared to a standard halogen bulb

### Cordless use, totally independent from mains/batteries connection

All models work with or without the batteries in place and are provided with three NiMH rechargeable batteries for the longest autonomy in outdoor use (12-hour autonomy, at medium intensity)



### External power supply for enhanced safety and convenient servicing

OPTIKA's safety first approach drives to the use of a low voltage, multi-plug, external power supply in order to prevent any risk of electric shock and heatflow inside the unit

## SLX Series - Get the most out of our accessories

### Additional Lenses

Simply to be screwed into the threads below the objectives of SLX-2 and SLX-3 to either increase or decrease total magnification, or to increase the working distance when users need to work with hands under the microscope



ST-091 - Additional lens 0.75x

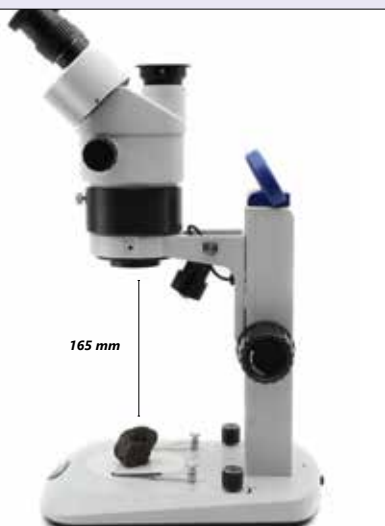

ST-085.1 - Additional lens 0.5x (w.d. 165mm) with SZ-EXT

### ST-040.1 - Darkfield condenser

This is a darkfield condenser for stereo microscopes with bottom light and 100 mm round working plate to provide dark-field microscopy features, fitting all OPTIKA stereomicroscopes with 100 mm mounting size and transmitted light

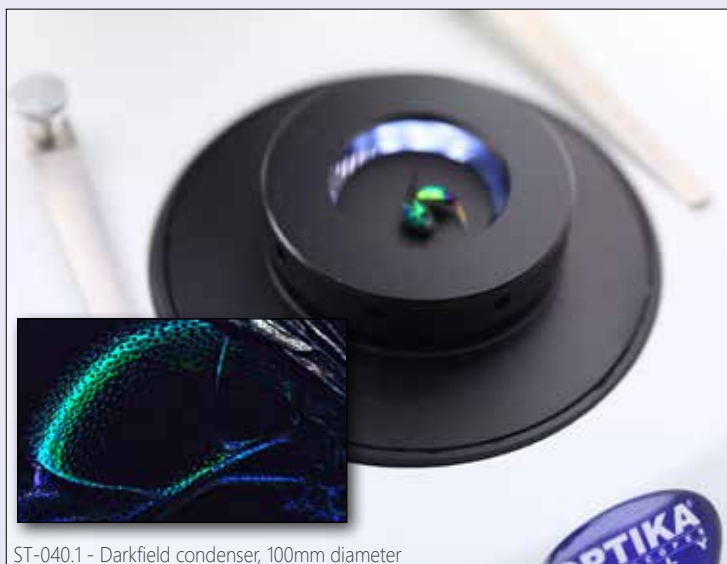

ST-040.1 - Darkfield condenser, 100mm diameter

# SLX Series - Range

## SLX-1

- 21
- EcoLED
- EcoLED
- 
- 2x-4x
- 



Cordless binocular stereomicroscope ideal for students, schools and amateurs to dissect and discover mainly biology and materials science in 3D, with turnable objective (2x-4x), FN 21 high eyepoint, precision fixed arm with handle and the latest technology of EcoLED™ illumination plus rechargeable batteries. Slim and easy to carry, it is equipped with long lasting LED illumination to provide over 20 years of use.

<b>Head:</b> Binocular, 45° inclined; 360° rotating.
<b>Dioptric adjustment:</b> Left eyepiece.
<b>Eyepieces:</b> WF10x/21 mm, high eyepoint, secured by screw and with rubber cups.
<b>Objective:</b> Achromatic 2x-4x with anti-fungus treatment.
<b>Working distance:</b> 100 mm.
<b>Stand:</b> High-grade, precision fixed with handle and focus.
<b>Focusing:</b> Rack and pinion focusing mechanism.
<b>Illumination:</b> EcoLED™ swiveling incident and transmitted, with brightness control, rechargeable batteries. Color temperature: 6,300 K. Multi-plug 100-240Vac/5Vdc external power supply.

## SLX-2

- 21
- EcoLED
- EcoLED
- 
- 0.7x-4.5x
- 



Cordless binocular stereozoom microscope ideal for students, schools and amateurs to dissect and discover mainly biology and materials science in 3D, with 0.7x...4.5x zoom, FN 21 high eyepoint, precision fixed arm with handle and the latest technology of EcoLED™ illumination plus rechargeable batteries. Slim and easy to carry, it is equipped with long lasting LED illumination to provide over 20 years of use.

<b>Head:</b> Binocular, 45° inclined; 360° rotating.
<b>Dioptric adjustment:</b> Both eyepieces.
<b>Eyepieces:</b> WF10x/21 mm, high eyepoint, secured by screw and with rubber cups.
<b>Objective:</b> Parfocal achromatic zoom 0.7x...4.5x (6.43:1 ratio) with anti-fungus treatment.
<b>Working distance:</b> 100 mm.
<b>Stand:</b> High-grade, precision fixed with handle and focus.
<b>Focusing:</b> Rack and pinion focusing mechanism.
<b>Illumination:</b> EcoLED™ swiveling incident and transmitted, with brightness control, rechargeable batteries. Color temperature: 6,300 K. Multi-plug 100-240Vac/5Vdc external power supply.

# SLX Series - Range

## SLX-3

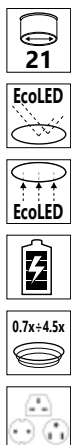

Cordless trinocular stereozoom microscope ideal for students, schools and amateurs to dissect and discover mainly biology and materials science in 3D, with 0.7x...4.5x zoom, FN 21 high eyepoint, precision fixed arm with handle and the latest technology of EcoLED™ illumination plus rechargeable batteries. Slim and easy to carry, it is equipped with long lasting LED illumination to provide over 20 years of use.

**Head:** Trinocular (split ratio: 50/50), 45° inclined; 360° rotating.

**Dioptric adjustment:** Both eyepieces.

**Eyepieces:** WF10x/21 mm, high eyepoint, secured by screw and with rubber cups.

**Objective:** Parfocal achromatic zoom 0.7x...4.5x (6.43:1 ratio) with anti-fungus treatment.

**Working distance:** 100 mm

**Stand:** High-grade, precision fixed with handle and focus.

**Focusing:** Rack and pinion focusing mechanism.

**Illumination:** EcoLED™ swiveling incident and transmitted, with brightness control, rechargeable batteries. Color temperature: 6,300 K. Multi-plug 100-240Vac/5Vdc external power supply.

## SLX Series - Comparison Chart

Model	Head	Eyepieces	Objective	Working Distance	Stand	Illumination
SLX-1	Binocular 45° inclined 360° rotating	WF 10x/21	2x – 4x selectable	100 mm	High-grade, precision fixed with handle and focus	EcoLED™ swiveling incident and transmitted with brightness control, rechargeable batteries
SLX-2	Binocular 45° inclined 360° rotating	WF 10x/21	0.7x...4.5x zoom	100 mm	High-grade, precision fixed with handle and focus	EcoLED™ swiveling incident and transmitted with brightness control, rechargeable batteries
SLX-3	Trinocular (50/50) 45° inclined 360° rotating	WF 10x/21	0.7x...4.5x zoom	100 mm	High-grade, precision fixed with handle and focus	EcoLED™ swiveling incident and transmitted with brightness control, rechargeable batteries

### Optical performance SLX-1

Eye-piece	10x (ST-081)		15x (ST-082)		20x (ST-083)		10x (ST-084)	
Field number (mm)	21		15		10		21	
Additional lens	Total magnification	Field of View (mm)	Total magnification	Field of View (mm)	Total magnification	Field of View (mm)	Total magnification	Field of View (mm)
1x	20x - 40x	10.50 - 5.25	30x - 60x	7.50 - 3.75	40x - 80x	5.00 - 2.50	20x - 40x	10.50 - 5.25

### Optical performance SLX-2 - SLX-3

Eye-piece	10x (ST-081)		15x (ST-082)		20x (ST-083)		10x (ST-084)	
Field number (mm)	21		15		10		21	
Additional lens	Total magnification	Field of View (mm)	Total magnification	Field of View (mm)	Total magnification	Field of View (mm)	Total magnification	Field of View (mm)
0.5x	3.5x - 22.5x	60.00 - 9.33	5.25x - 33.75x	42.86 - 6.67	7x - 45x	28.57 - 4.44	3.5x - 22.5x	60.00 - 9.33
0.75x	5.25x - 33.75x	40.00 - 6.22	7.875x - 50.625x	28.57 - 4.44	10.5x - 67.5x	19.05 - 2.96	5.25x - 33.75x	40.00 - 6.22
1x	7x - 45x	30.00 - 4.67	10.5x - 67.5x	21.43 - 3.33	14x - 90x	14.29 - 2.22	7x - 45x	30.00 - 4.67
1.5x	10.5x - 67.5x	20.00 - 3.11	15.75x - 101.25x	14.29 - 2.22	21x - 135x	9.52 - 1.48	10.5x - 67.5x	20.00 - 3.11

# SLX Series - Accessories

## Eyecups & Eyepieces

- ST-036 Eyecups (pair), curved  
 ST-081 EW10x/21 eyepieces (pair), high eyepoint, with rubber cup  
 ST-082 WF15x/15 eyepieces (pair), high eyepoint  
 ST-083 WF20x/10 eyepieces (pair), high eyepoint  
 ST-084 WF10x/21 micrometric eyepiece, high eyepoint, with rubber cup

## Objectives & Additional Lenses

- ST-085.1 Additional lens 0.5x (w.d. 165mm) with SZ-EXT (only for SLX-2 & SLX-3)  
 ST-091 Additional lens 0.75x (w.d. 105mm) (only for SLX-2 & SLX-3)  
 ST-086.1 Additional lens 1.5x (w.d. 45mm) with compensating disc (only for SLX-2 & SLX-3)

## Stages

- ST-100.1 Hand moving stage, 100mm diameter  
 ST-110.1 Moving stage, coaxial knobs, 100mm diameter  
 ST-111.1 Moving stage, micrometric screws, 100mm diameter  
 ST-666.1-EU Applicable heating stage (stereomicroscopes, 100mm diameter), EU  
 ST-666.1-UK Applicable heating stage (stereomicroscopes, 100mm diameter), UK  
 ST-666.1-US Applicable heating stage (stereomicroscopes, 100mm diameter), US  
 ST-666.1-SW Applicable heating stage (stereomicroscopes, 100mm diameter), CH

## Condensers & Filters

- ST-040.1 Darkfield condenser, 100mm diameter  
 ST-088.1 Polarising set (filters and rotating stage), 100mm diameter

## Camera Adapters

- M-113.1 Ring adapter, 30mm (for monocular and binocular microscopes)  
 M-115 0.35x C-Mount projection lens  
 M-114 0.5x C-Mount projection lens  
 M-118 0.75x C-Mount projection lens  
 M-173 C-Mount projection lens for APS-C/full frame reflex cameras (trino)  
 M-699 Universal adapter for C-Mount projection lens (trino)  
 ST-090 0.35x focusable C-Mount adapter (stereomicroscopes)  
 ST-090.1 0.5x focusable C-Mount adapter (stereomicroscopes)  
 ST-090.2 0.65x focusable C-Mount adapter (stereomicroscopes)  
 M-620.3 1x focusable C-Mount adapter (biological & stereomicroscopes)

## Miscellaneous

- 15104 Cleaning kit  
 DC-002 Plastic dust cover, medium, 490(l)x490(h) mm  
 M-005 Micrometric slide, 26x76mm, with 2 scales (1mm/100 & 10mm/100)  
 ST-041 Sample clip  
 ST-042 White/black object-plate, 100mm diameter  
 ST-043 Glass object-plate, 100mm diameter  
 ST-092 Protective glass for stereohead  
 VP-SLX IQ/OQ/PQ manual for SLX series

### 15104 - Cleaning kit

It cleans glass quickly and effectively, without leaving residue or odor. Ideal for precision lens or prism cleaning.



### How to connect the cameras to our microscopes.

Please refer to the Adapter reference list on Digital section.

v 1.4.0 - OPTIKA reserves the right to make corrections, modifications, enhancements, improvements and other changes to its products at any time without notice.

## Headquarters and Manufacturing Facilities

**OPTIKA® S.r.l.** Via Rigla, 30 - 24010 Ponteranica (BG) - ITALY - Tel.: +39 035.571.392 - info@optikamicroscopes.com

## Optika Sales branches

**OPTIKA® Spain** spain@optikamicroscopes.com  
**OPTIKA® China** china@optikamicroscopes.com  
**OPTIKA® India** india@optikamicroscopes.com

**OPTIKA® USA** usa@optikamicroscopes.com  
**OPTIKA® Central America** america@optikamicroscopes.com

**OPTIKA<sup>®</sup>**  
M I C R O S C O P E S  
I T A L Y



























***LABORATORY Microscopes***

# LABORATORY Microscopes

<b>B-290 SERIES</b> - Entry-Level Lab Upright Microscopes	page 87
<b>B-380 SERIES</b> - Middle-Level Routine Lab Upright Microscopes	page 103
<b>B-510 SERIES</b> - Advanced Routine Lab Upright Microscopes	page 127
<b>B-810/B-1000 SERIES</b> - Research Lab Upright Microscopes	page 153
<b>IM-3 SERIES</b> - Routine Lab Inverted Microscopes	page 197
<b>IM-5 SERIES</b> - Routine & Research Lab Inverted Microscopes	page 211
<b>POL SERIES</b> - Routine & Research Lab Polarizing Microscopes	page 231
<b>FLUO SERIES</b> - Routine & Research Lab Fluorescence Microscopes	page 239

## Icons

	Field number		W-Plan objectives (up to 22mm f.o.v)		Tablet screen size
	Incident light		U-Plan objectives (up to 24mm f.o.v)		Camera resolution
	Transmitted light		Oil/Water 100x objective		Software included
	LED illuminator		Fluorescence		HDMI output
	X-LED illuminator		Metallography		MicroSD slot
	Automatic light control		Polarized light		Wi-Fi
	Multi-Plug low voltage power supply		Darkfield		BlueTooth
	Infinity corrected optics		Phase contrast		
	N-Plan objectives (up to 20mm f.o.v)		USB connection		

**OPTIKA<sup>®</sup>**  
M I C R O S C O P E S  
I T A L Y

## B-290 Series



**Entry-Level Lab Upright Microscopes**

# Best Value-for-Money Solutions & Versatile Use

## SUITABLE FOR UNIVERSITIES, EXPERTS & ROUTINE LABS

- » The ideal choice for common lab requirements
- » Simply engineered for life-science
- » Ready for phase contrast and darkfield

## EXCELLENT PRICE/PERFORMANCE RATIO

- » N-PLAN objectives (160 mm or IOS) for flat images on 20 mm FN
- » Fixed Koehler illumination for crisp and contrasted images
- » Rounded edge, rackless stage to prevent scratches



## B-290TB - BREAK NEW GROUND WITH WINDOWS TABLET

- » Large touch-screen of 10.8" with fast, responsive and smooth control
- » 360° rotatable, tiltable and easily detachable
- » Simultaneous camera & power connection for long-term operation

## B-290LD SERIES - ON-FIELD TBC & MALARIA DIAGNOSIS

- » Ultra-convenient LED fluorescence, blue filter
- » No waiting time, immediate operation
- » Cost-effective, money-saving technology

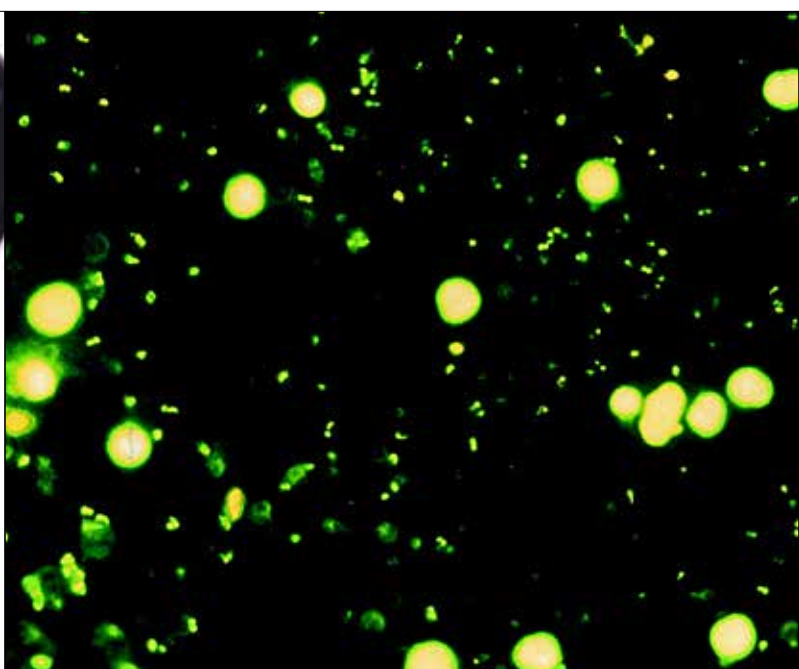



# 100x Oil/Water Objective – Only at OPTIKA

2

## SAME OBJECTIVE FOR OIL AND WATER USE

- » Oil represents the best media for high numerical aperture
- » Water combines results with convenience
- » Water is recommended especially for educational purposes

## UNPARALLELED TIME & MONEY SAVING

- » Save time by forgetting about tedious cleaning
- » No time-wasting procedures for maintenance
- » No additional expenses due to inappropriate cleaning

Laboratory

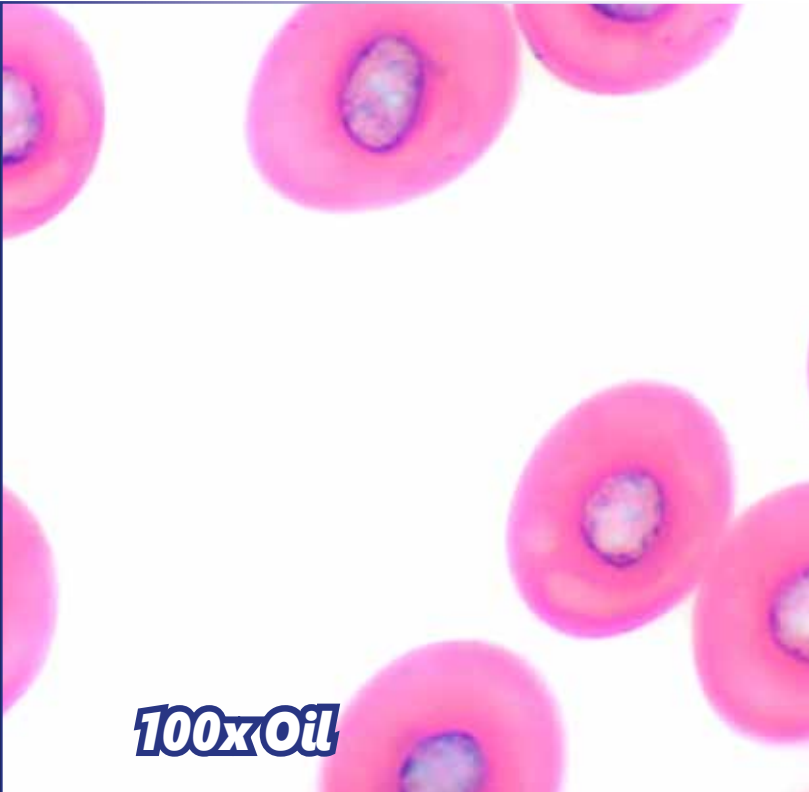

**100x Oil**

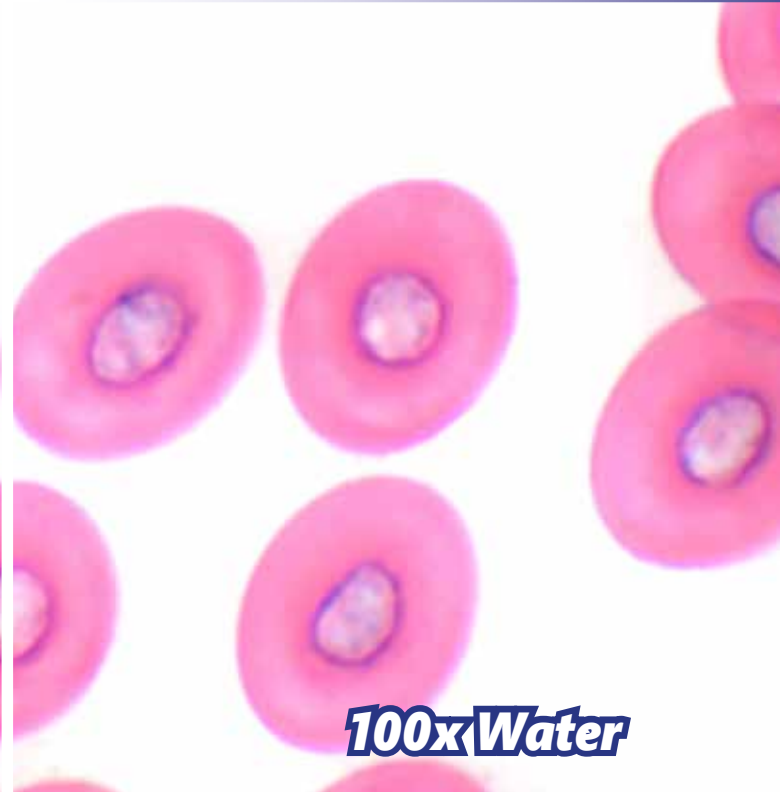

**100x Water**

# X-LED<sup>3</sup> – Only Available at OPTIKA

## STATE-OF-THE-ART ILLUMINATION SYSTEM

- » Uncomparable light intensity, exclusive lens & collector design
- » Constant pure-white colour temperature at all intensity levels
- » Unmatched color fidelity, uniformity and brightness

## CUT ELECTRICITY BILLS BY 90%

- » Money & energy saving, only 3.6 W
- » More efficient brightness than a 50 W halogen lamp
- » LED long lifetime (65,000 hours = 22 years at 8 hours/day usage)

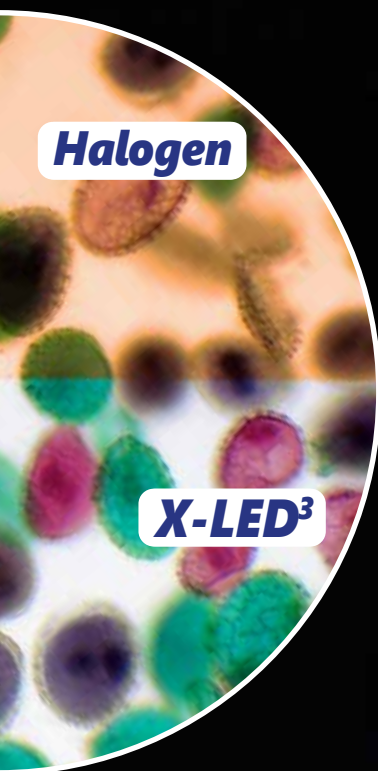
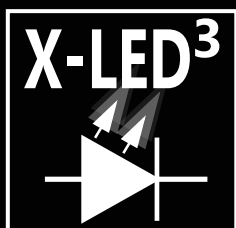

**Halogen**

**X-LED<sup>3</sup>**



Multi-plug power supply

# IOS & Professional Features

## LABORATORY GRADE OPTICS FOR OUTSTANDING IMAGES

- » Planachromatic optics
- » Designed to ensure field flatness on 20 mm (N-PLAN)
- » IOS Infinity corrected optical system

## FULL CONTROL OF YOUR IMAGES

- » Fully settable condenser for perfect imaging
- » Easy to set objective-coded iris diaphragm, focusable & centrabale
- » Phase contrast and darkfield slider available



## B-290 Series

This series incorporates all the experience gathered by OPTIKA Microscopes in the field of light microscopy, adapted specifically for common laboratory applications. Suitable for routine microscopy with brightfield, darkfield, phase contrast and LED fluorescence, designed to last.

### X-LED<sup>3</sup> Exclusive Lighting Source

Special technology able to double the light intensity for incomparable performance, ensuring constant pure-white colour temperature (6,300K colour temperature). Relevant money and energy saving thanks to the incredibly low energy consumptions which allows you to cut the electricity bills by 90%!  
The electric consumption (3.6 W only) proves the high efficiency of this system: incredibly high light intensity combined with low consumption.

### Safe And Convenient Operations

Rounded edge rackless stage has been designed with a belt-driven mechanism that allows a smooth movement without any protruding part.  
This design gives you a more compact solution and lowers any risk of injury after accidentally hitting the rack with your hands.

### Clear Observation With 100x Objective

Students and basic users will enjoy B-290 Series for the clear and sharp images they can get using 100x objective with water, thanks to the extremely bright X-LED<sup>3</sup> light source and the fully centerable Abbe condenser. Forget about the tedious lens cleaning you are used to when using 100x objective: dirt and dust will not affect your objective.

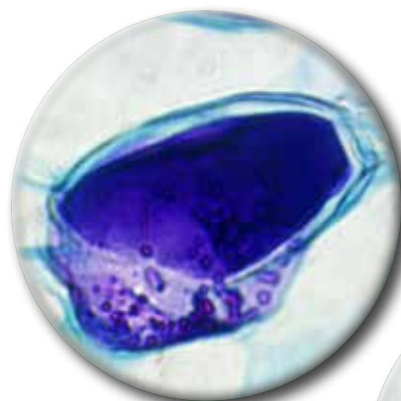

100x DRY

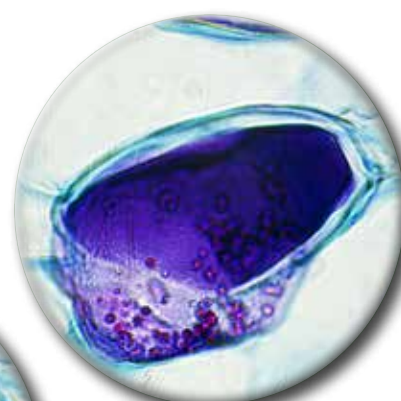

100x OIL

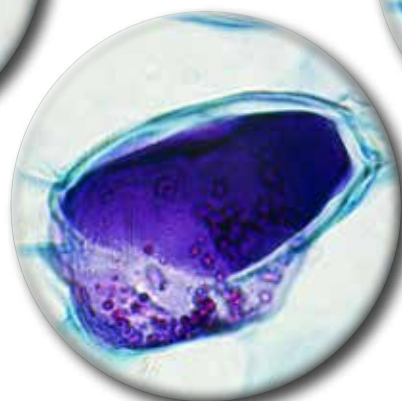

100x WATER

### Pine, one year stem.

For a professional use, immersion oil is the recommended solution to get the best performance available from any 100x objective.



## Entry-Level Lab Upright Microscopes

### Laboratory Grade Optics, N-PLAN & IOS N-PLAN System

OPTIKA N-PLAN objectives ensure bright, clear images with excellent flatness and compensation for chromatic aberration. IOS Infinity-corrected optical system prevents image deterioration even if other optical components are added, such as polarizers, beamsplitters and so on.

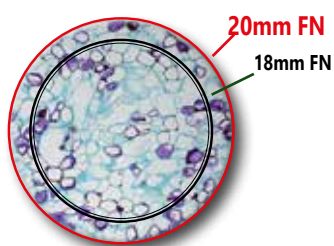

### Large Specimen View (20 mm Field Number)

The **F.O.V.** (field of view) is based on a comfortable diameter of 20 mm. This means that a wide area of the sample can be inspected and allows a natural and easy view, particularly needed in a laboratory environment.

### Easy Transportation

B-290 has a carefully shaped design that gives stability and ease in the transportation. Thanks to the handle on the back, it can be safely moved around the classroom or the laboratory.



## Get the most out of our accessories



### M-666.290 Heating stage

Use the temperature controlled heating stage for specific applications where accurate temperature selection up to 50° C and programmable settings are needed. Requested in research arenas such as microbiology, biochemistry, material science, pharmacology, crystallographic characterization, surface quality control, and in all the temperature related inspections.

### M-184 Darkfield condenser

With optional diaphragm M-184 you can easily obtain a darkfield view for dry objectives. M-184 can be placed directly under the condenser without the need of additional operations.



**DARKFIELD CONDENSER**

## B-290 Series

### Legend

1. B-290TB with 360° rotating tablet PC for discussion.
2. Pine, one year stem, with B-292 and 10x objective.
3. B-290 Series exclusive X-LED<sup>3</sup> illumination system.
4. B-293 used by a teacher.
5. Lilly pollen, with B-292PLi and 20x objective.
6. Ascaris female, with B-293 and 40x objective.
7. Student setting the right focusing on a B-290TB.

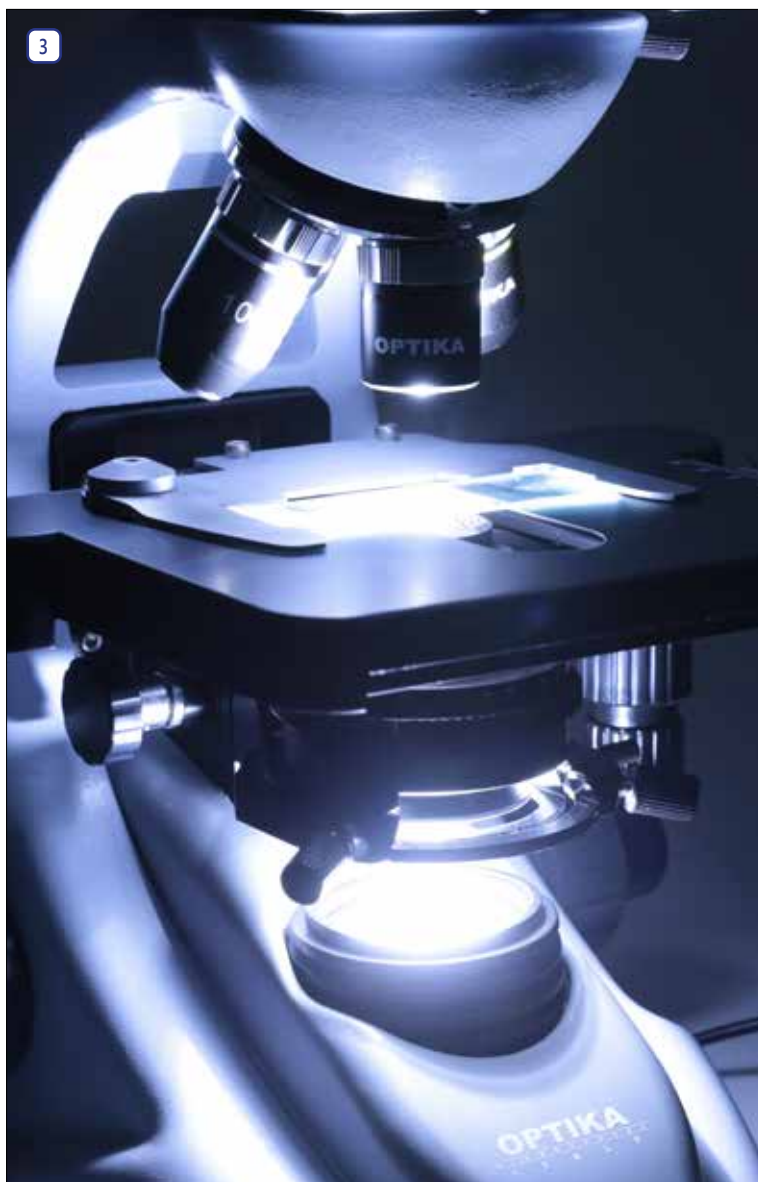
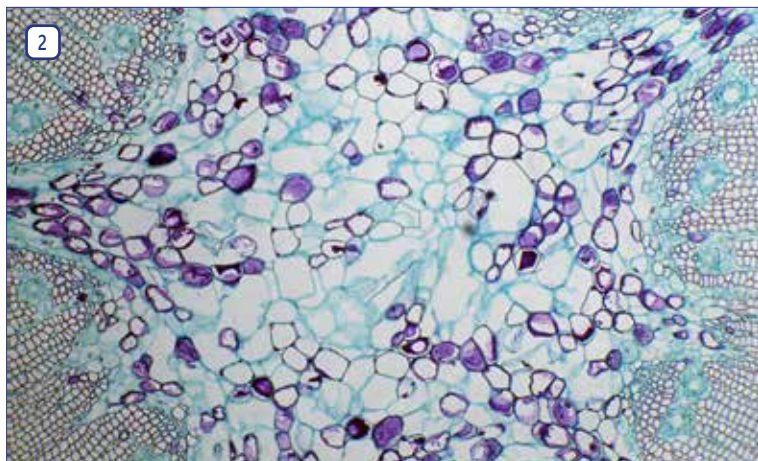

## Entry-Level Lab Upright Microscopes

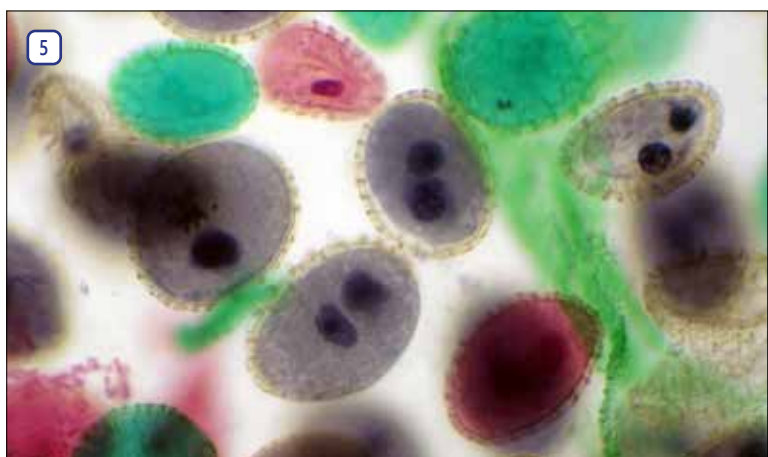

# B-290 Series - Brightfield Models

## B-292



Binocular head with N-PLAN objectives, rackless stage and exclusive **X-LED<sup>3</sup>** for unmatched performance, powerful and uniform illumination.

**Observation mode:** Brightfield.

**Head:** Binocular, 30° inclined and 360° rotating. Interpupillary distance 48-75 mm.

**Dioptric adjustment:** On the left eyepiece tube.

**Eyepieces:** WF10x/20 mm, high eye-point and secured by screw.

**Nosepiece:** Quadruple revolving nosepiece, rotation on ball bearings.

**Objectives:**

N-PLAN 4x/0.10                                  N-PLAN 10x/0.25  
 N-PLAN 40x/0.65    N-PLAN 100x/1.25 (Oil/Water)  
 All with anti-fungus treatment.

**Specimen stage:** Double layer rackless mechanical sliding stage, 150x139 mm, 75x33 mm X-Y movement range. Vernier scale on the two axes, accuracy: 0.1 mm.

**Focusing:** Coaxial coarse and fine focusing mechanism with limit stop to prevent the contact between objective and specimen. Adjustable tension of coarse focusing knob.

**Condenser:** Abbe N.A. 1.25, with objective-coded iris diaphragm, focusable and centerable.

**Illumination (Fixed Koehler type):** X-LED<sup>3</sup> with white 3.6 W LED (6,300 K) and light intensity control. Multi-plug 100-240Vac/6Vdc external power supply.

## B-293



Trinocular head with N-PLAN objectives, rackless stage and exclusive **X-LED<sup>3</sup>** for unmatched performance, powerful and uniform illumination.

**Observation mode:** Brightfield.

**Head:** Trinocular (fixed, 50/50), 360° rotating and 30° inclined. Interpupillary distance 48-75 mm.

**Dioptric adjustment:** On the left eyepiece tube.

**Eyepieces:** WF10x/20 mm, high eye-point and secured by screw.

**Nosepiece:** Quadruple revolving nosepiece, rotation on ball bearings.

**Objectives:**

N-PLAN 4x/0.10                                  N-PLAN 10x/0.25  
 N-PLAN 40x/0.65    N-PLAN 100x/1.25 (Oil/Water)  
 All with anti-fungus treatment.

**Specimen stage:** Double layer rackless mechanical sliding stage, 150x139 mm, 75x33 mm X-Y movement range. Vernier scale on the two axes, accuracy: 0.1 mm.

**Focusing:** Coaxial coarse and fine focusing mechanism with limit stop to prevent the contact between objective and specimen. Adjustable tension of coarse focusing knob.

**Condenser:** Abbe N.A. 1.25, with objective-coded iris diaphragm, focusable and centerable.

**Illumination (Fixed Koehler type):** X-LED<sup>3</sup> type with white 3.6 W LED (6,300 K) and light intensity control. Multi-plug 100-240Vac/6Vdc external power supply.



# B-290 Series - Brightfield Models

## B-292PLi



Binocular head with IOS N-PLAN (infinity corrected) objectives, rackless stage and exclusive **X-LED<sup>3</sup>** for incredibly bright illumination.

**Observation mode:** Brightfield.

**Head:** Binocular, 360° rotating and 30° inclined. Interpupillary distance 48-75 mm.

**Dioptric adjustment:** On the left eyepiece tube.

**Eyepieces:** WF10x/20 mm, high eye-point and secured by screw.

**Nosepiece:** Quadruple revolving nosepiece, rotation on ball bearings.

**Objectives:**

IOS N-PLAN 4x/0.10	IOS N-PLAN 10x/0.25
IOS N-PLAN 40x/0.65	IOS N-PLAN 100x/1.25 (Oil/Water)

All with anti-fungus treatment.

**Specimen stage:** Double layer rackless mechanical sliding stage, 150x139 mm, 75x33 mm X-Y movement range. Vernier scale on the two axes, accuracy: 0.1 mm.

**Focusing:** Coaxial coarse and fine focusing mechanism with limit stop to prevent the contact between objective and specimen. Adjustable tension of coarse focusing knob.

**Condenser:** Abbe N.A. 1.25, with objective-coded iris diaphragm, focusable and centerable.

**Illumination (Fixed Koehler type):** X-LED<sup>3</sup> type with white 3.6 W LED (6,300 K) and light intensity control.  
Multi-plug 100-240Vac/6Vdc external power supply.

## B-293PLi



Trinocular head with IOS N-PLAN (infinity corrected) objectives, rackless stage and exclusive **X-LED<sup>3</sup>** for incredibly bright illumination.

**Observation mode:** Brightfield.

**Head:** Trinocular (fixed, 50/50), 360° rotating and 30° inclined. Interpupillary distance 48-75 mm.

**Dioptric adjustment:** On the left eyepiece tube.

**Eyepieces:** WF10x/20 mm, high eye-point and secured by screw.

**Nosepiece:** Quadruple revolving nosepiece, rotation on ball bearings.

**Objectives:**

IOS N-PLAN 4x/0.10	IOS N-PLAN 10x/0.25
IOS N-PLAN 40x/0.65	IOS N-PLAN 100x/1.25 (Oil/Water)

All with anti-fungus treatment.

**Specimen stage:** Double layer rackless mechanical sliding stage, 150x139 mm, 75x33 mm X-Y movement range. Vernier scale on the two axes, accuracy: 0.1 mm.

**Focusing:** Coaxial coarse and fine focusing mechanism with limit stop to prevent the contact between objective and specimen. Adjustable tension of coarse focusing knob.

**Condenser:** Abbe N.A. 1.25, with objective-coded iris diaphragm, focusable and centerable.

**Illumination (Fixed Koehler type):** X-LED<sup>3</sup> type with white 3.6 W LED (6,300 K) and light intensity control.  
Multi-plug 100-240Vac/6Vdc external power supply.

# B-290TB - Digital Microscope with Camera & Tablet

## B-290TB



3.1 MP Built-in camera and 10.8" Windows tablet PC with N-PLAN objectives, rackless stage and exclusive **X-LED<sup>3</sup>** for unmatched performance in illumination. Ideal for discussion group with 360° rotating tablet.

**Observation mode:** Brightfield.

**Head:** Binocular, 360° rotating and 30° inclined. Interpupillary distance from 48 to 75 mm; dioptic adjustment on left eyepiece. Built-in 3.1 MP camera.

**Dioptic adjustment:** On the left eyepiece tube.

**Eyepieces:** WF10x/20 mm, high eye-point and secured by screw.

**Nosepiece:** Quadruple revolving nosepiece, rotation on ball bearings.

**Objectives:**

N-PLAN 4x/0.10	N-PLAN 10x/0.25
N-PLAN 40x/0.65	N-PLAN 100x/1.25 (Oil/Water)

All with anti-fungus treatment.

**Specimen stage:** Double layer rackless mechanical sliding stage, 150x139 mm, 75x33 mm X-Y movement range. Vernier scale on the two axes, accuracy: 0.1 mm.

**Focusing:** Coaxial coarse and fine focusing mechanism with limit stop to prevent the contact between objective and specimen. Adjustable tension of coarse focusing knob.

**Condenser:** Abbe N.A. 1.25, with objective-coded iris diaphragm, focusable and centerable.

**Illumination (Fixed Koehler type):** X-LED<sup>3</sup> type with white 3.6 W LED (6,300 K) and light intensity control. Multi-plug 100-240Vac/6Vdc external power supply.



### UNIQUE FEATURES

- » Simultaneous camera & power connection
- » Equipped with the latest Windows OS & Intel processor
- » Easily detachable, can be used as a laptop (keyboard included)

# B-290TB - Digital Microscope with Camera & Tablet

The latest OPTIKA digital microscopes with Windows tablet PC open new microscopy horizons, combining high-end optics with innovative digital technology for microscopic imaging. B-290TB includes a 3MP camera with a 10.1" Windows tablet. View, capture, analyze and share your images with simplicity and reliability.

## TABLET TECHNICAL SPECIFICATIONS

Model	Tablet 10.8"
Operating System	Windows 10 32-bit
Language	Multilanguages already installed
Image capturing software	OPTIKA Vision lite
CPU	Intel® Atom™ Z3735F, Quad core
CPU speed	1.44 GHz
Graphics Card	Intel® HD Graphics 3D Accelerator
Memory	Ram 2,048 GB DDR3L
LCD display	<b>LED 10.1" IPS Multi Touch Screen</b>
LCD resolution	1920 x 1280, 16/10 (WXGA)
Storage	HDD 64GB
Network	Wireless, Bluetooth 4.0
Input/output ports	Micro USB-B - USB - Microphone - MicroSD card reader Mini HDMI - Head-phone
Control Buttons	Auto rotate off, volume control
Battery Technology	Lithium-ion battery, 2x cell
Battery capacity	8400 mAh
Max load	15 W
Dimensions	Thickness 10,5 mm, Height 17,4 cm, Width 25,7 cm
Weight	720 g
Cables included	USB-B to USB-A / OTG cable (Micro USB-B to USB-A)
Also included	Instruction manual, Keyboard with touchpad, touch pen.

## CAMERA TECHNICAL SPECIFICATIONS

Digital camera resolution	3MP
Signal output	USB 2.0
Sensor Size	1/2.5"
Sensor technology	CMOS
Image format	4\3
Full Image size	2048 x 1536
Pixel size	2.2 x 2.2 micron
Frame rate full resolution	5 frames\sec
Frame rate other resolutions	8 fps (1280x1024) - 30 fps (640x480)
Automatic White Balance	Auto - Man
Automatic Gain Control	Auto - Man
Automatic Back light control	Auto - Man
Exposure control	Auto - Man

## Intuitive, Yet Powerful Software

Simple and user-friendly, ideal for students and experienced users.



## 360° Rotating & Tilting



## Detachable



# 2 B-290LD - LED Fluorescence Microscopes

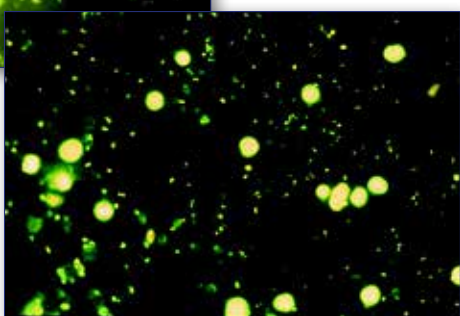
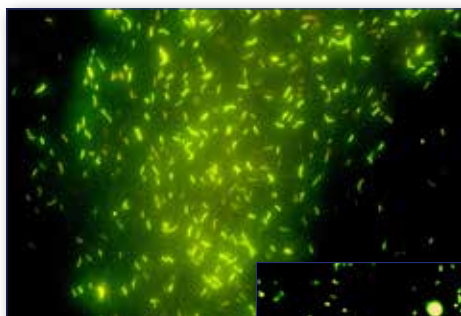

Fluorescence binocular and trinocular microscopes especially designed for tuberculosis and malaria analysis.

**Observation mode:** Brightfield.

**Head:** Binocular or trinocular, 360° rotating and 30° inclined. Interpupillary distance 48-75mm.

**Dioptric adjustment:** On the left eyepiece tube.

**Eyepieces:** WF10x/20 mm, high eye-point and secured by a screw.

**Nosepiece:** Quadruple revolving nosepiece, rotation on ball bearings.

**Specimen stage:** Double layer rackless mechanical sliding stage, 150x139 mm, 75x33 mm X-Y movement range. Vernier scale on the two axes, accuracy: 0.1 mm.

**Focusing:** Coaxial coarse and fine focusing mechanism with limit stop to prevent the contact between objective and specimen. Adjustable tension of coarse focusing knob.

**Condenser:** Abbe N.A. 1.25, with objective-coded iris diaphragm, focusable and centerable.

**Brightfield Illumination (Fixed Koehler type):** X-LED<sup>3</sup> with white 3.6 W LED (6,300 K) and light intensity control. Multi-plug 100-240Vac/6Vdc external power supply.

**Fluorescence Illumination:** Extra efficiency LED, with light intensity control. Peak wavelength: 465 nm, Power: 3.6W.

**Epi Fluorescence Attachment:** Slider with 3 positions (2 fluorescence, 1 brightfield), with 1 included filterset: Fluorescence B: EX 460-490, DM 505, EM 515LP: Acridine Yellow, Acridine Orange, Auramine, DiO, DTAF, FITC, GFP, YFP, etc.

**Part number: B-292LD1.50**

Equipped with binocular head and following objectives:  
 IOS N-PLAN 10x/0.25 (Cover/No Cover), with anti-fungus treatment  
 IOS N-PLAN 20x/0.40 (Cover/No Cover), with anti-fungus treatment  
 IOS N-PLAN 40x/0.65 (Cover/No Cover), with anti-fungus treatment  
 IOS W-PLAN MET 50x/0.75 (No Cover), with anti-fungus treatment.

**Part number: B-293LD1.50**

Trinocular version of B-292LD1.50.

**Part number: B-292LD1**

Equipped with binocular head and following objectives:  
 IOS N-PLAN 10x/0.25 (Cover/No Cover), with anti-fungus treatment  
 IOS N-PLAN 20x/0.40 (Cover/No Cover), with anti-fungus treatment  
 IOS N-PLAN 40x/0.65 (Cover/No Cover), with anti-fungus treatment  
 IOS W-PLAN 100x/0.80 (No Cover, Dry), with anti-fungus treatment.

**Part number: B-293LD1**

Trinocular version of B-292LD1.

**Standard filterset**

Name	Excitation filter (nm)	Dichroic mirror cut-off (nm)	Emission filter (nm)
B (Blue)	460 – 490	505	515LP

# B-290 Series - Comparison Chart

Model	Head	Eyepieces	Nosepiece	Objectives	Stage	Focusing	Condenser	Illumination
<b>B-292</b>	Binocular, 30° inclined, 360° rotating	WF 10x/20	Quadruple, reversed	N-PLAN 4x, 10x, 40x, 100x (oil/water)	Double layer, 150x139 mm, moving range 75x33 mm, X-axis rackless	Coaxial coarse and fine, limit stop	Abbe N.A. 1.25, iris diaphragm, focusable and centrabale	3.6 W X-LED <sup>3</sup> , brightness control. Fixed Koehler
<b>B-292PLI</b>	Binocular, 30° inclined, 360° rotating	WF 10x/20	Quadruple, reversed	IOS N-PLAN 4x, 10x, 40x, 100x (oil/water)	Double layer, 150x139 mm, moving range 75x33 mm, X-axis rackless	Coaxial coarse and fine, limit stop	Abbe N.A. 1.25, iris diaphragm, focusable and centrabale	3.6 W X-LED <sup>3</sup> , brightness control. Fixed Koehler
<b>B-293</b>	Trinocular, 30° inclined, 360° rotating	WF 10x/20	Quadruple, reversed	N-PLAN 4x, 10x, 40x, 100x (oil/water)	Double layer, 150x139 mm, moving range 75x33 mm, X-axis rackless	Coaxial coarse and fine, limit stop	Abbe N.A. 1.25, iris diaphragm, focusable and centrabale	3.6 W X-LED <sup>3</sup> , brightness control. Fixed Koehler
<b>B-293PLI</b>	Trinocular, 30° inclined, 360° rotating	WF 10x/20	Quadruple, reversed	IOS N-PLAN 4x, 10x, 40x, 100x (oil/water)	Double layer, 150x139 mm, moving range 75x33 mm, X-axis rackless	Coaxial coarse and fine, limit stop	Abbe N.A. 1.25, iris diaphragm, focusable and centrabale	3.6 W X-LED <sup>3</sup> , brightness control. Fixed Koehler
<b>B-290TB</b>	Binocular, 30° inclined, 360° rotating, with tablet	WF 10x/20	Quadruple, reversed	N-PLAN 4x, 10x, 40x, 100x (oil/water)	Double layer, 150x139 mm, moving range 75x33 mm, X-axis rackless	Coaxial coarse and fine, limit stop	Abbe N.A. 1.25, iris diaphragm, focusable and centrabale	3.6 W X-LED <sup>3</sup> , brightness control. Fixed Koehler

Model	Head	Eyepieces	Nosepiece	Objectives	Stage	Condenser	Fluorescence	Illumination
<b>B-292LD1.50</b>	Binocular, 30° inclined, 360° rotating	WF 10x/20	Quadruple, reversed	IOS N-PLAN 10x, 20x, 40x. W-PLAN MET 50x	Double layer, 150x139 mm, moving range 75x33 mm, X-axis rackless	Abbe N.A. 1.25, iris diaphragm, focusable and centrabale	3.6 W Fluo LED; Blue Filterset	3.6 W X-LED <sup>3</sup> , brightness control
<b>B-292LD1</b>	Binocular, 30° inclined, 360° rotating	WF 10x/20	Quadruple, reversed	IOS N-PLAN 10x, 20x, 40x. W-PLAN 100x (dry)	Double layer, 150x139 mm, moving range 75x33 mm, X-axis rackless	Abbe N.A. 1.25, iris diaphragm, focusable and centrabale	3.6 W Fluo LED; Blue Filterset	3.6 W X-LED <sup>3</sup> , brightness control
<b>B-293LD1.50</b>	Trinocular, 30° inclined, 360° rotating	WF 10x/20	Quadruple, reversed	IOS N-PLAN 10x, 20x, 40x. W-PLAN MET 50x	Double layer, 150x139 mm, moving range 75x33 mm, X-axis rackless	Abbe N.A. 1.25, iris diaphragm, focusable and centrabale	3.6 W Fluo LED; Blue Filterset	3.6 W X-LED <sup>3</sup> , brightness control
<b>B-293LD1</b>	Trinocular, 30° inclined, 360° rotating	WF 10x/20	Quadruple, reversed	IOS N-PLAN 10x, 20x, 40x. W-PLAN 100x (dry)	Double layer, 150x139 mm, moving range 75x33 mm, X-axis rackless	Abbe N.A. 1.25, iris diaphragm, focusable and centrabale	3.6 W Fluo LED; Blue Filterset	3.6 W X-LED <sup>3</sup> , brightness control

## Optical performance B-292, B-293 and B-290TB

Eyepiece		10x (M-160)			15x (M-161)		20x (M-162)	
Field number (mm)		20			16		10	
Objective	N.A.	W.D (mm)	Total magnification	Field of View (mm)	Total magnification	Field of View (mm)	Total magnification	Field of View (mm)
4x (N-PLAN 160 mm)	0.10	15.20	40x	5	60x	4	80x	2.5
10x (N-PLAN 160 mm)	0.25	5.50	100x	2	150x	1.6	200x	1
20x (N-PLAN 160 mm)	0.40	5.00	200x	1	300x	0.8	400x	0.5
40x (N-PLAN 160 mm)	0.65	0.45	400x	0.5	300x	0.4	800x	0.25
60x (N-PLAN 160 mm)	0.80	0.13	600x	0.33	900x	0.26	1200x	0.16
100x (N-PLAN 160 mm)	1.25 (oil/water)	0.13	1000x	0.2	1500x	0.16	2000x	0.1

## Optical performance B-292PLI, B-293PLI and LD models

Eyepiece		10x (M-160)			15x (M-161)		20x (M-162)	
Field number (mm)		20			16		10	
Objective	N.A.	W.D (mm)	Total magnification	Field of View (mm)	Total magnification	Field of View (mm)	Total magnification	Field of View (mm)
4x (IOS N-PLAN)	0.10	16.80	40x	5	60x	4	80x	2.5
10x (IOS N-PLAN)	0.25	5.80	100x	2	150x	1.6	200x	1
20x (IOS N-PLAN)	0.40	5.10	200x	1	300x	0.8	400x	0.5
40x (IOS N-PLAN)	0.65	0.43	400x	0.5	300x	0.4	800x	0.25
50x (IOS W-PLAN MET, no cover)	0.75	0.32	500x	0.4	750x	0.32	1000x	0.2
60x (IOS N-PLAN)	0.80	0.14	600x	0.33	900x	0.26	1200x	0.16
100x (IOS N-PLAN)	1.25 (oil/water)	0.13	1000x	0.2	1500x	0.16	2000x	0.1
100x (IOS W-PLAN, no cover)	0.80 (dry)	3.20	1000x	0.2	1500x	0.16	2000x	0.1

# B-290 Series - Accessories

## Eyecups & Eyepieces

M-001	Huygens 5x eyepiece
M-008.1	WF10x/20 eyepiece, high eyepoint, with pointer, rubber cup
M-160	EW10x/20 eyepiece, high eyepoint, with rubber cup
M-161	EW15x/16 eyepiece, with rubber cup
M-162	WF20x/10 eyepiece
M-163	EW10x/20 micrometric eyepiece, high eyepoint, with rubber cup

## Objectives & Additional Lenses

### N-PLAN

M-164	N-PLAN objective 4x/0.10
M-165	N-PLAN objective 10x/0.25
M-166	N-PLAN objective 20x/0.40
M-167	N-PLAN objective 40x/0.65
M-168	N-PLAN objective 60x/0.85
M-169	N-PLAN objective 100x/1.25 (oil)

### IOS N-PLAN

M-144	IOS N-PLAN objective 4x/0.10
M-145	IOS N-PLAN objective 10x/0.25
M-146	IOS N-PLAN objective 20x/0.40
M-147	IOS N-PLAN objective 40x/0.65
M-149	IOS N-PLAN objective 60x/0.80
M-148	IOS N-PLAN objective 100x/1.25 (oil)

### IOS W-PLAN

M-634.1	IOS W-PLAN objective 50x/0.95 (oil)
M-1120.N	IOS W-PLAN PH objective 10x/0.25
M-1121.N	IOS W-PLAN PH objective 20x/0.40
M-1122.N	IOS W-PLAN PH objective 40x/0.65
M-335	IOS W-PLAN MET objective 50x/0.75
M-698.2	IOS W-PLAN MET objective 100x/0.80 (dry)

## Stages

M-175	Rotating stage for polarising set (for 150x139mm rackless stage)
M-666.290-EU	Heating stage (on newly purchased microscopes, for 150x139mm), EU
M-666.290-UK	Heating stage (on newly purchased microscopes, for 150x139mm), UK
M-666.290-US	Heating stage (on newly purchased microscopes, for 150x139mm), US
M-666.290-SW	Heating stage (on newly purchased microscopes, for 150x139mm), CH

## Condensers & Filters

M-174	Polarising set (filters only)
M-184	Darkfield stop for condenser
M-971	Plane-concave mirror, with base
M-975	Blue filter, 45mm diameter
M-977	Green filter, 45mm diameter
M-979	Yellow filter, 45mm diameter
M-989	Frosted glass filter, 45mm diameter
M-1124.1	Brightfield condenser (with phase slider slot) (except for B-292, B-293 and B-290TB)
M-1124.NO	Phase contrast condenser with insert slide 10x/20x-40x (except for B-292, B-293 and B-290TB)

## Camera Adapters

M-114	0.5x C-Mount projection lens
M-115	0.35x C-Mount projection lens
M-118	0.75x C-Mount projection lens
M-173	Photo adapter for APS-C and full frame reflex cameras (trino head)

## Miscellaneous

15104	Cleaning kit
15008	Immersion oil, 10ml
15009	Immersion oil, 100ml
DC-002	Plastic dust cover, medium, 490(l)x490(h) mm (except for B-290TB)
DC-003	TNT dust cover, medium, 600(l)x550(h) mm (only for B-290TB)
M-005	Micrometric slide, 26x76mm, with 2 scales (1mm/100 & 10mm/100)
M-069	Solar charger
M-1380	Centering telescope, 23mm diameter (except for B-292, B-293 and B-290TB)
VP-290	IQ/OQ/PQ manual for B-290 series
VP-TB	IQ/OQ/PQ manual for TB series

### M-069 - Solar charger

Included battery: rechargeable – Lithium-Poly.  
Capacity: 2600 mAh.  
Output voltage: 5.5Vdc. - Dimensions: 120x73x10 mm.  
Autonomy: over 6 hours at medium intensity (X-LED<sup>3</sup>).  
Charging modes: with solar panel (12h),  
with external USB power supply (not included)  
or from PC USB port (5h).



### 15104 - Cleaning kit

It cleans glass quickly and effectively, without leaving residue or odor. Ideal for precision lens or prism cleaning.



#### How to connect the cameras to our microscopes.

Please refer to the Adapter reference list on Digital section.

v 1.4.0 - OPTIKA reserves the right to make corrections, modifications, enhancements, improvements and other changes to its products at any time without notice.

## Headquarters and Manufacturing Facilities

**OPTIKA® S.r.l.** Via Rigla, 30 - 24010 Ponteranica (BG) - ITALY - Tel.: +39 035.571.392 - info@optikamicroscopes.com

## Optika Sales branches

**OPTIKA® Spain** spain@optikamicroscopes.com  
**OPTIKA® China** china@optikamicroscopes.com  
**OPTIKA® India** india@optikamicroscopes.com

**OPTIKA® USA** usa@optikamicroscopes.com  
**OPTIKA® Central America** camerica@optikamicroscopes.com

## B-380 Series



**Middle-Level Routine Lab Upright Microscopes**

# Just What You Need. Right When Is Needed

## ROUTINE IN UNIVERSITIES, LABS & INDUSTRIES

- » Wide range to fulfil specific lab requirements
- » Valuable solutions for life and material sciences
- » Compliant with several observation methods

## THE PREFERRED PARTNER FOR ROUTINE TASKS

- » Full planarity optics on 20 mm (N-PLAN) according to ISO 19012-1
- » Fixed Koehler illumination for crisp and contrasted images
- » Rounded edge, rackless stage to prevent scratches



## Multiple Observation Methods

**BRIGHTFIELD**

**METALLOGRAPHY**

**DARKFIELD**

**POLARIZATION**

**FLUORESCENCE**

**PHASE CONTRAST**

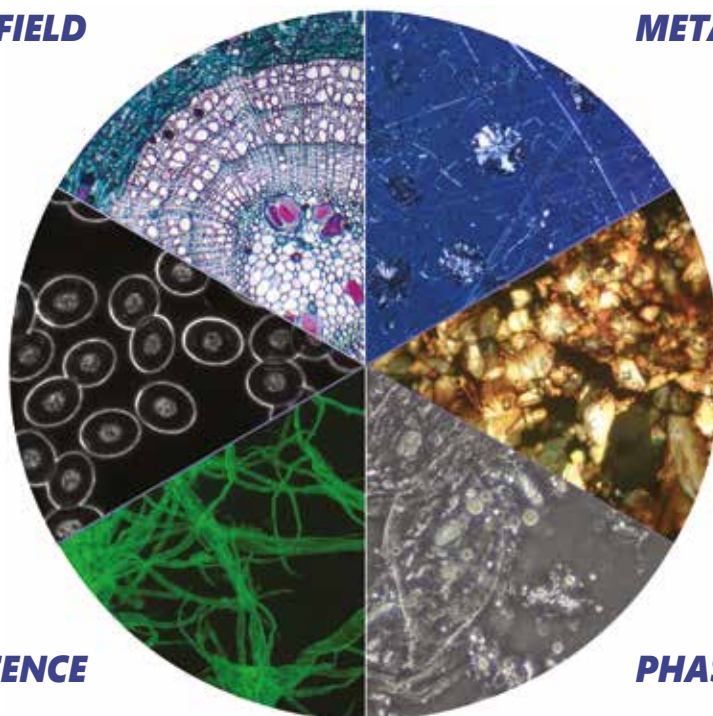



# 100x Oil/Water Objective – Only at OPTIKA

2

## SAME OBJECTIVE FOR OIL AND WATER USE

- » Oil represents the best media for high numerical aperture
- » Water combines results with convenience
- » Water is recommended especially for educational purposes

## UNPARALLELED TIME & MONEY SAVING

- » Save time by forgetting about tedious cleaning
- » No time-wasting procedures for maintenance
- » No additional expenses due to inappropriate cleaning

Laboratory

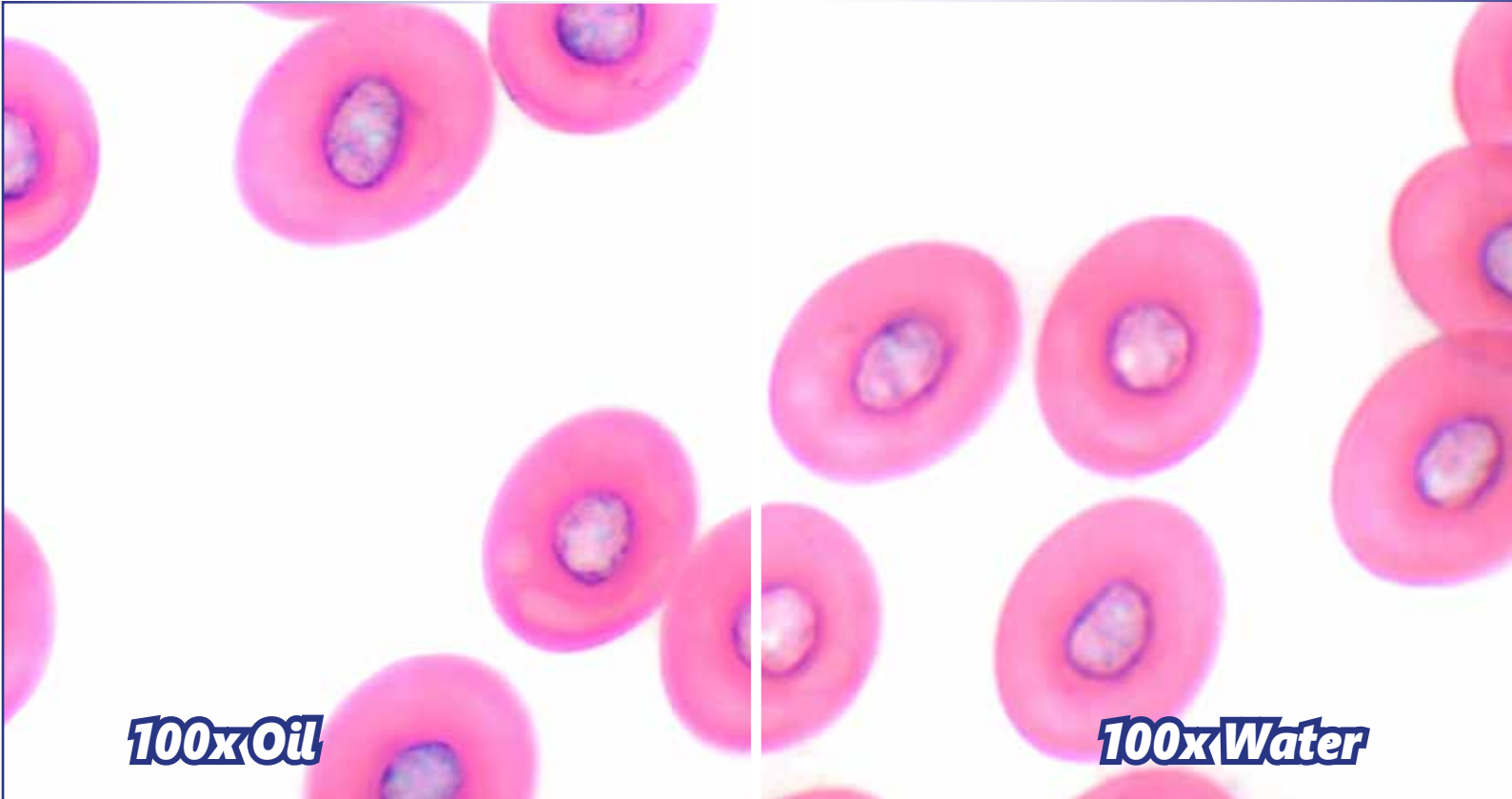

**100x Oil**

**100x Water**

# X-LED<sup>3</sup> – Only Available at OPTIKA

## STATE-OF-THE-ART ILLUMINATION SYSTEM

- » Uncomparable light intensity, exclusive lens & collector design
- » Constant pure-white colour temperature at all intensity levels
- » Unmatched color fidelity, uniformity and brightness

## CUT ELECTRICITY BILLS BY 90%

- » Money & energy saving, only 3.6 W
- » More efficient brightness than a 50 W halogen lamp
- » LED long lifetime (65,000 hours = 22 years at 8 hours/day usage)



**Halogen**

**X-LED<sup>3</sup>**

Multi-plug power supply

# ALC - Only Available At OPTIKA

2

Laboratory

## AUTOMATIC LIGHT CONTROL IN 3 STEPS

- » When another objective is used
- » When the diaphragm aperture changes
- » When processing samples with different opacity

## FORGET ABOUT MANUAL LIGHT ADJUSTEMENT

- » Choose the light intensity according to your preference
- » Press the ALC button and the brightness is saved
- » The microscope will automatically regulate the light

### STEP 1

Set the brightness according to your preferences.



### STEP 2

Press the ALC button to save the brightness level.



### STEP 3

#### **Forget about the illumination!**

The microscope will automatically adjust the brightness for you, in case of:

- Another objective is used
- The diaphragm aperture is changed
- Another specimen with different opacity is processed



# B-380 Series

This series incorporates all the experience gathered by OPTIKA Microscopes in the field of light microscopy, adapted specifically for common laboratory applications.

Suitable for routine microscopy with brightfield, darkfield (oil and dry), phase contrast, fluorescence and polarized light, designed to be extremely stable on the bench and last long.

## Purposely Designed For Intense Use, Effortless

Full of features that help being more comfortable especially in case of long-term use.

All the main controls are located close to each other to enable minimal movements and reinforce the advantages that the ergonomics brings to this series.

## X-LED<sup>3</sup> Exclusive Lighting Source

Special technology able to double the light intensity for incomparable performance, ensuring constant pure-white colour temperature (6,300K colour temperature).

Relevant money and energy saving thanks to the incredibly low energy consumptions which allows you to cut the electricity bills by 90%!

The electric consumption (3.6 W only) proves the high efficiency of this system: incredibly high light intensity combined with low consumption.

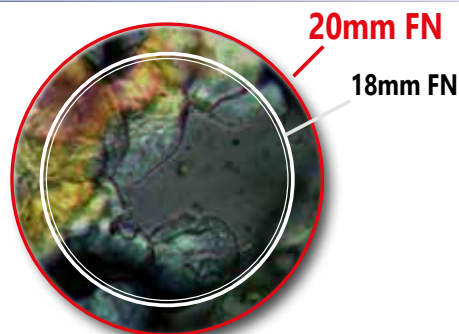

## Large Specimen View (20 mm Field Number)

The **F.O.V.** (field of view) is based on a comfortable diameter of 20 mm.

This means that a wide area of the sample can be inspected and allows a natural and easy view, particularly needed in a laboratory environment.

## ALC - Automatic Light Control, Only Available At OPTIKA

### Incomparable Comfort With The Exclusive Automatic Light Control (ALC)

Light intensity is automatically adjusted by the microscope itself in order to maintain the same level as the one the user has previously chosen.

No matter if the aperture of the diaphragm changes, if another objective is used, and if the opacity of the sample is different...the microscope will set the light for you according to your preferences.

On **ALC Models**.

## Safe And Convenient Operations

Rounded edge rackless stage has been designed with a belt-driven mechanism that allows a smooth movement without any protruding part.

This design gives you a more compact solution and lowers any risk of injury after accidentally hitting the rack with your hands.



# Middle-Level Routine Lab Upright Microscopes

## Universal Condenser For Brightfield, Darkfield & Phase

OPTIKA B-380 phase contrast microscopes are equipped with a 5-position dedicated rotating condenser for brightfield (standard use), phase contrast (10x/20x, 40x and 100x phase diaphragms), and a darkfield position for dry objectives.



## Exclusive X-LED<sup>3</sup> Darkfield Condenser

The special condenser with integrated, exclusive X-LED<sup>3</sup> illuminator replaces any other external and expensive lighting source required for these applications and is ideal for great-looking, rich and high-quality specimen view.

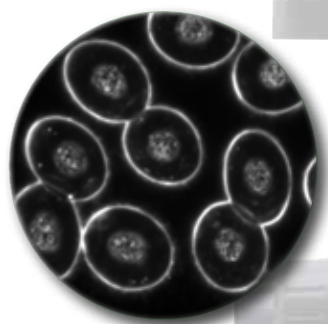

## In fluorescence we can offer several options.

According to your application and to the fluorochromes you are using, we can help you to identify the best light source.

### Traditional, HBO Fluorescence

- » The most used and diffused method, worldwide
- » Wide spectrum range for future upgrades



### Innovative, LED Fluorescence

- » Recommended for routine applications
- » Cost-effective, money saving technology
  - » Ready for immediate operation
  - » Eliminate warm-up/cool-down times
  - » Forget lamp replacement & centering



## B-380 Series



10x - Darkfield

**M-185**  
**Darkfield condenser (dry)**

With M-185 optional condenser you can easily obtain a darkfield view for dry objectives.

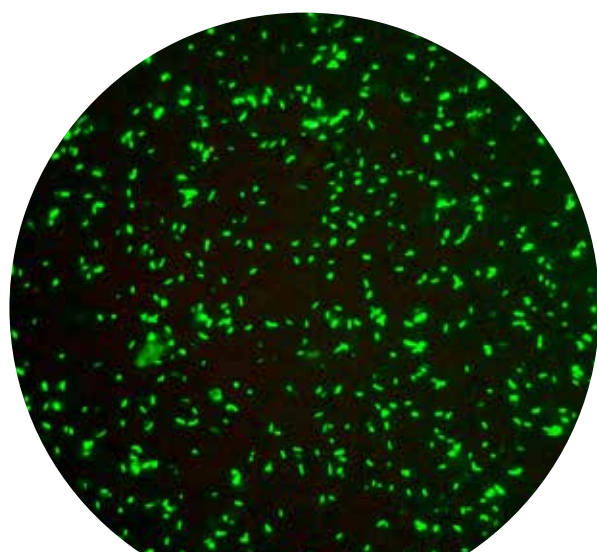

50x - Fluorescence

**M-335**  
**Objective 50x/0.75**  
**IOS W-PLAN MET**

For applications where no cover slide is required (such as sputum smear analysis for tuberculosis diagnosis), the M-335 objective provides excellent results for stunning images.



# Middle-Level Routine Lab Upright Microscopes

## Get the most of our accessories

### M-181

#### Complete Phase Contrast Set with IOS W-PLAN PH obj. 10x, 20x, 40x, 100x, with Darkfield position

The B-380 series can be upgraded at any time with phase contrast kits (M-179 with W-PLAN PH objectives and M-181 with IOS W-PLAN PH objectives) including all the components you need to inspect transparent specimens such as microorganisms, thin tissue slices, lithographic patterns, fibers, glass, etc.

#### M-975.1 Ring with blue filter;

Increase the colour temperature of light (toward the blue).

#### M-977.1 Ring with green filter;

Optimize the resolution of phase contrast.

#### M-979.1 Ring with yellow filter;

Decrease the colour temperature of light (toward the red).

#### M-989.1 Ring with frosted glass filter;

Increase the uniformity of illumination, even further.



Blue filter



Green filter



Yellow filter



Frosted glass

#### M-156 Koehler field diaphragm

Additional field diaphragm for upgrading the Fixed Koehler illumination system to a Full Koehler type. To be ordered on newly purchased B-380 microscope.

#### M-975 Blue filter;

Increase the colour temperature of light (toward the blue).

#### M-977 Green filter;

Optimize the resolution of phase contrast.

#### M-979 Yellow filter;

Decrease the colour temperature of light (toward the red).

#### M-989 Frosted glass filter;

Increase the uniformity of illumination, even further.



# B-380 Series

## Legend

1. Planachromatic Phase Contrast objectives.
2. Coded iris diaphragm for each objective.
3. B-383POL, tuff observed under polarized light.
4. Tilia three year stem at 4x magnification, B-383PL.
5. B-380 head with built-in Automatic Light Control system.
6. Head with Siedentopf adjustment system.
7. B-383POL attachment with Bertrand lens.
8. Handle for easy and comfortable transportation.
9. Coin at 4x magnification, B-383MET.
10. Coin at 50x magnification, B-383MET.
11. Innovative design of B-380 series.

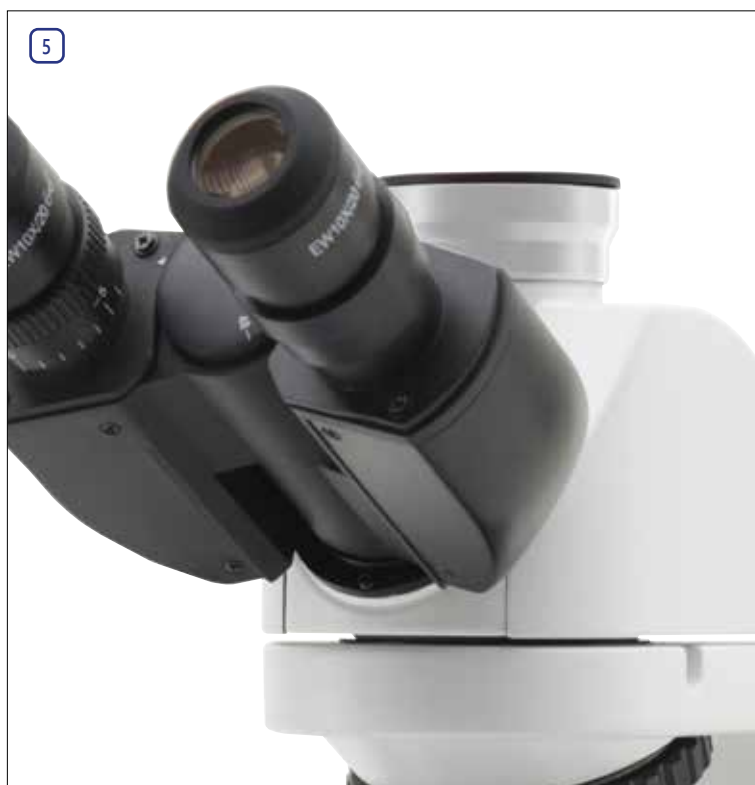
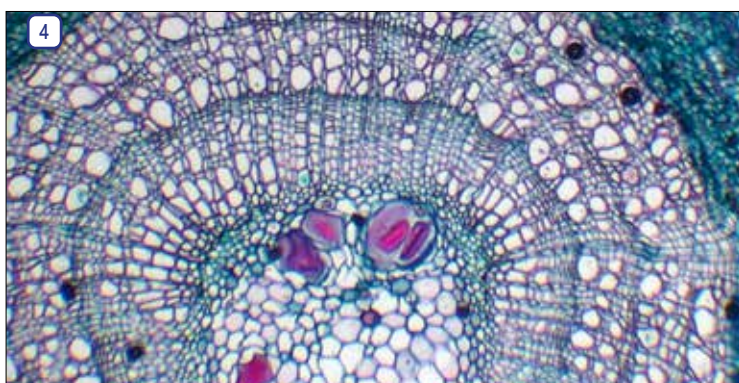
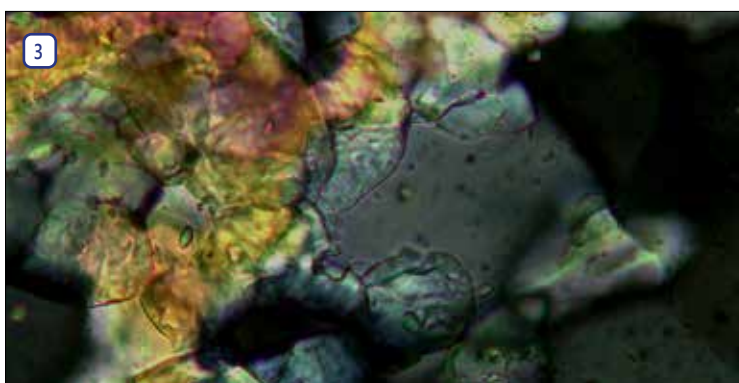



# Middle-Level Routine Lab Upright Microscopes

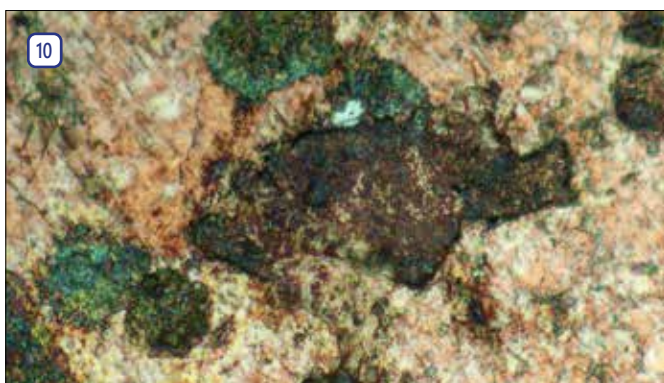
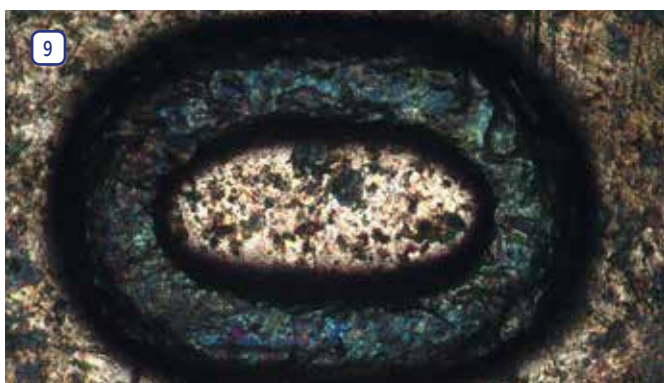

## B-380 Series - Brightfield Models

### B-382PL-ALC



Brightfield binocular microscope with N-PLAN objectives, rackless stage and combining the exclusive **X-LED<sup>3</sup>** with **ALC** (Automatic Light Control) for great-looking, rich and high-quality view.

- Observation mode:** Brightfield.
- Head:** Binocular, 30° inclined, 360° rotating (when ALC cable is unplugged).
- Interpupillary distance:** Adjustable between 48 and 75 mm.
- Dioptric adjustment:** On the left eyepiece tube.
- Eyepieces:** WF10x/20 mm, high eye-point and secured by screw.
- Nosepiece:** Quintuple revolving nosepiece, rotation on ball bearings.
- Objectives:**

N-PLAN 4x/0.10	N-PLAN 10x/0.25
N-PLAN 40x/0.65	N-PLAN 100x/1.25 (Oil/Water)

All with anti-fungus treatment.
- Specimen stage:** Double layer rackless mechanical stage, 150x139 mm, 75x33 mm X-Y range.
- Focusing:** Coaxial coarse (adjustable tension) and fine focusing mechanism with limit stop to prevent the contact between objective and specimen.
- Condenser:** Abbe N.A. 1.25, with objective-coded iris diaphragm, focusable and centerable.
- Illumination (Fixed Koehler type):** X-LED<sup>3</sup> with white 3.6 W LED (6,300K) and brightness control. **ALC** system.  
Multi-plug 100-240Vac/6Vdc external power supply.

### B-383PL



Brightfield trinocular microscope with N-PLAN objectives, rackless stage and the exclusive **X-LED<sup>3</sup>** for great-looking, rich and high-quality view.

- Observation mode:** Brightfield.
- Head:** Trinocular (fixed 50/50), 30° inclined, 360° rotating.
- Interpupillary distance:** Adjustable between 48 and 75 mm.
- Dioptric adjustment:** On the left eyepiece tube.
- Eyepieces:** WF10x/20 mm, high eye-point and secured by screw.
- Nosepiece:** Quintuple revolving nosepiece, rotation on ball bearings.
- Objectives:**

N-PLAN 4x/0.10	N-PLAN 10x/0.25
N-PLAN 40x/0.65	N-PLAN 100x/1.25 (Oil/Water)

All with anti-fungus treatment.
- Specimen stage:** Double layer rackless mechanical stage, 150x139 mm, 75x33 mm X-Y range.
- Focusing:** Coaxial coarse (adjustable tension) and fine focusing mechanism with limit stop to prevent the contact between objective and specimen.
- Condenser:** Abbe N.A. 1.25, with objective-coded iris diaphragm, focusable and centerable.
- Illumination (Fixed Koehler type):** X-LED<sup>3</sup> with white 3.6 W LED (6,300K) with brightness control.  
Multi-plug 100-240Vac/6Vdc external power supply.

# B-380 Series - Brightfield Models

2

Laboratory

## B-382PLi-ALC



Brightfield binocular microscope with IOS N-PLAN (Infinity Corrected) objectives, rackless stage and combining the exclusive **X-LED<sup>3</sup>** with **ALC** (Automatic Light Control) for great-looking, rich and high-quality view.

**Observation mode:** Brightfield.

**Head:** Binocular, 30° inclined, 360° rotating (when ALC cable is unplugged).

**Interpupillary distance:** Adjustable between 48 and 75 mm.

**Dioptric adjustment:** On the left eyepiece tube.

**Eyepieces:** WF10x/20 mm, high eye-point and secured by screw.

**Nosepiece:** Quintuple revolving nosepiece, rotation on ball bearings.

**Objectives:**

IOS N-PLAN 4x/0.10	IOS N-PLAN 10x/0.25
IOS N-PLAN 40x/0.65	IOS N-PLAN 100x/1.25 (Oil/Water)

All with anti-fungus treatment.

**Specimen stage:** Double layer rackless mechanical stage, 233x147 mm, 78x54 mm X-Y range.

**Focusing:** Coaxial coarse (adjustable tension) and fine focusing mechanism with limit stop to prevent the contact between objective and specimen.

**Condenser:** Abbe N.A. 1.25, with objective-coded iris diaphragm, focusable and centerable.

**Illumination (Fixed Koehler type):** X-LED<sup>3</sup> with white 3.6 W LED (6,300K) and brightness control. **ALC** system. Multi-plug 100-240Vac/6Vdc external power supply.

## B-383PLi



Brightfield trinocular microscope with IOS N-PLAN (Infinity Corrected) objectives, rackless stage and the exclusive **X-LED<sup>3</sup>** for great-looking, rich and high-quality view.

**Observation mode:** Brightfield.

**Head:** Trinocular (fixed 50/50), 30° inclined, 360° rotating.

**Interpupillary distance:** Adjustable between 48 and 75 mm.

**Dioptric adjustment:** On the left eyepiece tube.

**Eyepieces:** WF10x/20 mm, high eye-point and secured by screw.

**Nosepiece:** Quintuple revolving nosepiece, rotation on ball bearings.

**Objectives:**

IOS N-PLAN 4x/0.10	IOS N-PLAN 10x/0.25
IOS N-PLAN 40x/0.65	IOS N-PLAN 100x/1.25 (Oil/Water)

All with anti-fungus treatment.

**Specimen stage:** Double layer rackless mechanical stage, 233x147 mm, 78x54 mm X-Y range.

**Focusing:** Coaxial coarse (adjustable tension) and fine focusing mechanism with limit stop to prevent the contact between objective and specimen.

**Condenser:** Abbe N.A. 1.25, with objective-coded iris diaphragm, focusable and centerable.

**Illumination (Fixed Koehler type):** X-LED<sup>3</sup> with white 3.6 W LED (6,300K) with brightness control. Multi-plug 100-240Vac/6Vdc external power supply.

# B-380 Series - Phase Contrast Models

## B-382PH-ALC

-  20
- 
- 
- 
- 
- 
- 



Phase contrast, darkfield and brightfield binocular microscope with W-PLAN objectives, rackless stage and combining the exclusive **X-LED<sup>3</sup>** with **ALC** (Automatic Light Control) for great-looking, rich and high-quality view.

**Observation mode:** Brightfield, phase contrast and darkfield (dry).

**Head:** Binocular, 30° inclined, 360° rotating (when ALC cable is unplugged).

**Interpupillary distance:** Adjustable between 48 and 75 mm.

**Dioptric adjustment:** On the left eyepiece tube.

**Eyepieces:** WF10x/20 mm, high eye-point and secured by screw.

**Nosepiece:** Quintuple revolving nosepiece, rotation on ball bearings.

**Objectives:**  
 W-PLAN 4x/0.10                      W-PLAN PH 10x/0.25  
 W-PLAN PH 40x/0.65              W-PLAN PH 100x/1.25 (Oil/Water)  
 All with anti-fungus treatment.

**Specimen stage:** Double layer rackless mechanical stage, 150x139 mm, 75x33 mm X-Y range.

**Focusing:** Coaxial coarse (adjustable tension) and fine focusing mechanism with limit stop to prevent the contact between objective and specimen.

**Condenser:** Phase condenser (10x/20x, 40x, 100x) with darkfield (dry) and brightfield.

**Illumination (Fixed Koehler type):** X-LED<sup>3</sup> with white 3.6 W LED (6,300K) and brightness control. **ALC** system.  
 Multi-plug 100-240Vac/6Vdc external power supply.

## B-383PH

-  20
- 
- 
- 
- 
- 
- 



Phase contrast, darkfield and brightfield trinocular microscope with W-PLAN objectives, rackless stage and the exclusive **X-LED<sup>3</sup>** for great-looking, rich and high-quality view.

**Observation mode:** Brightfield, phase contrast and darkfield (dry).

**Head:** Trinocular (fixed 50/50), 30° inclined, 360° rotating.

**Interpupillary distance:** Adjustable between 48 and 75 mm.

**Dioptric adjustment:** On the left eyepiece tube.

**Eyepieces:** WF10x/20 mm, high eye-point and secured by screw.

**Nosepiece:** Quintuple revolving nosepiece, rotation on ball bearings.

**Objectives:**  
 W-PLAN 4x/0.10                      W-PLAN PH 10x/0.25  
 W-PLAN PH 40x/0.65              W-PLAN PH 100x/1.25 (Oil/Water)  
 All with anti-fungus treatment.

**Specimen stage:** Double layer rackless mechanical stage, 150x139 mm, 75x33 mm X-Y range.

**Focusing:** Coaxial coarse (adjustable tension) and fine focusing mechanism with limit stop to prevent the contact between objective and specimen.

**Condenser:** Phase condenser (10x/20x, 40x, 100x) with darkfield (dry) and brightfield.

**Illumination (Fixed Koehler type):** X-LED<sup>3</sup> with white 3.6 W LED (6,300K) with brightness control. Multi-plug 100-240Vac/6Vdc external power supply.

# B-380 Series - Phase Contrast Models

2

Laboratory

## B-382Phi-ALC



Phase contrast, darkfield and brightfield binocular microscope with IOS W-PLAN (Infinity Corrected) objectives, rackless stage and combining the exclusive **X-LED<sup>3</sup>** with **ALC** (Automatic Light Control) for great-looking, rich and high-quality view.

**Observation mode:** Brightfield, phase contrast and darkfield (dry).

**Head:** Binocular, 30° inclined, 360° rotating (when ALC cable is unplugged).

**Interpupillary distance:** Adjustable between 48 and 75 mm.

**Dioptric adjustment:** On the left eyepiece tube.

**Eyepieces:** WF10x/20 mm, high eye-point and secured by screw.

**Nosepiece:** Quintuple revolving nosepiece, rotation on ball bearings.

**Objectives:**

IOS W-PLAN PH 10x/0.25      IOS W-PLAN PH 20x/0.40  
IOS W-PLAN PH 40x/0.65      IOS W-PLAN PH 100x/1.25 (Oil)  
All with anti-fungus treatment.

**Specimen stage:** Double layer rackless mechanical stage, 233x147 mm, 78x54 mm X-Y range.

**Focusing:** Coaxial coarse (adjustable tension) and fine focusing mechanism with limit stop to prevent the contact between objective and specimen.

**Condenser:** Phase condenser (10x/20x, 40x, 100x) with darkfield (dry) and brightfield.

**Illumination (Fixed Koehler type):** X-LED<sup>3</sup> with white 3.6 W LED (6,300K) and brightness control. **ALC** system. Multi-plug 100-240Vac/6Vdc external power supply.

## B-383Phi



Phase contrast, darkfield and brightfield microscope with IOS W-PLAN (Infinity Corrected) objectives, rackless stage and the exclusive **X-LED<sup>3</sup>** for great-looking, rich and high-quality view.

**Observation mode:** Brightfield, phase contrast and darkfield (dry).

**Head:** (50/50), 30° inclined, 360° rotating.

**Interpupillary distance:** Adjustable between 48 and 75 mm.

**Dioptric adjustment:** On the left eyepiece tube.

**Eyepieces:** WF10x/20 mm, high eye-point and secured by screw.

**Nosepiece:** Quintuple revolving nosepiece, rotation on ball bearings.

**Objectives:**

IOS W-PLAN PH 10x/0.25      IOS W-PLAN PH 20x/0.40  
IOS W-PLAN PH 40x/0.65      IOS W-PLAN PH 100x/1.25 (Oil)  
All with anti-fungus treatment.

**Specimen stage:** Double layer rackless mechanical stage, 233x147 mm, 78x54 mm X-Y range.

**Focusing:** Coaxial coarse (adjustable tension) and fine focusing mechanism with limit stop to prevent the contact between objective and specimen.

**Condenser:** Phase condenser (10x/20x, 40x, 100x) with darkfield (dry) and brightfield.

**Illumination (Fixed Koehler type):** X-LED<sup>3</sup> with white 3.6 W LED (6,300K) with brightness control. Multi-plug 100-240Vac/6Vdc external power supply.

# B-383DK - Darkfield Microscope

Laboratory upright microscope for brightfield and darkfield observations with N-PLAN objectives (and W-PLAN 100x with iris) for biology and especially darkfield fresh blood analysis and the exclusive **X-LED<sup>3</sup>** illumination system. The special condenser with integrated, exclusive X-LED3 illuminator replaces any other external and expensive lighting source required for these applications and is ideal for great-looking, rich and high-quality specimen view. Our immersion darkfield system provides the same result achieved by 150W external illuminators in combination with traditional cardioid darkfield condenser.

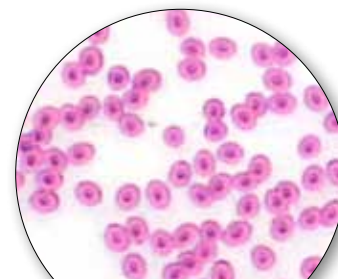

10x

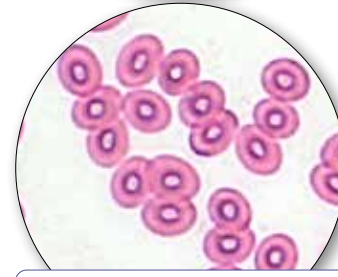

40x

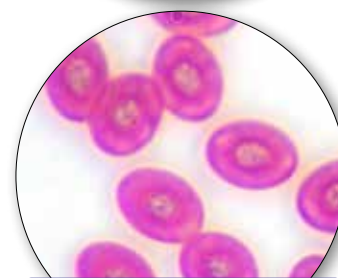

100x Brightfield

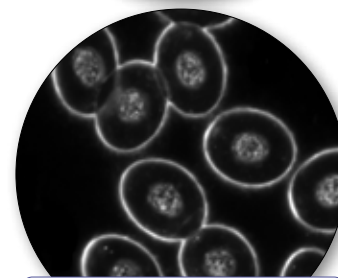

100x Darkfield

Part	Description
<b>Observation mode:</b>	Brightfield, oil immersion darkfield.
<b>Head:</b>	Trinocular (fixed 50/50), 30° inclined, 360° rotating.
<b>Interpupillary distance:</b>	Adjustable between 48 and 75 mm.
<b>Dioptric adjustment:</b>	On the left eyepiece tube.
<b>Eyepieces:</b>	WF10x/20 mm, high eye-point and secured by screw.
<b>Nosepiece</b>	Quintuple revolving nosepiece, rotation on ball bearings.
<b>Objectives:</b>	N-PLAN 4x/0.10 N-PLAN 10x/0.25 N-PLAN 40x/0.65 W-PLAN 100x/1.25 (oil) with iris All with anti-fungus treatment.

Part	Description
<b>Specimen stage:</b>	Double layer rackless mechanical stage, 150x139 mm, 75x33 mm X-Y range.
<b>Focusing:</b>	Coaxial coarse (adjustable tension) and fine focusing mechanism with limit stop to prevent the contact between objective and specimen.
<b>Brightfield condenser:</b>	Abbe N.A. 1.25, with objective-coded iris diaphragm, focusable and centerable.
<b>Darkfieldfield condenser:</b>	Darkfield N.A. 1.36 (oil immersion) with built-in X-LED <sup>3</sup> .
<b>Transmitted illumination (Fixed Koehler type):</b>	X-LED <sup>3</sup> with white 3.6 W LED (6,300K) with brightness control. Multi-plug 100-240Vac/6Vdc external power supply.

# B-383FL - HBO Fluorescence Microscope

Laboratory upright microscope for brightfield and fluorescence observations with IOS N-PLAN objectives.

The HBO fluorescence illuminator provides an outstanding flexibility of use, standing the blue and green filter sets (supplied as standard) for Auramine, FITC, GFP and YFP (with blue filter set) plus Rhodamine, Texas Red and TRITC (with the green one), yet giving the possibility to combine any other specific filter sets for future upgrade. Transmitted light through the exclusive **X-LED<sup>3</sup>** to ensure great-looking, rich and high-quality specimen view.

-  20
- 
- 
-  X-LED<sup>3</sup>
-  IOS ∞
-  N-PLAN
-  100x WATER
-  FL

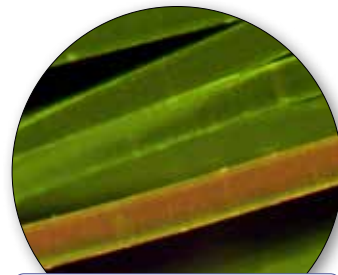

10x - Blue excitation

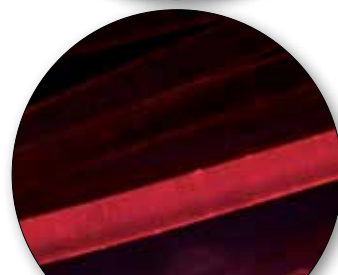

10x - Green excitation

### Standard filterset

Name	Excitation filter (nm)	Dichroic mirror cut-off (nm)	Emission filter (nm)
B Blue	460 – 490	505	515LP
G Green	510 – 550	570	575LP



Part	Description
<b>Observation mode:</b>	Brightfield, HBO fluorescence.
<b>Epi-illumination and filters:</b>	HBO 100 W high pressure mercury lamp. 3-position filter holder; blue and green included.
<b>Head:</b>	Trinocular (fixed 50/50), 30° inclined, 360° rotating.
<b>Interpupillary distance:</b>	Adjustable between 48 and 75 mm.
<b>Dioptric adjustment:</b>	On the left eyepiece tube.
<b>Eyepieces:</b>	WF10x/20 mm, high eye-point and secured by screw.
<b>Nosepiece:</b>	Quintuple revolving nosepiece, rotation on ball bearings.
<b>Objectives:</b>	IOS N-PLAN 4x/0.10      IOS N-PLAN 10x/0.25 IOS N-PLAN 20x/0.40    IOS N-PLAN 40x/0.65 IOS N-PLAN 100x/1.25 (Oil/Water) All with anti-fungus treatment.

Part	Description
<b>Specimen stage:</b>	Double layer rackless mechanical stage, 233x147 mm, 78x54 mm X-Y range.
<b>Focusing:</b>	Coaxial coarse (adjustable tension) and fine focusing mechanism with limit stop to prevent the contact between objective and specimen.
<b>Condenser:</b>	Abbe N.A. 1.25, with objective-coded iris diaphragm, focusable and centerable.
<b>Transmitted illumination (Fixed Koehler type):</b>	X-LED <sup>3</sup> with white 3.6 W LED (6,300K) with brightness control. Multi-plug 100-240Vac/6Vdc external power supply.

# B-383LD1 - LED Fluorescence Microscope

Entry-level laboratory upright microscope for brightfield and fluorescence observations with IOS N-PLAN objectives. The extremely powerful LED fluorescence illuminator is combined with blue excitation filter set for the visualization of the following fluorochromes: Acridine Yellow, Acridine Orange, Auramine, DiO, DTAF, FITC, GFP, YFP, etc. LED fluorescence ensures unparalleled convenience eliminating warm-up/cool-down times and all the inconveniences related lamp replacement and adjustment. Transmitted light through the exclusive **X-LED<sup>3</sup>** to ensure great-looking, rich and high-quality specimen view.



4x

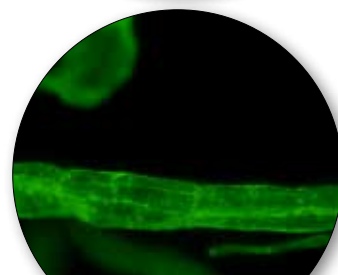

10x

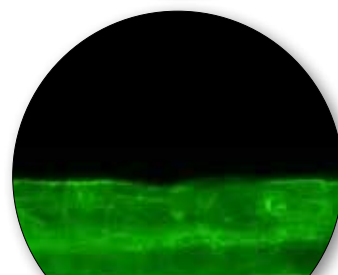

20x

## Standard filterset

Name	Excitation filter (nm)	Dichroic mirror cut-off (nm)	Emission filter (nm)
B Blue	460 – 490	505	515LP

Part	Description
<b>Observation mode:</b>	Brightfield, LED fluorescence.
<b>Epi-illumination and filter:</b>	High-power blue LED with brightness control. 3-position filter holder; blue included.
<b>Head:</b>	Trinocular (fixed 50/50), 30° inclined, 360° rotating.
<b>Interpupillary distance:</b>	Adjustable between 48 and 75 mm.
<b>Dioptric adjustment:</b>	On the left eyepiece tube.
<b>Eyepieces:</b>	WF10x/20 mm, high eye-point and secured by screw.
<b>Nosepiece:</b>	Quintuple revolving nosepiece, rotation on ball bearings.
<b>Objectives:</b>	IOS N-PLAN 4x/0.10      IOS N-PLAN 10x/0.25 IOS N-PLAN 20x/0.40      IOS N-PLAN 40x/0.65 IOS N-PLAN 100x/1.25 (Oil/Water) All with anti-fungus treatment.

Part	Description
<b>Specimen stage:</b>	Double layer rackless mechanical stage, 233x147 mm, 78x54 mm X-Y range.
<b>Focusing:</b>	Coaxial coarse (adjustable tension) and fine focusing mechanism with limit stop to prevent the contact between objective and specimen.
<b>Condenser:</b>	Abbe N.A. 1.25, with objective-coded iris diaphragm, focusable and centerable.
<b>Transmitted illumination (Fixed Koehler type):</b>	X-LED <sup>3</sup> with white 3.6 W LED (6,300K) with brightness control. Multi-plug 100-240Vac/6Vdc external power supply.



# B-383LD2 - LED Fluorescence Microscope

Laboratory upright microscope for brightfield and fluorescence observations with IOS N-PLAN objectives. The extremely powerful LED fluorescence illuminator is combined with blue and green excitation filter set for the visualization of the following fluorochromes: Acridine Yellow, Acridine Orange, Auramine, DiO, DTAF, FITC, GFP, YFP, etc. (blue) plus Rhodamine, Texas Red and TRITC (green). LED fluorescence ensures unparalleled convenience eliminating warm-up/cool-down times and all the inconveniences related lamp replacement and adjustment. Transmitted light through the exclusive **X-LED<sup>3</sup>** to ensure great-looking, rich and high-quality specimen view.

-  20
- 
- 
-  X-LED<sup>3</sup>
- 
-  IOS ∞
-  N-PLAN
-  WATER
-  FL



4x



10x

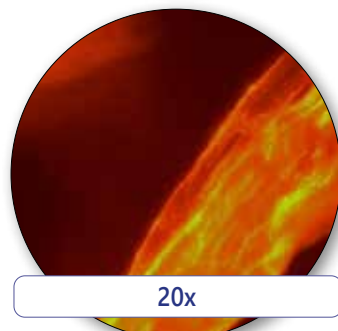

20x

## Standard filterset

Name	Excitation filter (nm)	Dichroic mirror cut-off (nm)	Emission filter (nm)
B Blue	460 - 490	505	515LP
G Green	510 - 550	570	575LP

Part	Description
<b>Observation mode:</b>	Brightfield, LED fluorescence.
<b>Epi-illumination and filters:</b>	High-power wide spectrum LED with brightness control. 3-position filter holder; blue and green included.
<b>Head:</b>	Trinocular (fixed 50/50), 30° inclined, 360° rotating.
<b>Interpupillary distance:</b>	Adjustable between 48 and 75 mm.
<b>Dioptric adjustment:</b>	On the left eyepiece tube.
<b>Eyepieces:</b>	WF10x/20 mm, high eye-point and secured by screw.
<b>Nosepiece:</b>	Quintuple revolving nosepiece, rotation on ball bearings.
<b>Objectives:</b>	IOS N-PLAN 4x/0.10      IOS N-PLAN 10x/0.25 IOS N-PLAN 20x/0.40    IOS N-PLAN 40x/0.65 IOS N-PLAN 100x/1.25 (Oil/Water) All with anti-fungus treatment.

Part	Description
<b>Specimen stage:</b>	Double layer rackless mechanical stage, 233x147 mm, 78x54 mm X-Y range.
<b>Focusing:</b>	Coaxial coarse (adjustable tension) and fine focusing mechanism with limit stop to prevent the contact between objective and specimen.
<b>Condenser:</b>	Abbe N.A. 1.25, with objective-coded iris diaphragm, focusable and centerable.
<b>Transmitted illumination (Fixed Koehler type):</b>	X-LED <sup>3</sup> with white 3.6 W LED (6,300K) with brightness control. Multi-plug 100-240Vac/6Vdc external power supply.

# B-383POL - Polarizing Microscope

Upright microscope for brightfield and polarizing light observations with strain-free IOS N-PLAN POL objectives. Complete of polarizer and analyzer filters, Bertrand lens for conoscopic observation, compensator plates and high-precision rotatable stages. It comes with the exclusive **X-LED<sup>3</sup>** illumination system to deliver bright and clear images, along with all the accessories to perform accurate polarization analysis in biology and materials science.



4x with First Order plate

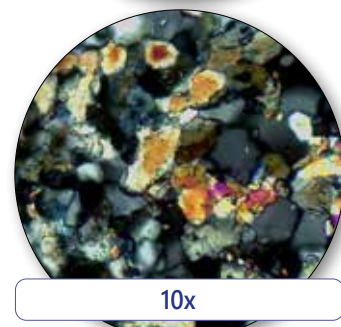

10x



10x with First Order plate

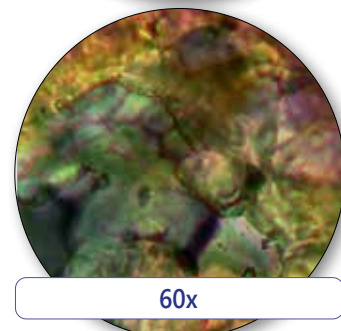

60x

Part	Description
<b>Observation mode:</b>	Brightfield, transmitted polarized light and conoscopy.
<b>Bertrand lens and polarizing attachment:</b>	Swing-out type with centering mechanism for observation in conoscopy/orthoscopy. Rotatable analyzer from 0° to 90° with graduated scale. Tint plates: 1° order red ( $\lambda$ ); $\lambda/4$ ; Quartz wedge.
<b>Head:</b>	Trinocular (fixed 50/50), 30° inclined, 360° rotating.
<b>Interpupillary distance:</b>	Adjustable between 48 and 75 mm.
<b>Dioptric adjustment:</b>	On the left eyepiece tube.
<b>Eyepieces:</b>	WF10x/20 mm, high eye-point and secured by screw. One with crosshair.
<b>Nosepiece:</b>	Quadruple revolving nosepiece, rotation on ball bearings. Centering system for each objective.

Part	Description
<b>Objectives (strain-free):</b>	IOS N-PLAN POL 4x/0.10 IOS N-PLAN POL 10x/0.25 IOS N-PLAN POL 40x/0.65 IOS N-PLAN POL 60x/0.80 All with anti-fungus treatment.
<b>Specimen stage:</b>	Rotatable stage with locking mechanism. Vernier scale with accuracy 0.1 mm. Diameter 160 mm. Specimen slide clamps.
<b>Focusing:</b>	Coaxial coarse (adjustable tension) and fine focusing mechanism with limit stop to prevent the contact between objective and specimen.
<b>Condenser:</b>	Abbe N.A. 1.25, with objective-coded iris diaphragm, focusable and centerable. With rotating polarizing filter.
<b>Transmitted illumination (Fixed Koehler type):</b>	X-LED <sup>3</sup> with white 3.6 W LED (6.300 K) with brightness control. Multi-plug 100-240Vac/6Vdc external power supply.

# B-383MET - Metallurgical Microscope

Brightfield upright microscope with IOS W-PLAN MET objectives and metallurgical attachment combining the exclusive **X-LED<sup>3</sup>** lighting source both for incident and transmitted illumination. The NCG (no cover glass) objectives are especially designed for microscopy use without a cover slip ideal for metallographic samples and other opaque specimens.

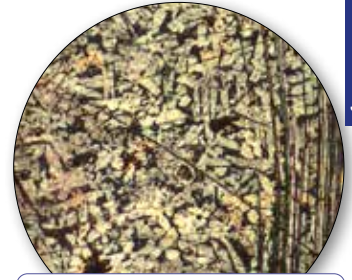

5x

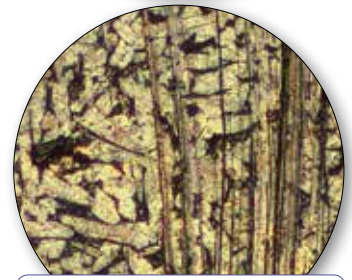

10x

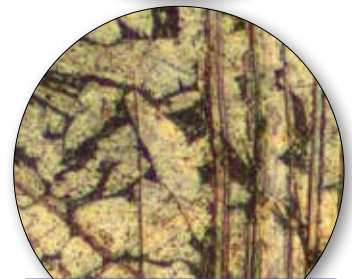

20x

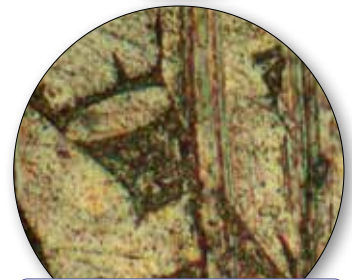

50x

Part	Description
<b>Observation mode:</b>	Brightfield, incident polarized light.
<b>Epi-illumination and polarizing filters:</b>	X-LED <sup>3</sup> with white 3.6 W LED (6.300 K) with brightness control. Field and aperture diaphragms, polarizer & analyzer filters.
<b>Head:</b>	Trinocular (fixed 50/50), 30° inclined, 360° rotating.
<b>Interpupillary distance:</b>	Adjustable between 48 and 75 mm.
<b>Dioptric adjustment:</b>	On the left eyepiece tube.
<b>Eyepieces:</b>	WF10x/20 mm, high eye-point and secured by screw.
<b>Nosepiece:</b>	Quintuple revolving nosepiece, rotation on ball bearings.

Part	Description
<b>Objectives (strain-free):</b>	IOS W-PLAN MET 5x/0.12 IOS W-PLAN MET 10x/0.25 IOS W-PLAN MET 20x/0.40 IOS W-PLAN MET 50x/0.75 All with anti-fungus treatment.
<b>Specimen stage:</b>	Double layer rackless mechanical stage, 233x147 mm, 78x54 mm X-Y range. With tempered glass plate.
<b>Focusing:</b>	Coaxial coarse (adjustable tension) and fine focusing mechanism with limit stop to prevent the contact between objective and specimen.
<b>Condenser:</b>	Abbe N.A. 1.25, with objective-coded iris diaphragm, focusable and centerable.
<b>Transmitted illumination (Fixed Koehler type):</b>	X-LED <sup>3</sup> with white 3.6 W LED (6.300 K) with brightness control. Multi-plug 100-240Vac/6Vdc external power supply.

# B-380 Series - Comparison chart

Model	Head	Eyepieces	Nosepiece	Objectives	Stage	Focusing	Condenser	illumination
<b>B-382PL-ALC</b>	Binocular, 30° inclined	WF 10x/20	Quintuple, reversed	N-PLAN 4x, 10x, 40x, 100x (oil/water)	Rackless double layer, 150x139mm, moving range 75x33mm	Coaxial coarse and fine, limit stop, adjustable tension	Abbe N.A. 1.25, iris diaphragm, focusable and centrable	3.6 W X-LED <sup>3</sup> , brightness control, ALC control. Fixed Koehler
<b>B-383PL</b>	Trinocular, 30° inclined, 360° rotating	WF 10x/20	Quintuple, reversed	N-PLAN 4x, 10x, 40x, 100x (oil/water)	Rackless double layer, 150x139mm, moving range 75x33mm	Coaxial coarse and fine, limit stop, adjustable tension	Abbe N.A. 1.25, iris diaphragm, focusable and centrable	3.6 W X-LED <sup>3</sup> , brightness control. Fixed Koehler
<b>B-382PLi-ALC</b>	Binocular, 30° inclined	WF 10x/20	Quintuple, reversed	IOS N-PLAN 4x, 10x, 40x, 100x (oil/water)	Rackless double layer, 233x147mm, moving range 78x54 mm	Coaxial coarse and fine, limit stop, adjustable tension	Abbe N.A. 1.25, iris diaphragm, focusable and centrable	3.6 W X-LED <sup>3</sup> , brightness control, ALC control. Fixed Koehler
<b>B-383PLi</b>	Trinocular, 30° inclined, 360° rotating	WF 10x/20	Quintuple, reversed	IOS N-PLAN 4x, 10x, 40x, 100x (oil/water)	Rackless double layer, 233x147mm, moving range 78x54 mm	Coaxial coarse and fine, limit stop, adjustable tension	Abbe N.A. 1.25, iris diaphragm, focusable and centrable	3.6 W X-LED <sup>3</sup> , brightness control. Fixed Koehler
<b>B-382PH-ALC</b>	Binocular, 30° inclined	WF 10x/20	Quintuple, reversed	W-PLAN 4x, 10xPH, 40xPH, 100xPH (oil)	Rackless double layer, 150x139mm, moving range 75x33mm	Coaxial coarse and fine, limit stop, adjustable tension	Phase condenser (10x/20x, 40x, 100x) with darkfield (dry) and brightfield	3.6 W X-LED <sup>3</sup> , brightness control, ALC control. Fixed Koehler
<b>B-383PH</b>	Trinocular, 30° inclined, 360° rotating	WF 10x/20	Quintuple, reversed	W-PLAN 4x, 10xPH, 40xPH, 100xPH (oil)	Rackless double layer, 150x139mm, moving range 75x33mm	Coaxial coarse and fine, limit stop, adjustable tension	Phase condenser (10x/20x, 40x, 100x) with darkfield (dry) and brightfield	3.6 W X-LED <sup>3</sup> , brightness control. Fixed Koehler
<b>B-382PHi-ALC</b>	Binocular, 30° inclined	WF 10x/20	Quintuple, reversed	IOS W-PLAN 10xPH, 20xPH, 40xPH, 100xPH (oil)	Rackless double layer, 233x147mm, moving range 78x54 mm	Coaxial coarse and fine, limit stop, adjustable tension	Phase condenser (10x/20x, 40x, 100x) with darkfield (dry) and brightfield	3.6 W X-LED <sup>3</sup> , brightness control, ALC control. Fixed Koehler
<b>B-383PHi</b>	Trinocular, 30° inclined, 360° rotating	WF 10x/20	Quintuple, reversed	IOS W-PLAN 10xPH, 20xPH, 40xPH, 100xPH (oil)	Rackless double layer, 233x147mm, moving range 78x54 mm	Coaxial coarse and fine, limit stop, adjustable tension	Phase condenser (10x/20x, 40x, 100x) with darkfield (dry) and brightfield	3.6 W X-LED <sup>3</sup> , brightness control. Fixed Koehler
<b>B-383DK</b>	Trinocular, 30° inclined, 360° rotating	WF 10x/20	Quintuple, reversed	N-PLAN 4x, 10x, 40x, W-PLAN 100x (oil, with iris diaphragm)	Rackless double layer, 150x139mm, moving range 75x33mm	Coaxial coarse and fine, limit stop, adjustable tension	Abbe N.A. 1.25, iris diaphragm, focusable and centrable. Additional darkfield condenser, N.A. 1.36, built-in X-LED <sup>3</sup>	3.6 W X-LED <sup>3</sup> , brightness control. Fixed Koehler
<b>B-383FL</b>	Trinocular, 30° inclined, 360° rotating	WF 10x/20	Quintuple, reversed	IOS N-PLAN 4x, 10x, 20x, 40x, 100x (oil/water)	Rackless double layer, 233x147mm, moving range 78x54 mm	Coaxial coarse and fine, limit stop, adjustable tension	Abbe N.A. 1.25, iris diaphragm, focusable and centrable	<b>Transmitted:</b> 3.6 W X-LED <sup>3</sup> , brightness control. Fixed Koehler <b>Incident:</b> HBO 100 W high-pressure mercury bulb
<b>B-383LD1</b>	Trinocular, 30° inclined, 360° rotating	WF 10x/20	Quintuple, reversed	IOS N-PLAN 4x, 10x, 20x, 40x, 100x (oil/water)	Rackless double layer, 233x147mm, moving range 78x54 mm	Coaxial coarse and fine, limit stop, adjustable tension	Abbe N.A. 1.25, iris diaphragm, focusable and centrable	<b>Transmitted:</b> 3.6 W X-LED <sup>3</sup> , brightness control. Fixed Koehler <b>Incident:</b> High-power blue LED
<b>B-383LD2</b>	Trinocular, 30° inclined, 360° rotating	WF 10x/20	Quintuple, reversed	IOS N-PLAN 4x, 10x, 20x, 40x, 100x (oil/water)	Rackless double layer, 233x147mm, moving range 78x54 mm	Coaxial coarse and fine, limit stop, adjustable tension	Abbe N.A. 1.25, iris diaphragm, focusable and centrable	<b>Transmitted:</b> 3.6 W X-LED <sup>3</sup> , brightness control. Fixed Koehler <b>Incident:</b> High-power wide spectrum LED
<b>B-383POL</b>	Trinocular, 30° inclined, 360° rotating	WF 10x/20 (one with crosshair reticle)	Quadruple, reversed	Strain-free IOS N-PLAN POL 4x, 10x, 40x, 60x	Round, 360° rotating, 160mm diameter, with sample clips and stop knob	Coaxial coarse and fine, limit stop, adjustable tension	Abbe N.A. 1.25, iris diaphragm, focusable and centrable. With rotating polarizer	3.6 W X-LED <sup>3</sup> , brightness control. Fixed Koehler
<b>B-383MET</b>	Trinocular, 30° inclined, 360° rotating	WF 10x/20	Quintuple, reversed	IOS W-PLAN MET 5x, 10x, 20x, 50x	Rackless double layer, 233x147mm, moving range 78x54 mm	Coaxial coarse and fine, limit stop, adjustable tension	Abbe N.A. 1.25, iris diaphragm, focusable and centrable	<b>Transmitted and incident:</b> 3.6 W X-LED <sup>3</sup> , brightness control. Fixed Koehler

# B-380 Series - Accessories

## Eyecups & Eyepieces

- M-001 Huygens 5x eyepiece
- M-008.1 WF10x/20 eyepiece, high eyepoint, with pointer, rubber cup
- M-160 EW10x/20 eyepiece, high eyepoint, with rubber cup
- M-161 EW15x/16 eyepiece, with rubber cup
- M-162 WF20x/10 eyepiece
- M-163 EW10x/20 micrometric eyepiece, high eyepoint, with rubber cup

## Objectives & Additional Lenses

### N-PLAN

- M-164 N-PLAN objective 4x/0.10
- M-165 N-PLAN objective 10x/0.25
- M-166 N-PLAN objective 20x/0.40
- M-167 N-PLAN objective 40x/0.65
- M-168 N-PLAN objective 60x/0.85
- M-169 N-PLAN objective 100x/1.25 (oil)

### IOS N-PLAN

- M-144 IOS N-PLAN objective 4x/0.10
- M-145 IOS N-PLAN objective 10x/0.25
- M-146 IOS N-PLAN objective 20x/0.40
- M-147 IOS N-PLAN objective 40x/0.65
- M-149 IOS N-PLAN objective 60x/0.80
- M-148 IOS N-PLAN objective 100x/1.25 (oil)
- M-144P IOS N-PLAN POL objective 4x/0.10
- M-145P IOS N-PLAN POL objective 10x/0.25
- M-146P IOS N-PLAN POL objective 20x/0.40
- M-147P IOS N-PLAN POL objective 40x/0.65
- M-149P IOS N-PLAN POL objective 60x/0.80
- M-148P IOS N-PLAN POL objective 100x/1.25 (oil)

### W-PLAN

- M-059 W-PLAN objective 100x/1.25OI - (oil) objective with iris for DF
- M-170 W-PLAN PH objective 10x/0.25
- M-171 W-PLAN PH objective 20x/0.40
- M-172 W-PLAN PH objective 40x/0.65
- M-182 W-PLAN PH objective 100x/1.25 (oil)

### IOS W-PLAN

- M-634.1 IOS W-PLAN objective 50x/0.95 (oil)
- M-336 IOS W-PLAN MET objective 5x/0.12
- M-338 IOS W-PLAN MET objective 10x/0.25
- M-339 IOS W-PLAN MET objective 20x/0.40
- M-335 IOS W-PLAN MET objective 50x/0.75
- M-698.2 IOS W-PLAN MET objective 100x/0.80 (dry)
- M-1120.N IOS W-PLAN PH objective 10x/0.25
- M-1121.N IOS W-PLAN PH objective 20x/0.40
- M-1122.N IOS W-PLAN PH objective 40x/0.65
- M-1123.N IOS W-PLAN PH objective 100x/1.25 (oil)

- M-179 PH set - 10x, 40x, 100x W-PLAN PH obj. & BF/DF/PH condenser

More accessories on the next page



**M-179** - PH set - 10x, 40x, 100x W-PLAN PH obj. & BF/DF/PH condenser



**M-185** - Darkfield condenser for dry objectives

# B-380 Series - Accessories

## Stages

M-175	Rotating stage for polarising set (for 150x139mm rackless stage)
M-175.1	Rotating stage for polarising set (for 233x147mm rackless stage)
M-635-EU	Heating stage (on newly purchased microscopes, for 233x147mm), EU
M-635-UK	Heating stage (on newly purchased microscopes, for 233x147mm), UK
M-635-US	Heating stage (on newly purchased microscopes, for 233x147mm), US
M-635-SW	Heating stage (on newly purchased microscopes, for 233x147mm), CH
M-666.290-EU	Applicable heating stage (for 150x139mm rackless stage), EU
M-666.290-UK	Applicable heating stage (for 150x139mm rackless stage), UK
M-666.290-US	Applicable heating stage (for 150x139mm rackless stage), US
M-666.290-CH	Applicable heating stage (for 150x139mm rackless stage), CH

## Condensers & Filters

M-174.1	Polarising set (filters only) (except for B-383POL)
M-185	Darkfield condenser for dry objectives
M-975.1	Ring with blue filter, 45mm diameter
M-977.1	Ring with green filter, 45mm diameter
M-979.1	Ring with yellow filter, 45mm diameter
M-989.1	Ring with frosted glass filter, 45mm diameter

## Camera Adapters

M-115	0.35x C-Mount projection lens
M-114	0.5x C-Mount projection lens
M-118	0.75x C-Mount projection lens
M-173	C-Mount projection lens for APS-C/full frame reflex cameras (trino)
M-620	0.35x focusable C-Mount adapter (biological microscopes)
M-620.1	0.5x focusable C-Mount adapter (biological microscopes)
M-620.2	0.65x focusable C-Mount adapter (biological microscopes)
M-620.3	1x focusable C-Mount adapter (biological & stereomicroscopes)
M-699	Universal adapter for C-Mount projection lens (trino)

## Miscellaneous

15008	Immersion oil, 10ml
15009	Immersion oil, 100ml
15104	Cleaning kit
DC-002	Plastic dust cover, medium, 490(l)x490(h) mm (except for B-383POL, B-383MET, B-383LD1, B-383LD2 and B-383FL)
DC-003	TNT dust cover, medium, 600(l)x550(h) mm (only for B-383POL, B-383MET, B-383LD1, B-383LD2 and B-383FL)
M-005	Micrometric slide, 26x76mm, with 2 scales (1mm/100 & 10mm/100)
M-069	Solar charger
M-151	HBO 100W high-pressure mercury bulb for fluorescence (only for B-383FL)
M-151.1	HBO 100W high-pressure mercury bulb for fluorescence (OSRAM) (only for B-383FL)
M-156	Koehler field diaphragm (on newly purchased microscopes) (except for B-383POL)
M-1380	Centering telescope, 23mm diameter
VP-380	IQ/OQ/PQ manual for B-380 series



### How to connect the cameras to our microscopes.

Please refer to the Adapter reference list on Digital section.

### 15104 - Cleaning kit

It cleans glass quickly and effectively, without leaving residue or odor. Ideal for precision lens or prism cleaning.



### M-069 - Solar charger

Included battery: rechargeable – Lithium-Poly. Capacity: 2600 mAh. Output voltage: 5.5Vdc. - Dimensions: 120x73x10 mm. Autonomy: over 6 hours at medium intensity (X-LED<sup>3</sup>). Charging modes: with solar panel (12h), with external USB power supply (not included) or from PC USB port (5h).



v 1.4.0 - OPTIKA reserves the right to make corrections, modifications, enhancements, improvements and other changes to its products at any time without notice.

## Headquarters and Manufacturing Facilities

**OPTIKA® S.r.l.** Via Rigla, 30 - 24010 Ponteranica (BG) - ITALY - Tel: +39 035.571.392 - info@optikamicroscopes.com

## Optika Sales branches

**OPTIKA® Spain** spain@optikamicroscopes.com  
**OPTIKA® China** china@optikamicroscopes.com  
**OPTIKA® India** india@optikamicroscopes.com

**OPTIKA® USA** usa@optikamicroscopes.com  
**OPTIKA® Central America** camerica@optikamicroscopes.com

## B-510 Series



**Advanced Routine Lab Upright Microscopes**

# Born To Be Professional

## HIGH-GRADE CONFIGURATIONS FOR PROFESSIONALS

- » Wide range to fulfil specific lab requirements
- » Valuable solutions for life and material sciences
- » Compliant with several observation methods

## AN AFFORDABLE PARTNER WITH HIGH-END FEATURES

- » IOS W-PLAN objectives for flat images on 22 mm FN
- » Full Koehler illumination for enhanced images
- » Rounded edge, rackless stage to prevent scratches

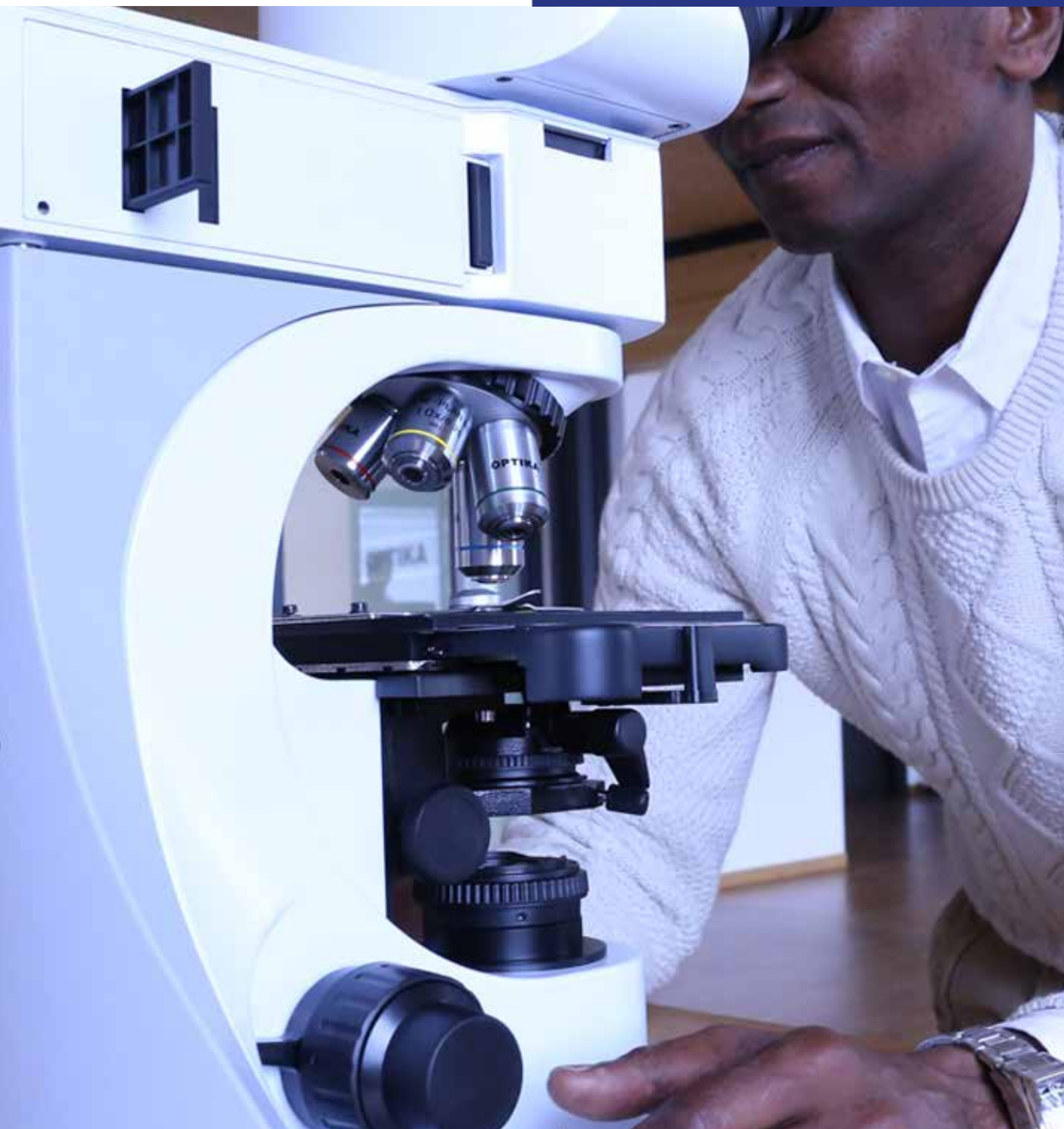



# Optically Impressive

## MAINTAINING GOOD EYESIGHT

- » 10x/22 eyepieces for large specimen view
- » Comfortable rubber cup to get rid of annoying external light
- » High eye-point for glasses wearers, dioptic adjustment (left eyepiece)

## B-510 & IOS W-PLAN: THE PERFECT COMBINATION

- » IOS Infinity corrected optical system
- » Full planarity optics on 22 mm (W-PLAN) according to ISO 19012-1
- » High-grade Semi-Apo lens available ideal for fluorescence



# An Extensive Range of Different Configurations

## THE MODELS FOR ASBESTOS TESTING IN ENVIRONMENTAL MONITORING

- » B-510ASB measures fiber concentrations in air and includes 40xPH lens and 12.5x Walton & Beckett eyepieces
- » B-510POL & B-510POL-I for bulk/fiber class identification

## B-510DK - THE DEDICATED MODEL FOR FRESH BLOOD ANALYSIS

- » Exclusive X-LED<sup>3</sup> darkfield cardioid condenser with high N.A. 1.36 and the new IOS W-PLAN 100x oil iris objective
- » Brightfield condenser also supplied

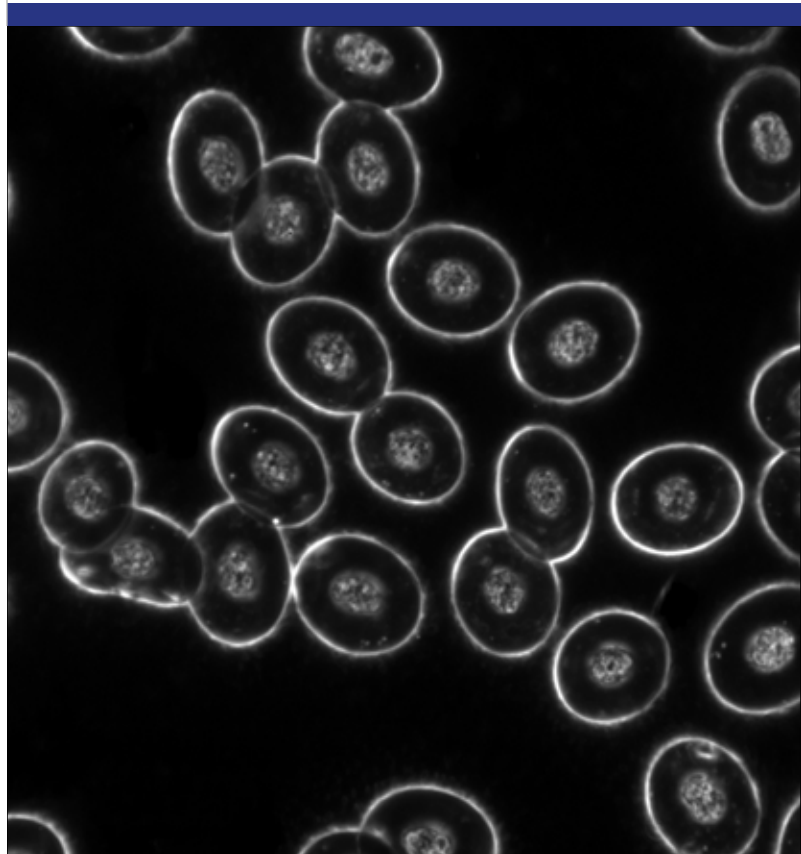
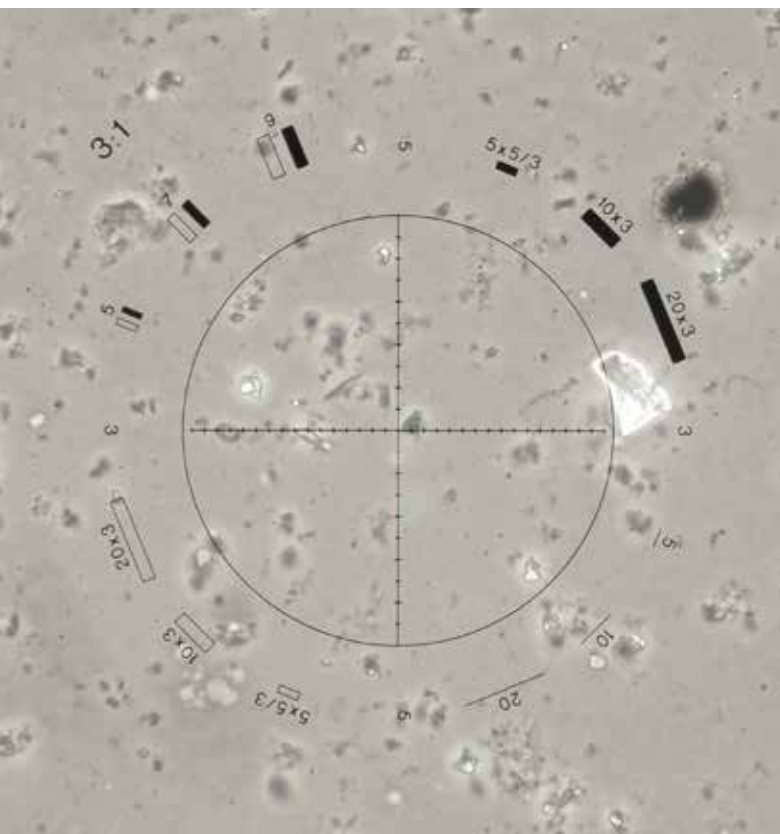

## Multiple Observation Methods

**BRIGHTFIELD**

**METALLOGRAPHY**

**DARKFIELD**

**POLARIZATION**

**FLUORESCENCE**

**PHASE CONTRAST**

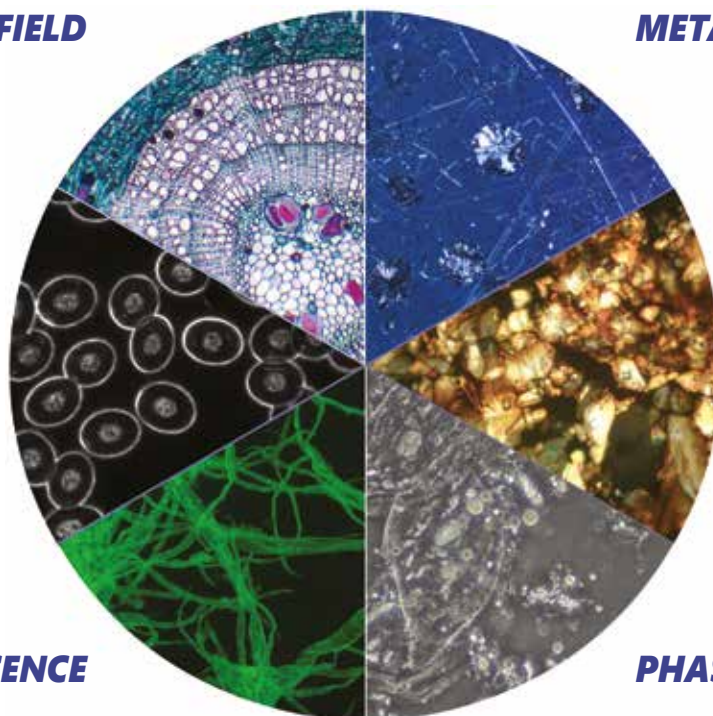

# Many Specimens, Many Observers - Intense Productivity

2

## INCREASE YOUR SAMPLE THROUGHPUT

- » Large, resistant stage to easily and quickly process 2 samples
- » Ergonomic design and controls for extended operation
- » Convenient handle for easy transportation

## DISCUSSION BRIDGES FOR SIMULTANEOUS OBSERVATIONS AND TEACHING

- » RGB pointer with brightness adjustment for the main observer
- » Face-to-face attachment with 1 extra viewing head, 20mm FN
- » Side attachment with 1, 2 & 4 extra viewing heads, 20mm FN

Laboratory



### **Multi-Head Discussion Microscopes**

With discussion bridges, up to 5 people/colleagues can observe the same image on B-510. Ideal for teaching and training students, especially in the medical field. The main observer and additional viewers will benefit of an extremely homogeneous light conditions, with a three-colour pointer with settable intensity to highlight points of interest.

# X-LED<sup>3</sup> - Only Available at OPTIKA

## STATE-OF-THE-ART ILLUMINATION SYSTEM

- » Uncomparable light intensity, exclusive lens & collector design
- » Constant pure-white color temperature at all intensity levels
- » Unmatched color fidelity, uniformity and brightness

## CUT ELECTRICITY BILLS BY 90%

- » Money & energy saving, only 3.6 W
- » More efficient brightness than a 50 W halogen lamp
- » LED long lifetime (65,000 hours = 22 years at 8 hours/day usage)

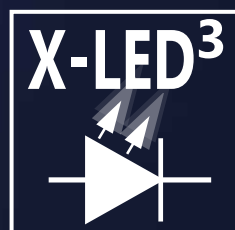
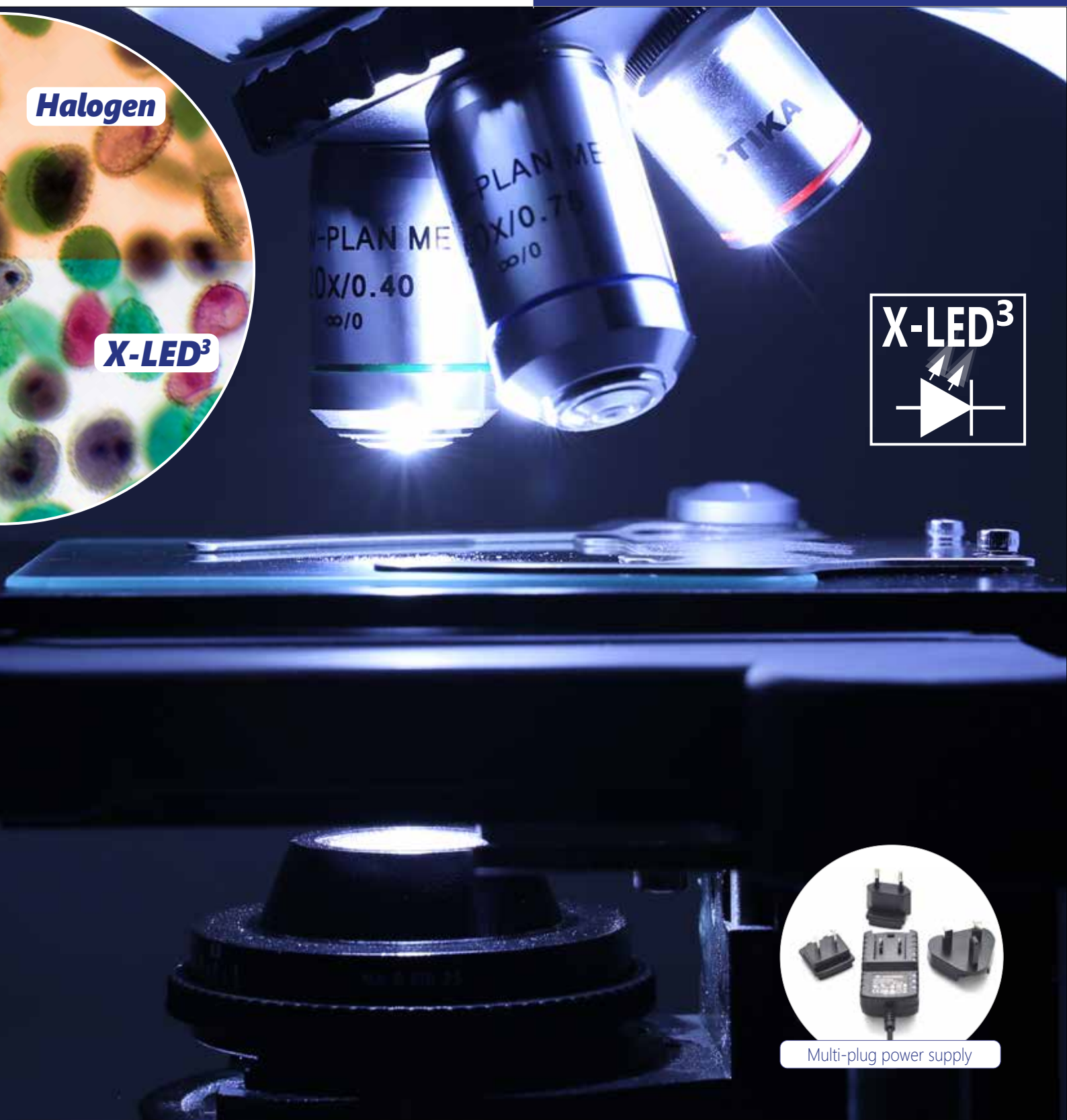
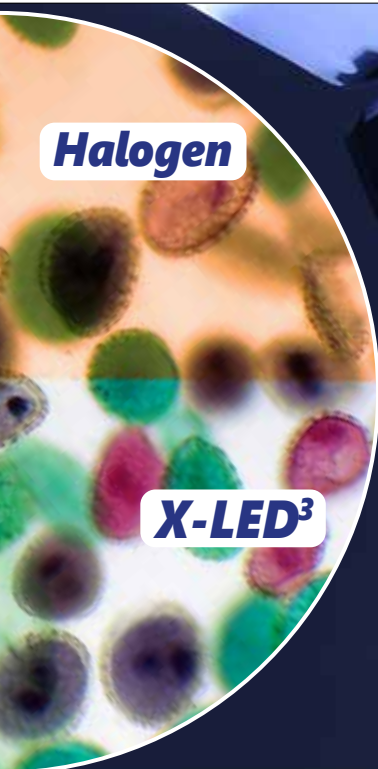

Multi-plug power supply

# Go Digital - Vivid Colors & Contrast For Stunning Images

2

## STAY CONNECTED WITH YOUR SPECIMEN, EASILY

- » Trinocular port to be always updated with the latest technology cameras, even in the future
- » Wide range of cameras matching all the needs, including the more specific ones
- » Modern C-mount focusable professional adapters for all kinds of cameras

## PROFESSIONAL IMAGE ANALYSIS

- » Multi-language software for live-view, picture and video in different file formats
- » Advanced functions for pictures processing (EDF, stitching, multi-fluorescence combine)
- » Powerful tools to perform measurements and generate custom reports

Laboratory



# B-510 Series

OPTIKA B-510 Series meets a wide variety of analysis applications, thanks to the comprehensive range of microscope models equipped with enhanced and impressive optics, a wide field of view of 22 mm, the state-of-the-art, exclusive X-LED lighting source and Koehler illuminator to produce high sample contrast and homogeneous bright light.

## A Perfect Downgrading of Top-Level Series

Many components of B-510 come from the B-810/1000 Series, the top-level in OPTIKA range, to ensure the state-of-the-art performance and at the same time an incredible level of reliability and durability. Its excellent quality/price ratio is achieved through an intelligent rationalization of production costs and choice of materials.

## X-LED<sup>3</sup> Exclusive Lighting Source

Special technology able to double the light intensity for incomparable performance, ensuring constant pure-white colour temperature (6,300K colour temperature).

Relevant money and energy saving thanks to the incredibly low energy consumptions which allows you to cut the electricity bills by 90%!

The electric consumption (3.6 W only) proves the high efficiency of this system: incredibly high light intensity combined with low consumption.

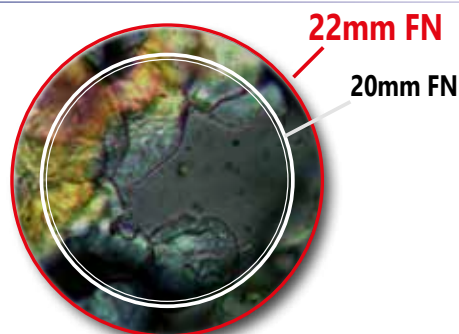

22mm FN

20mm FN

## Large Specimen View (22 mm Field Number)

The **F.O.V.** (field of view) is based on a comfortable diameter of 22 mm.

This means that an extra wide area of the sample can be inspected and allows a natural and easy view, particularly needed in a laboratory environment.

## Safe And Convenient Operations

Rounded edge rackless stage has been designed with a belt-driven mechanism that allows a smooth movement without any protruding part.

This design gives you a more compact solution and lowers any risk of injury after accidentally hitting the rack with your hands.

The electric consumption (3.6 W only) proves the high efficiency of this system: incredibly high light intensity combined with low consumption.



# Advanced Routine Lab Upright Microscopes

## Universal Condenser For Brightfield, Darkfield & Phase

OPTIKA B-510 phase contrast microscopes are equipped with a 5-position dedicated rotating condenser for brightfield (standard use), phase contrast (10x/20x, 40x and 100x phase diaphragms), and a darkfield position for dry objectives.



## Exclusive X-LED<sup>3</sup> Darkfield Condenser

The special condenser with integrated, exclusive X-LED<sup>3</sup> illuminator replaces any other external and expensive lighting source required for these applications and is ideal for great-looking, rich and high-quality specimen view.

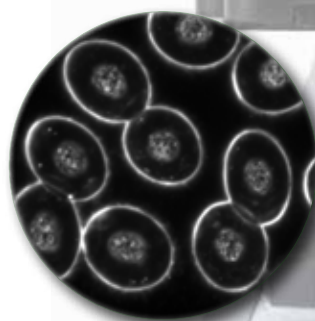

## In fluorescence we can offer several options.

According to your application and to the fluorochromes you are using, we can help you to identify the best light source.

### Traditional, HBO Fluorescence

- » The most used and diffused method, worldwide
- » Wide spectrum range for future upgrades

### Innovative, LED Fluorescence

- » Recommended for routine applications
- » Cost-effective, money saving technology
  - » Ready for immediate operation
  - » Eliminate warm-up/cool-down times
  - » Forget lamp replacement & centering



# B-510BF / B-510ERGO - Brightfield Microscope

Advanced routine laboratory microscope for brightfield observations with IOS W-PLAN objectives and rackless stage. The high-efficiency **X-LED<sup>3</sup>** makes it reliable for all transmitted light observations for great-looking, rich and high-quality view.



**B-510BF**



**B-510ERGO**

Part	Description
<b>Observation mode:</b>	Brightfield.
<b>Head:</b>	<b>B-510BF:</b> Trinocular (fixed 50/50), 30° inclined, 360° rotating. <b>B-510ERGO:</b> Binocular ergonomical head, 30°- 60° inclined, 360° rotating.
<b>Interpupillary distance:</b>	Adjustable between 50 and 75 mm.
<b>Dioptric adjustment:</b>	On the left eyepiece tube.
<b>Eyepieces:</b>	WF10x/22 mm, high eye-point and with rubber cups.
<b>Nosepiece:</b>	Quintuple revolving nosepiece, rotation on ball bearings.
<b>Objectives:</b>	IOS W-PLAN 4x/0.10 IOS W-PLAN 10x/0.25 IOS W-PLAN 40x/0.65 IOS W-PLAN 100x/1.25 (Oil) All with anti-fungus treatment.

Part	Description
<b>Specimen stage:</b>	Double layer rackless mechanical stage, 233x147 mm, 78x54 mm X-Y range.
<b>Focusing:</b>	Coaxial coarse (adjustable tension) and fine focusing mechanism with limit stop to prevent the contact between objective and specimen.
<b>Condenser:</b>	Swing-out N.A. 0.2/0.9, with iris diaphragm, focusable and centerable.
<b>Transmitted illumination (Full Koehler type):</b>	X-LED <sup>3</sup> with white 3.6 W LED (6,300K) with brightness control. Multi-plug 100-240Vac/6Vdc external power supply.



# B-510PH - Phase Contrast Microscope

Advanced routine laboratory microscope for brightfield, darkfield and phase contrast observations with IOS W-PLAN PH objectives and rackless stage. Especially dedicated to phase contrast observation, the microscope ensures a high image sharpness even with complex specimens. The high-efficiency **X-LED<sup>3</sup>** makes it reliable for all transmitted light observations.

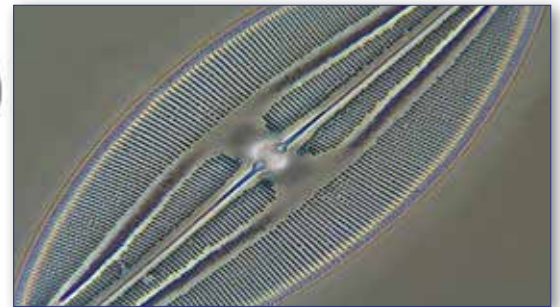

Part	Description
<b>Observation mode:</b>	Brightfield, phase contrast and darkfield (dry).
<b>Head:</b>	Trinocular (fixed 50/50), 30° inclined, 360° rotating.
<b>Interpupillary distance:</b>	Adjustable between 50 and 75 mm.
<b>Dioptric adjustment:</b>	On the left eyepiece tube.
<b>Eyepieces:</b>	WF10x/22 mm, high eye-point and with rubber cups.
<b>Nosepiece:</b>	Quintuple revolving nosepiece, rotation on ball bearings.
<b>Objectives:</b>	IOS W-PLAN PH 10x/0.25 IOS W-PLAN PH 20x/0.40 IOS W-PLAN PH 40x/0.65 IOS W-PLAN PH 100x/1.25 (Oil) All with anti-fungus treatment.

Part	Description
<b>Specimen stage:</b>	Double layer rackless mechanical stage, 233x147 mm, 78x54 mm X-Y range.
<b>Focusing:</b>	Coaxial coarse (adjustable tension) and fine focusing mechanism with limit stop to prevent the contact between objective and specimen.
<b>Condenser:</b>	Phase condenser (10x/20x, 40x, 100x) with darkfield (dry) and brightfield.
<b>Transmitted illumination (Full Koehler type):</b>	X-LED <sup>3</sup> with white 3.6 W LED (6,300K) with brightness control. Multi-plug 100-240Vac/6Vdc external power supply.

# B-510ASB - Asbestos Analysis Microscope

Advanced routine laboratory microscope for brightfield and phase contrast observations with IOS W-PLAN objectives and rackless stage. Ideal for Asbestos analysis in accordance to international rules with 12.5x eyepieces and Walton & Becket graticule to perform perfect asbestos fibers analysis at a glance. The high-efficiency **X-LED<sup>3</sup>** makes it reliable for all transmitted light observations.

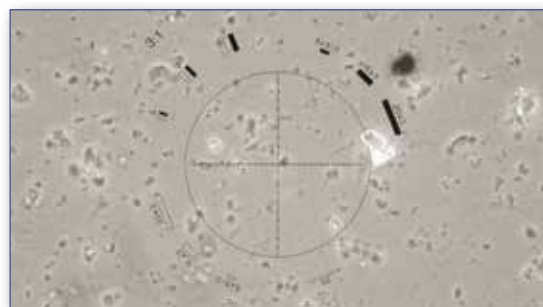

Part	Description
<b>Observation mode:</b>	Brightfield, phase contrast.
<b>Head:</b>	Trinocular (fixed 50/50), 30° inclined, 360° rotating.
<b>Interpupillary distance:</b>	Adjustable between 50 and 75 mm.
<b>Dioptric adjustment:</b>	On the left eyepiece tube.
<b>Eyepieces:</b>	WF10x/22 mm, high eye-point and WF12.5x/18 mm with dioptric adjustment, one with Walton & Beckett graticule.
<b>Nosepiece:</b>	Quintuple revolving nosepiece, rotation on ball bearings.
<b>Objectives:</b>	IOS W-PLAN 4x/0.10    IOS W-PLAN 10x/0.25 IOS W-PLAN PH 40x/0.65    IOS W-PLAN 100x/1.25 (Oil) All with anti-fungus treatment.

Part	Description
<b>Specimen stage:</b>	Double layer rackless mechanical stage, 233x147 mm, 78x54 mm X-Y range.
<b>Focusing:</b>	Coaxial coarse (adjustable tension) and fine focusing mechanism with limit stop to prevent the contact between objective and specimen.
<b>Condenser:</b>	Abbe N.A. 1.25, with objective-coded iris diaphragm, focusable and centerable. With 40x phase contrast slider.
<b>Transmitted illumination (Full Koehler type):</b>	X-LED <sup>3</sup> with white 3.6 W LED (6,300K) with brightness control. Multi-plug 100-240Vac/6Vdc external power supply.

# B-510DK - Immersion Darkfield Microscope

Advanced routine laboratory microscope for brightfield and darkfield observations with IOS W-PLAN objectives (including 100x with iris) and rackless stage for biology and especially darkfield fresh blood analysis and the exclusive **X-LED<sup>3</sup>** illumination system. The special condenser with integrated, exclusive X-LED<sup>3</sup> illuminator replaces any other external and expensive lighting source required for these applications and is ideal for great-looking, rich and high-quality specimen view. Our immersion darkfield system provides the same result achieved by 150W external illuminators in combination with traditional cardioid darkfield condenser.

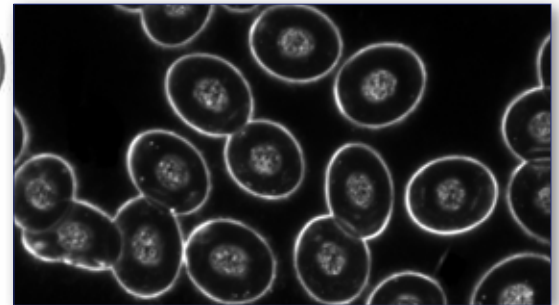

Part	Description
<b>Observation mode:</b>	Brightfield, oil immersion darkfield.
<b>Head:</b>	Trinocular (fixed 50/50), 30° inclined, 360° rotating.
<b>Interpupillary distance:</b>	Adjustable between 50 and 75 mm.
<b>Dioptric adjustment:</b>	On the left eyepiece tube.
<b>Eyepieces:</b>	WF10x/22 mm, high eye-point and with rubber cups.
<b>Nosepiece:</b>	Quintuple revolving nosepiece, rotation on ball bearings.
<b>Objectives:</b>	IOS W-PLAN 4x/0.10 IOS W-PLAN 10x/0.25 IOS W-PLAN 40x/0.65 IOS W-PLAN 100x/1.25 (oil) with iris All with anti-fungus treatment.

Part	Description
<b>Specimen stage:</b>	Double layer rackless mechanical stage, 233x147 mm, 78x54 mm X-Y range.
<b>Focusing:</b>	Coaxial coarse (adjustable tension) and fine focusing mechanism with limit stop to prevent the contact between objective and specimen.
<b>Brightfield condenser:</b>	Darkfield N.A. 1.36 (oil immersion) with built-in X-LED <sup>3</sup> .
<b>Transmitted illumination (Full Koehler type):</b>	X-LED <sup>3</sup> with white 3.6 W LED (6,300K) with brightness control. Multi-plug 100-240Vac/6Vdc external power supply.

# 2 B-510FL - HBO Fluorescence Microscope

Advanced routine laboratory microscope for brightfield and fluorescence observations with Semi-Apo IOS W-PLAN F objectives to enhance the visibility of the sample and increase the overall contrast. The **HBO fluorescence** illuminator provides an outstanding flexibility of use, standing the blue and green filter sets (supplied as standard) for Auramine, FITC, GFP and YFP (with blue filter set) plus Rhodamine, Texas Red and TRITC (with the green one), yet giving the possibility to combine any other specific filter sets for future upgrade. Transmitted light through the exclusive **X-LED<sup>3</sup>** to ensure great-looking, rich and high-quality specimen view.

-  22
- 
- 
- 
- 
- 
- 
- 

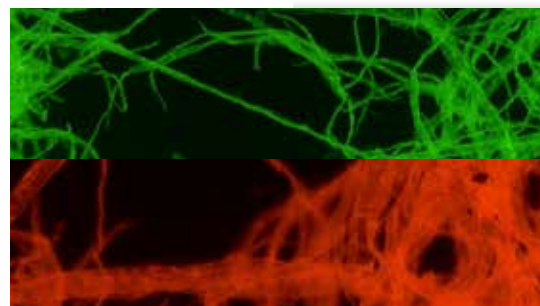

Standard filterset

Name	Excitation filter (nm)	Dichroic mirror cut-off (nm)	Emission filter (nm)
<b>B Blue</b>	460 - 490	505	515LP
<b>G Green</b>	510 - 550	570	575LP



Additional filterset (optional)

Name	Excitation filter (nm)	Dichroic mirror cut-off (nm)	Emission filter (nm)
<b>V (Violet)</b>	390 - 420	440	455LP
<b>UV</b>	325 - 375	415	435LP

Part	Description
<b>Observation mode:</b>	Brightfield, HBO fluorescence.
<b>Epi-illumination and filter:</b>	HBO 100 W high pressure mercury lamp. 4-position filter holder; blue & green included.
<b>Head:</b>	Trinocular (3-position 100/0, 50/50, 0/100), 30° inclined, 360° rotating.
<b>Interpupillary distance:</b>	Adjustable between 50 and 75 mm.
<b>Dioptric adjustment:</b>	On the left eyepiece tube.
<b>Eyepieces:</b>	WF10x/22 mm, high eye-point and with rubber cups.
<b>Nosepiece:</b>	Quintuple revolving nosepiece, rotation on ball bearings.
<b>Objectives:</b>	IOS W-PLAN F 4x/0.13      IOS W-PLAN F 10x/0.30 IOS W-PLAN F 20x/0.50    IOS W-PLAN F 40x/0.75 All with anti-fungus treatment.

Part	Description
<b>Specimen stage:</b>	Double layer rackless mechanical stage, 233x147 mm, 78x54 mm X-Y range.
<b>Focusing:</b>	Coaxial coarse (adjustable tension) and fine focusing mechanism with limit stop to prevent the contact between objective and specimen.
<b>Condenser:</b>	Swing-out N.A. 0.2/0.9, with iris diaphragm, focusable and centerable.
<b>Transmitted illumination (Full Koehler type):</b>	X-LED <sup>3</sup> with white 3.6 W LED (6,300K) with brightness control. Multi-plug 100-240Vac/6Vdc external power supply.

# B-510LD1 - LED Fluorescence Microscope

Advanced routine fluorescence microscope for transmitted brightfield and fluorescence observations with IOS W-PLAN objectives. The extremely powerful LED fluorescence illuminator is combined with blue excitation filter set for the visualization of the following fluorochromes: Acridine Yellow, Acridine Orange, Auramine, DiO, DTAF, FITC, GFP, YFP, etc. LED fluorescence ensures unparalleled convenience eliminating warm-up/cool-down times and all the inconveniences related lamp replacement and adjustment. Transmitted light through the exclusive **X-LED<sup>3</sup>** to ensure great-looking, rich and high-quality specimen view.

-  22
- 
- 
- 
- 
- 
- 
- 

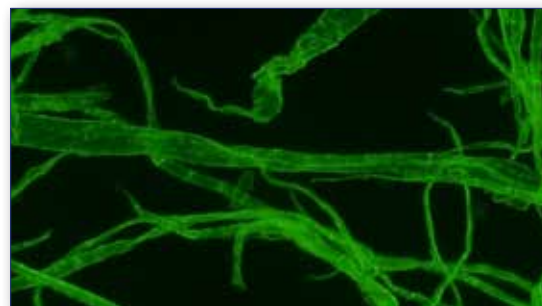

Standard filterset

Name	Excitation filter (nm)	Dichroic mirror cut-off (nm)	Emission filter (nm)
B Blue	460 – 490	505	515LP

Part	Description
<b>Observation mode:</b>	Brightfield, LED fluorescence.
<b>Epi-illumination and filter:</b>	High-power blue LED with brightness control. 3-position filter holder; blue included.
<b>Head:</b>	Trinocular (3-position 100/0, 50/50, 0/100), 30° inclined, 360° rotating.
<b>Interpupillary distance:</b>	Adjustable between 50 and 75 mm.
<b>Dioptric adjustment:</b>	On the left eyepiece tube.
<b>Eyepieces:</b>	WF10x/22 mm, high eye-point and with rubber cups.
<b>Nosepiece:</b>	Quintuple revolving nosepiece, rotation on ball bearings.
<b>Objectives:</b>	IOS W-PLAN 4x/0.10      IOS W-PLAN 10x/0.25 IOS W-PLAN 40x/0.65    IOS W-PLAN 100x/1.25 (Oil) All with anti-fungus treatment.

Part	Description
<b>Specimen stage:</b>	Double layer rackless mechanical stage, 233x147 mm, 78x54 mm X-Y range.
<b>Focusing:</b>	Coaxial coarse (adjustable tension) and fine focusing mechanism with limit stop to prevent the contact between objective and specimen.
<b>Condenser:</b>	Swing-out N.A. 0.2/0.9, with iris diaphragm, focusable and centerable.
<b>Transmitted illumination (Full Koehler type):</b>	X-LED <sup>3</sup> with white 3.6 W LED (6,300K) with brightness control. Multi-plug 100-240Vac/6Vdc external power supply.

# B-510LD2 - LED Fluorescence Microscope

Advanced routine fluorescence microscope for transmitted brightfield and fluorescence observations with IOS W-PLAN objectives. The extremely powerful LED fluorescence illuminator is combined with blue and green excitation filter set for the visualization of the following fluorochromes: Acridine Yellow, Acridine Orange, Auramine, DiO, DTAF, FITC, GFP, YFP, etc. (blue) plus Rhodamine, Texas Red and TRITC (green). LED fluorescence ensures unparalleled convenience eliminating warm-up/cool-down times and all the inconveniences related lamp replacement and adjustment. Transmitted light through the exclusive **X-LED<sup>3</sup>** to ensure great-looking, rich and high-quality specimen view.

-  22
- 
- 
- 
- 
- 
- 
- 

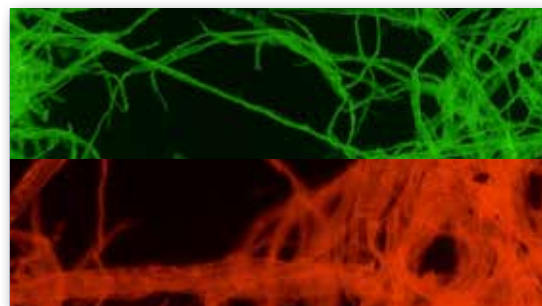

### Standard filterset

Name	Excitation filter (nm)	Dichroic mirror cut-off (nm)	Emission filter (nm)
<b>B Blue</b>	460 - 490	505	515LP
<b>G Green</b>	510 - 550	570	575LP

Part	Description
<b>Observation mode:</b>	Brightfield, LED fluorescence.
<b>Epi-illumination and filters:</b>	High-power wide spectrum LED with brightness control. 3-position filter holder; blue and green included.
<b>Head:</b>	Trinocular (3-position 100/0, 50/50, 0/100), 30° inclined, 360° rotating.
<b>Interpupillary distance:</b>	Adjustable between 50 and 75 mm.
<b>Dioptric adjustment:</b>	On the left eyepiece tube.
<b>Eyepieces:</b>	WF10x/22 mm, high eye-point and with rubber cups.
<b>Nosepiece:</b>	Quintuple revolving nosepiece, rotation on ball bearings.
<b>Objectives:</b>	IOS W-PLAN 4x/0.10      IOS W-PLAN 10x/0.25 IOS W-PLAN 40x/0.65    IOS W-PLAN 100x/1.25 (Oil) All with anti-fungus treatment.

Part	Description
<b>Specimen stage:</b>	Double layer rackless mechanical stage, 233x147 mm, 78x54 mm X-Y range.
<b>Focusing:</b>	Coaxial coarse (adjustable tension) and fine focusing mechanism with limit stop to prevent the contact between objective and specimen.
<b>Condenser:</b>	Swing-out N.A. 0.2/0.9, with iris diaphragm, focusable and centerable.
<b>Transmitted illumination (Full Koehler type):</b>	X-LED <sup>3</sup> with white 3.6 W LED (6,300K) with brightness control. Multi-plug 100-240Vac/6Vdc external power supply.

# B-510POL - Polarizing Microscope

2

Advanced routine laboratory microscope for transmitted light in brightfield and polarized light observations with strain-free IOS W-PLAN POL objectives. Complete of polarizer and analyzer filters, Bertrand lens for conoscopic observation, compensator plates and high-precision rotatable stages. It comes with the exclusive **X-LED<sup>3</sup>** illumination system to deliver bright and clear images, along with all the accessories to perform accurate polarization analysis in biology and materials science.

Laboratory

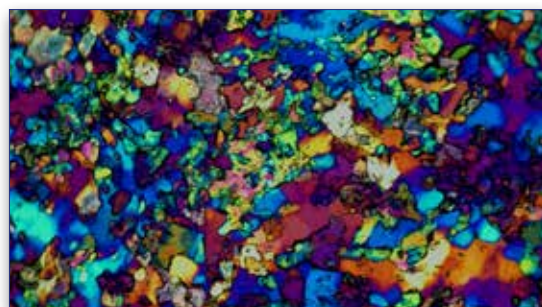

Part	Description
<b>Observation mode:</b>	Brightfield, transmitted polarized light and conoscopy.
<b>Bertrand lens and polarizing attachment:</b>	Swing-out type with centering mechanism for observation in conoscopy/orthoscopy. Rotatable analyzer from 0° to 90° with graduated scale. Tint plates: 1° order red ( $\lambda$ ); $\lambda/4$ ; Quartz wedge.
<b>Head:</b>	Trinocular (fixed 50/50), 30° inclined, 360° rotating.
<b>Interpupillary distance:</b>	Adjustable between 50 and 75 mm.
<b>Dioptric adjustment:</b>	On the left eyepiece tube.
<b>Eyepieces:</b>	WF10x/22 mm, high eye-point and with rubber cups. One with crosshair.
<b>Nosepiece:</b>	Quadruple revolving nosepiece, rotation on ball bearings. Centering system for each objective.

Part	Description
<b>Objectives (strain-free):</b>	IOS W-PLAN POL 4x/0.10    IOS W-PLAN POL 10x/0.25 IOS W-PLAN POL 20x/0.45    IOS W-PLAN POL 40x/0.65 All with anti-fungus treatment.
<b>Specimen stage:</b>	Rotatable stage with locking mechanism and centering knobs. Vernier scale with accuracy 0.1 mm. Diameter 145 mm. Specimen slide clamps.
<b>Focusing:</b>	Coaxial coarse (adjustable tension) and fine focusing mechanism with limit stop to prevent the contact between objective and specimen.
<b>Condenser:</b>	Swing-out N.A. 0.2/0.9, with iris diaphragm, focusable and centerable. With rotating polarizing filter.
<b>Transmitted illumination (Full Koehler type):</b>	X-LED <sup>3</sup> with white 3.6 W LED (6.300 K) with brightness control. Multi-plug 100-240Vac/6Vdc external power supply.

# B-510POL-I - Polarizing Microscope

Advanced routine laboratory microscope for brightfield and polarized light observations in transmitted and incident light with strain-free IOS LWD W-PLAN POL objectives. Complete of polarizer and analyzer filters, Bertrand lens for conoscopic observation, compensator plates and high-precision rotatable stages. It comes with the exclusive **X-LED<sup>3</sup>** illumination system to deliver bright and clear images, along with all the accessories to perform accurate polarization analysis in biology and materials science.

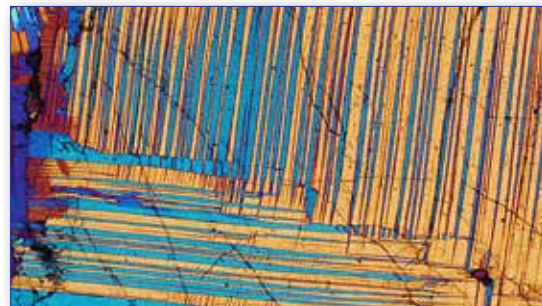

## Incident/transmitted light Objectives included

### Description

IOS LWD W-PLAN POL 5x/0.12, W.D. 15.5 mm

IOS LWD W-PLAN POL 10x/0.25, W.D. 10.0 mm

IOS LWD W-PLAN POL 20x/0.40, W.D. 5.8 mm

IOS LWD W-PLAN POL 50x/0.75, W.D. 0.32 mm









Part	Description
<b>Observation mode:</b>	Brightfield, transmitted/incident polarized light and conoscopy.
<b>Epi-illumination and filters:</b>	X-LED <sup>3</sup> with white 8 W LED (6.300 K) with brightness control. With polarizer and rotating analyzer for incident illumination, aperture and field diaphragm. With additional filter holder.
<b>Bertrand lens and polarizing attachment:</b>	Swing-out type with centering mechanism for observation in conoscopy/orthoscopy. Rotatable analyzer from 0° to 90° with graduated scale. Tint plates: 1° order red ( $\lambda$ ); $\lambda/4$ ; Quartz wedge.
<b>Head:</b>	Trinocular (fixed 50/50), 30° inclined, 360° rotating.
<b>Interpupillary distance:</b>	Adjustable between 50 and 75 mm.
<b>Dioptric adjustment:</b>	On the left eyepiece tube.
<b>Eyepieces:</b>	WF10x/22 mm, high eye-point and with rubber cups. One with crosshair.
<b>Nosepiece:</b>	Quadruple revolving nosepiece, rotation on ball bearings. Centering system for each objective.

Part	Description
<b>Objectives (strain-free):</b>	IOS LWD W-PLAN POL 5x/0.12 IOS LWD W-PLAN POL 10x/0.25 IOS LWD W-PLAN POL 20x/0.40 IOS LWD W-PLAN POL 50x/0.75 All with anti-fungus treatment.
<b>Specimen stage:</b>	Rotatable stage with locking mechanism and centering knobs. Vernier scale with accuracy 0.1 mm. Diameter 145 mm. Specimen slide clamps.
<b>Focusing:</b>	Coaxial coarse (adjustable tension) and fine focusing mechanism with limit stop to prevent the contact between objective and specimen.
<b>Condenser:</b>	Swing-out N.A. 0.2/0.9, with iris diaphragm, focusable and centerable. With rotating polarizing filter.
<b>Transmitted illumination (Full Koehler type):</b>	X-LED <sup>3</sup> with white 3.6 W LED (6.300 K) with brightness control. Multi-plug 100-240Vac/6Vdc external power supply.



# B-510MET - Metallurgical Microscope

Advanced routine laboratory microscope with IOS W-PLAN MET objectives and metallurgical attachment with the exclusive **X-LED<sup>3</sup>** lighting source for incident illumination only. The NCG (no cover glass) objectives are especially designed for microscopy use without a cover slip ideal for metallographic samples and other opaque specimens.

-  22
- 
- 
- 
- 
- 
- 
- 

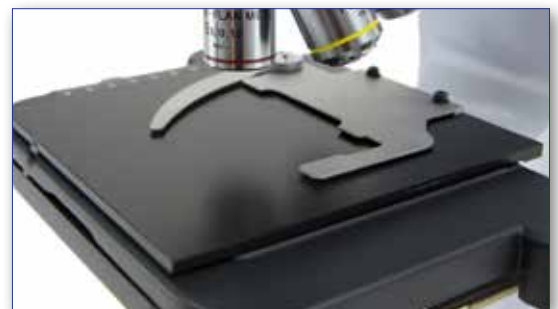
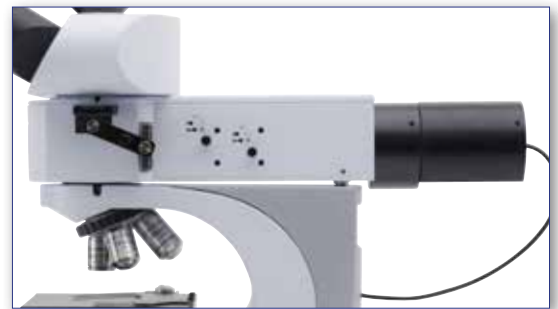
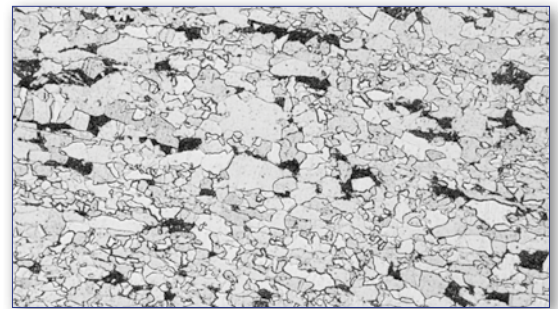

Part	Description
<b>Observation mode:</b>	Brightfield, simple polarized light, oblique illumination on incident light.
<b>Epi-illumination and polarizing filters:</b>	X-LED <sup>3</sup> with white 8 W LED (6.300 K) with brightness control. With aperture and field diaphragms, and oblique illumination system. With polarizer and analyzer. Multi-plug 100-240Vac/6Vdc external power supply.
<b>Head:</b>	Trinocular (fixed 50/50), 30° inclined, 360° rotating.
<b>Interpupillary distance:</b>	Adjustable between 50 and 75 mm.
<b>Dioptric adjustment:</b>	On the left eyepiece tube.
<b>Eyepieces:</b>	WF10x/22 mm, high eye-point and with rubber cups.
<b>Nosepiece:</b>	Quintuple revolving nosepiece, rotation on ball bearings.

Part	Description
<b>Objectives (strain-free):</b>	IOS W-PLAN MET 5x/0.12 IOS W-PLAN MET 10x/0.25 IOS W-PLAN MET 20x/0.40 IOS W-PLAN MET 50x/0.75 All with anti-fungus treatment.
<b>Specimen stage:</b>	Double layer rackless mechanical stage, 233x147 mm, 78x54 mm X-Y range.
<b>Focusing:</b>	Coaxial coarse (adjustable tension) and fine focusing mechanism with limit stop to prevent the contact between objective and specimen.

# 2 B-510METR - Metallurgical Microscope

Advanced routine laboratory microscope with IOS W-PLAN MET objectives and metallurgical attachment with the exclusive **X-LED<sup>3</sup>** lighting source for both transmitted and incident illumination. The NCG (no cover glass) objectives are especially designed for microscopy use without a cover slip ideal for metallographic samples and other opaque specimens.

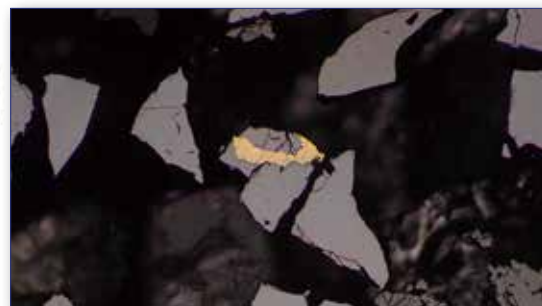

Part	Description
<b>Observation mode:</b>	Brightfield on transmitted light. Brightfield, simple polarized light, oblique illumination on incident light.
<b>Epi-illumination and polarizing filters:</b>	X-LED <sup>8</sup> with white 8 W LED (6.300 K) with brightness control. With aperture and field diaphragms, and oblique illumination system. With polarizer and analyzer.
<b>Head:</b>	Trinocular (fixed 50/50), 30° inclined, 360° rotating.
<b>Interpupillary distance:</b>	Adjustable between 50 and 75 mm.
<b>Dioptric adjustment:</b>	On the left eyepiece tube.
<b>Eyepieces:</b>	WF10x/22 mm, high eye-point and with rubber cups.
<b>Nosepiece:</b>	Quintuple revolving nosepiece, rotation on ball bearings.

Part	Description
<b>Objectives (strain-free):</b>	IOS W-PLAN MET 5x/0.12 IOS W-PLAN MET 10x/0.25 IOS W-PLAN MET 20x/0.40 IOS W-PLAN MET 50x/0.75 All with anti-fungus treatment.
<b>Specimen stage:</b>	Double layer rackless mechanical stage, 233x147 mm, 78x54 mm X-Y range. With tempered glass plate.
<b>Focusing:</b>	Coaxial coarse (adjustable tension) and fine focusing mechanism with limit stop to prevent the contact between objective and specimen.
<b>Condenser:</b>	Swing-out N.A. 0.2/0.9, with iris diaphragm, focusable and centerable.
<b>Transmitted illumination (Full Koehler type):</b>	X-LED <sup>3</sup> with white 3.6 W LED (6.300 K) with brightness control. Multi-plug 100-240Vac/6Vdc external power supply.

# B-510 - Discussion Microscopes

Advanced routine laboratory microscope for brightfield observations with IOS W-PLAN objectives and rackless stage. Ideal for discussion groups and teaching purpose for multiple observers, up to five users simultaneously. A three-color LED pointer facilitates the indication and identification of the object observed. The high-efficiency **X-LED<sup>3</sup>** makes it reliable for all transmitted light observations for great-looking, rich and high-quality view.



**B-510-2F**



**B-510-2**



**B-510-3**



**B-510-5**

Part	Description
<b>Observation mode:</b>	Brightfield
<b>Head:</b>	Trinocular (fixed photo port 50/50), 30° inclined, 360° rotating.
<b>Interpupillary distance:</b>	Adjustable between 50 and 75 mm.
<b>Dioptric adjustment:</b>	On the left eyepiece tube.
<b>Eyepieces:</b>	Main head: WF10x/22 mm, high eye-point and with rubber cups. Additional head(s): WF10x/20 mm, high eye-point.
<b>Nosepiece:</b>	Quintuple revolving nosepiece, rotation on ball bearings.
<b>Objectives:</b>	IOS W-PLAN 4x/0.10      IOS W-PLAN 10x/0.25 IOS W-PLAN 40x/0.65    IOS W-PLAN 100x/1.25 (Oil) All with anti-fungus treatment.

Part	Description
<b>Specimen stage:</b>	Double layer rackless mechanical stage, 233x147 mm, 78x54 mm X-Y range.
<b>Focusing:</b>	Coaxial coarse (adjustable tension) and fine focusing mechanism with limit stop to prevent the contact between objective and specimen.
<b>Condenser:</b>	Swing-out N.A. 0.2/0.9, with iris diaphragm, focusable and centerable.
<b>Transmitted illumination (Full Koehler type):</b>	X-LED <sup>3</sup> with white 3.6 W LED (6,300K) with brightness control. Multi-plug 100-240Vac/6Vdc external power supply.

# B-510 Series - Comparison chart

Model	Head	Eyepieces	Nosepiece	Attachment	Objectives
<b>B-510BF</b>	Trinocular (50/50), 30° inclined, 360° rotating	WF10x/22mm, high eye-point	Quintuple, reversed	-	IOS W-PLAN 4x, 10x, 40x, 100x (oil)
<b>B-510ERGO</b>	Binocular ergonomical, 30°- 60° inclined 360° rotating	WF10x/22mm, high eye-point	Quintuple, reversed	-	IOS W-PLAN 4x, 10x, 40x, 100x (oil)
<b>B-510PH</b>	Trinocular (50/50), 30° inclined, 360° rotating	WF10x/22mm, high eye-point	Quintuple, reversed	-	IOS W-PLAN PH 10x, 20x, 40x, 100x (oil)
<b>B-510ASB</b>	Trinocular (50/50), 30° inclined, 360° rotating	WF10x/22mm, high eye-point WF12.5x/18mm w/W&B reticle	Quintuple, reversed	-	IOS W-PLAN 4x, 10x, 40xPH, 100x (oil)
<b>B-510DK</b>	Trinocular (50/50), 30° inclined, 360° rotating	WF10x/22mm, high eye-point	Quintuple, reversed	-	IOS W-PLAN 4x, 10x, 40x, 100x with iris diaphragm (oil)
<b>B-510FL</b>	Trinocular (100/0, 50/50, 0/100), 30° inclined, 360° rotating	WF10x/22mm, high eye-point	Quintuple, reversed	Epi-Florescence attachment, with 4-position filterset slider. Equipped with Blue (FITC) and Green (TRITC) filtersets	IOS W-PLAN F 4x, 10x, 20x, 40x (oil)
<b>B-510LD1</b>	Trinocular (3-position 100/0, 50/50, 0/100), 30° inclined, 360° rotating.	WF10x/22mm, high eye-point	Quintuple, reversed	Epi-Florescence attachment, with 3-position filterset slider. Equipped with Blue filterset (FITC)	IOS W-PLAN 4x, 10x, 40x, 100x (oil)
<b>B-510LD2</b>	Trinocular (3-position 100/0, 50/50, 0/100), 30° inclined, 360° rotating.	WF10x/22mm, high eye-point	Quintuple, reversed	Epi-Florescence attachment, with 3-position filterset slider. Equipped with Blue (FITC) and Green (TRITC) filtersets	IOS W-PLAN 4x, 10x, 40x, 100x (oil)
<b>B-510POL</b>	Trinocular (50/50), 30° inclined, 360° rotating	WF10x/22mm, high eye-point	Quadruple, reversed. Objective positions centrabale.	Swing-out Bertrand lens with centering mechanism for observation in conoscopy/orthoscopy. Rotatable analyzer from 0° to 90° with graduated scale. Tint plates: 1° order red ( $\lambda$ ); $\lambda/4$ ; Quartz wedge	IOS W-PLAN POL 4x, 10x, 20x, 40x
<b>B-510POL-I</b>	Trinocular (50/50), 30° inclined, 360° rotating	WF10x/22mm, high eye-point	Quadruple, reversed. Objective positions centrabale.	Incident light attachment with Polarizer for incident illumination, with Aperture & Field diaphragms and additional filter holder. Swing-out Bertrand lens with centering mechanism for observation in conoscopy/orthoscopy. Rotatable analyzer from 0° to 90° with graduated scale. Tint plates: 1° order red ( $\lambda$ ); $\lambda/4$ ; Quartz wedge	IOS LWD W-PLAN POL 5x, 10x, 20x, 50x
<b>B-510MET</b>	Trinocular (50/50), 30° inclined, 360° rotating	WF10x/22mm, high eye-point	Quintuple, reversed	Incident light attachment with Polarizer and rotating Analyzer for incident illumination, with Aperture & Field diaphragms and 2 additional filter holders. Oblique illumination	IOS W-PLAN MET 5x, 10x, 20x, 50x
<b>B-510METR</b>	Trinocular (50/50), 30° inclined, 360° rotating	WF10x/22mm, high eye-point	Quintuple, reversed	Incident light attachment with Polarizer and rotating Analyzer for incident illumination, with Aperture & Field diaphragms and 2 additional filter holders; Epi/Transmitted light selector. Oblique illumination	IOS W-PLAN MET 5x, 10x, 20x, 50x
<b>B-510-2F</b>	Trinocular (50/50), 30° inclined, 360° rotating	WF10x/22mm, high eye-point	Quintuple, reversed	Discussion bridge for 2 observers , Face-to-Face type. 2nd binocular head with WF10x/20mm eyepieces. Equipped with RGB discussion pointer	IOS W-PLAN 4x, 10x, 40x, 100x (oil)
<b>B-510-2</b>	Trinocular (50/50), 30° inclined, 360° rotating	WF10x/22mm, high eye-point	Quintuple, reversed	Discussion bridge for 2 observers , Side-by-Side type. 2nd binocular head with WF10x/20mm eyepieces. Equipped with RGB discussion pointer	IOS W-PLAN 4x, 10x, 40x, 100x (oil)
<b>B-510-3</b>	Trinocular (50/50), 30° inclined, 360° rotating	WF10x/22mm, high eye-point	Quintuple, reversed	Discussion bridge for 3 observers. Additional binocular heads with WF10x/20mm eyepieces. Equipped with RGB discussion pointer	IOS W-PLAN 4x, 10x, 40x, 100x (oil)
<b>B-510-5</b>	Trinocular (50/50), 30° inclined, 360° rotating	WF10x/22mm, high eye-point	Quintuple, reversed	Discussion bridge for 5 observers. Additional binocular heads with WF10x/20mm eyepieces. Equipped with RGB discussion pointer	IOS W-PLAN 4x, 10x, 40x, 100x (oil)

# B-510 Series - Comparison chart

Stage	Focusing	Condenser	Incident Illumination	Transmitted Illumination
Double layer, 233x147 mm, moving range 78x54 mm, X-axis rackless	Coaxial coarse and fine, limit stop, adjustable tension	Swing-out type, sliding-in, N.A. 0.2/0.9, with centering system	-	X-LED <sup>3</sup> with white 3.6 W LED (6,300K), brightness control. Full Koehler type.
Double layer, 233x147 mm, moving range 78x54 mm, X-axis rackless	Coaxial coarse and fine, limit stop, adjustable tension	Swing-out type, sliding-in, N.A. 0.2/0.9, with centering system	-	X-LED <sup>3</sup> with white 3.6 W LED (6,300K), brightness control. Full Koehler type.
Double layer, 233x147 mm, moving range 78x54 mm, X-axis rackless	Coaxial coarse and fine, limit stop, adjustable tension	Phase condenser (10x/20x, 40x, 100x) with darkfield (dry) and brightfield	-	X-LED <sup>3</sup> with white 3.6 W LED (6,300K), brightness control. Full Koehler type.
Double layer, 233x147 mm, moving range 78x54 mm, X-axis rackless	Coaxial coarse and fine, limit stop, adjustable tension	Abbe N.A. 1.25, with objective-coded iris diaphragm, focusable and centerable. With 40x phase contrast slider.	-	X-LED <sup>3</sup> with white 3.6 W LED (6,300K), brightness control. Full Koehler type.
Double layer, 233x147 mm, moving range 78x54 mm, X-axis rackless	Coaxial coarse and fine, limit stop, adjustable tension	Swing-out type, sliding-in, N.A. 0.2/0.9, with centering system. Additional darkfield condenser, N.A. 1.36, built-in X-LED <sup>3</sup>	-	X-LED <sup>3</sup> with white 3.6 W LED (6,300K), brightness control. Full Koehler type.
Double layer, 233x147 mm, moving range 78x54 mm, X-axis rackless	Coaxial coarse and fine, limit stop, adjustable tension	Swing-out type, sliding-in, N.A. 0.2/0.9, with centering system	High Pressure HBO 100 W mercury bulb	X-LED <sup>3</sup> with white 3.6 W LED (6,300K), brightness control. Full Koehler type.
Double layer, 233x147 mm, moving range 78x54 mm, X-axis rackless	Coaxial coarse and fine, limit stop, adjustable tension	Swing-out type, sliding-in, N.A. 0.2/0.9, with centering system	High-power blue LED with brightness control	X-LED <sup>3</sup> with white 3.6 W LED (6,300K), brightness control. Full Koehler type.
Double layer, 233x147 mm, moving range 78x54 mm, X-axis rackless	Coaxial coarse and fine, limit stop, adjustable tension	Swing-out type, sliding-in, N.A. 0.2/0.9, with centering system	High-power wide spectrum LED with brightness control	X-LED <sup>3</sup> with white 3.6 W LED (6,300K), brightness control. Full Koehler type.
Rotating stage with locking mechanism and centering knobs. Vernier scale with accuracy 0.1 mm. Diameter 145 mm; Specimen slide clamps	Coaxial coarse and fine, limit stop, adjustable tension	Swing-out type, sliding-in, N.A. 0.2/0.9, with centering system. With rotating polarizing filter	-	X-LED <sup>3</sup> with white 3.6 W LED (6,300K), brightness control. Full Koehler type.
Rotating stage with locking mechanism and centering knobs. Vernier scale with accuracy 0.1 mm. Diameter 145 mm; Specimen slide clamps	Coaxial coarse and fine, limit stop, adjustable tension	Swing-out type, sliding-in, N.A. 0.2/0.9, with centering system. With rotating polarizing filter	X-LED <sup>3</sup> with white 8 W LED (6,300K), brightness control	X-LED <sup>3</sup> with white 3.6 W LED (6,300K), brightness control. Full Koehler type.
Double layer, 233x147 mm, moving range 78x54 mm, X-axis rackless; with metal plate for metallurgical samples	Coaxial coarse and fine, limit stop, adjustable tension	-	X-LED <sup>3</sup> with white 8 W LED (6,300K), brightness control	-
Double layer, 233x147 mm, moving range 78x54 mm, X-axis rackless; with glass plate for metallurgical samples	Coaxial coarse and fine, limit stop, adjustable tension	Swing-out type, sliding-in, N.A. 0.2/0.9, with centering system	X-LED <sup>3</sup> with white 8 W LED (6,300K), brightness control	X-LED <sup>3</sup> with white 3.6 W LED (6,300K), brightness control. Full Koehler type.
Double layer, 233x147 mm, moving range 78x54 mm, X-axis rackless	Coaxial coarse and fine, limit stop, adjustable tension	Swing-out type, sliding-in, N.A. 0.2/0.9, with centering system	-	X-LED <sup>3</sup> with white 3.6 W LED (6,300K), brightness control. Full Koehler type.
Double layer, 233x147 mm, moving range 78x54 mm, X-axis rackless	Coaxial coarse and fine, limit stop, adjustable tension	Swing-out type, sliding-in, N.A. 0.2/0.9, with centering system	-	X-LED <sup>3</sup> with white 3.6 W LED (6,300K), brightness control. Full Koehler type.
Double layer, 233x147 mm, moving range 78x54 mm, X-axis rackless	Coaxial coarse and fine, limit stop, adjustable tension	Swing-out type, sliding-in, N.A. 0.2/0.9, with centering system	-	X-LED <sup>3</sup> with white 3.6 W LED (6,300K), brightness control. Full Koehler type.
Double layer, 233x147 mm, moving range 78x54 mm, X-axis rackless	Coaxial coarse and fine, limit stop, adjustable tension	Swing-out type, sliding-in, N.A. 0.2/0.9, with centering system	-	X-LED <sup>3</sup> with white 3.6 W LED (6,300K), brightness control. Full Koehler type.

## ② B-510 Series - Accessories

### Eyecups & Eyepieces

- M-601 WF15x/16 eyepiece, high eyepoint
- M-690 Eyecups (pair)
- M-780 PL10x/22 eyepiece, high eyepoint, with rubber cup
- M-781 PL10x/22 micrometric eyepiece, high eyepoint, with rubber cup

### Objectives & Additional Lenses

#### IOS W-PLAN

- M-1049 IOS W-PLAN objective 2x/0.08
- M-1125 IOS W-PLAN objective 4x/0.10
- M-1126 IOS W-PLAN objective 10x/0.25
- M-1127 IOS W-PLAN objective 20x/0.40
- M-1128 IOS W-PLAN objective 40x/0.65
- M-634.1 IOS W-PLAN objective 50x/0.95 (oil)
- M-1129 IOS W-PLAN objective 60x/0.80
- M-1130 IOS W-PLAN objective 100x/1.25 (oil)
- M-1130.1 IOS W-PLAN objective 100x/1.25OI - (oil) with iris for DF

#### IOS W-PLAN F

- M-1060 IOS W-PLAN F objective 4x/0.13
- M-1061 IOS W-PLAN F objective 10x/0.30
- M-1062 IOS W-PLAN F objective 20x/0.50
- M-1063 IOS W-PLAN F objective 40x/0.75
- M-1064 IOS W-PLAN F objective 100x/1.30 (oil)

#### IOS W-PLAN MET

- M-336 IOS W-PLAN MET objective 5x/0.12
- M-338 IOS W-PLAN MET objective 10x/0.25
- M-339 IOS W-PLAN MET objective 20x/0.40
- M-335 IOS W-PLAN MET objective 50x/0.75
- M-698.2 IOS W-PLAN MET objective 100x/0.80 (dry)

#### IOS W-PLAN PH

- M-1120.N IOS W-PLAN PH objective 10x/0.25
- M-1121.N IOS W-PLAN PH objective 20x/0.40
- M-1122.N IOS W-PLAN PH objective 40x/0.65
- M-1123.N IOS W-PLAN PH objective 100x/1.25 (oil)

#### IOS W-PLAN POL

- M-1131 IOS W-PLAN POL objective 4x/0.10
- M-1132 IOS W-PLAN POL objective 10x/0.25
- M-1133 IOS W-PLAN POL objective 20x/0.45
- M-1134 IOS W-PLAN POL objective 40x/0.65
- M-1135 IOS W-PLAN POL objective 60x/0.80
- M-1136 IOS LWD W-PLAN POL objective 5x/0.12
- M-1137 IOS LWD W-PLAN POL objective 10x/0.25
- M-1138 IOS LWD W-PLAN POL objective 20x/0.40
- M-1139 IOS LWD W-PLAN POL objective 50x/0.75

- M-181 PH set - 10x, 20x, 40x, 100x IOS W-PLAN PH obj. & BF/DF/PH condenser



# B-510 Series - Accessories

## Stages

- M-175.1 Rotating stage for polarising set (for 233x147mm rackless stage)
- M-635-EU Heating stage (on newly purchased microscopes, for 233x147mm), EU
- M-635-UK Heating stage (on newly purchased microscopes, for 233x147mm), UK
- M-635-US Heating stage (on newly purchased microscopes, for 233x147mm), US
- M-635-SW Heating stage (on newly purchased microscopes, for 233x147mm), CH

## Condensers & Filters

- M-185 Darkfield condenser for dry objectives (except for B-510DK, B-510MET and B-510METR)
- M-636 Polarising set (filters only) (except for B-510POL & B-510POL-I)
- M-637 Fluorescence filter set V (filterblock not needed) (only for B-510FL)
- M-638 Fluorescence filter set UV-DAPI (filterblock not needed) (only for B-510FL)
- M-975 Blue filter, 45mm diameter
- M-977 Green filter, 45mm diameter
- M-979 Yellow filter, 45mm diameter
- M-989 Frosted glass filter, 45mm diameter

## Camera Adapters

- M-113.1 Ring adapter, 30mm (for monocular and binocular microscopes)
- M-115 0.35x C-Mount projection lens
- M-114 0.5x C-Mount projection lens
- M-118 0.75x C-Mount projection lens
- M-173 C-Mount projection lens for APS-C/full frame reflex cameras (trino)
- M-620 0.35x focusable C-Mount adapter (biological microscopes)
- M-620.1 0.5x focusable C-Mount adapter (biological microscopes)
- M-620.2 0.65x focusable C-Mount adapter (biological microscopes)
- M-620.3 1x focusable C-Mount adapter (biological & stereomicroscopes)
- M-699 Universal adapter for C-Mount projection lens (trino)

## Miscellaneous

- 15008 Immersion oil, 10ml
- 15009 Immersion oil, 100ml
- 15104 Cleaning kit
- AA-02 HSE-NPL Mark II phase contrast test slide, with certification (only for B-510ASB)
- DC-003 TNT dust cover, medium, 600(l)x550(h) mm
- M-005 Micrometric slide, 26x76mm, with 2 scales (1mm/100 & 10mm/100)
- M-069 Solar charger (except for B-510MET, B-510METR and B-510POL-I)
- M-151 HBO 100W high-pressure mercury bulb for fluorescence (only for B-510FL)
- M-151.1 HBO 100W high-pressure mercury bulb for fluorescence (OSRAM) (only for B-510FL)
- M-1004.N Centering telescope, 30mm diameter (except for B-510MET, B-510METR, B-510POL and B-510POL-I)
- M-1037 Gout analysis kit (only for B-510BF, B-510ERGO and B-510PH)
- VP-510 IQ/OQ/PQ manual for B-510 series



### How to connect the cameras to our microscopes.

Please refer to the Adapter reference list on Digital section.

### 15104 - Cleaning kit

It cleans glass quickly and effectively, without leaving residue or odor. Ideal for precision lens or prism cleaning.



### M-069 - Solar charger

Included battery: rechargeable – Lithium-Poly. Capacity: 2600 mAh. Output voltage: 5.5Vdc. - Dimensions: 120x73x10 mm. Autonomy: over 6 hours at medium intensity (X-LED<sup>3</sup>). Charging modes: with solar panel (12h), with external USB power supply (not included) or from PC USB port (5h).



v 1.4.0 - OPTIKA reserves the right to make corrections, modifications, enhancements, improvements and other changes to its products at any time without notice.

---

## Headquarters and Manufacturing Facilities

---

**OPTIKA® S.r.l.** Via Rigla, 30 - 24010 Ponteranica (BG) - ITALY - Tel.: +39 035.571.392 - [info@optikamicroscopes.com](mailto:info@optikamicroscopes.com)

## Optika Sales branches

---

**OPTIKA® Spain** [spain@optikamicroscopes.com](mailto:spain@optikamicroscopes.com)  
**OPTIKA® China** [china@optikamicroscopes.com](mailto:china@optikamicroscopes.com)  
**OPTIKA® India** [india@optikamicroscopes.com](mailto:india@optikamicroscopes.com)

**OPTIKA® USA** [usa@optikamicroscopes.com](mailto:usa@optikamicroscopes.com)  
**OPTIKA® Central America** [camerica@optikamicroscopes.com](mailto:camerica@optikamicroscopes.com)



**OPTIKA<sup>®</sup>**  
M I C R O S C O P E S  
I T A L Y

B-810 & B-1000



Research Lab Upright Microscopes

# ② B-810/B-1000 - Research Lab Upright Microscopes



# B-810/B-1000 - Research Lab Upright Microscopes

2

Laboratory

OPTIKA Microscopes, thanks to the long experience achieved in microscopy development, has conceived the new B-1000: a major leap in our technological offer. As a flagship instrument, B-1000 originates from customer most demanding feedbacks and needs. Its modularity and versatility will allow to find the perfect place in any clinical or basic research laboratory. All controls are easily accessible and comfortable also for extended periods of observation.

B-1000 is built on IOS Infinity Corrected optical system, which gives both top-notch optical performances, and the possibility to extend your instrument with the broad range of accessories and modules. X-LED illumination is the best solution to have pure white light, very intense even at higher magnification, and optimum power efficiency given by solid state source.

If you are looking for our best solution to your present and future professional demands, B-1000 is the answer.



Highest category of optical equipment among our product range guarantees a sharp and clear view in any situation, while top level mechanical design offers sturdiness and long lifetime.



# B-810/B-1000 - Research Lab Upright Microscopes



# B-810/B-1000 - Research Lab Upright Microscopes

2

Laboratory

## Solid Stand – Extra Stability

A completely new design and a die-cast aluminum stand offer solidity and durability, even for the most demanding laboratory use.

This new microscope can seamlessly be upgraded with many attachments that extend its field of use.

## X-LED White Illumination

X-LED illumination system is based on a pure white high-efficiency LED and a special optics. It guarantees constant color temperature, no heat, and an extreme electrical consumption efficiency. The whole system is pre-aligned and boasts a lifetime of 50,000 hours.

## X-LED benefits

Powerful pure white LED illumination, ideal for brightfield, darkfield and phase contrast applications. Constant color temperature through all the intensity levels. No heat generation, avoiding damage of the specimen. Factory pre-centering assures uniform illumination over the field of view, yet providing perfect Koehler alignment. Very long lifetime and high power efficiency.

## Light under control

Intelligent control of the microscope illumination: the "AUTO-OFF" function automatically switches the light off after a user-selectable time period. "BOOST" gives an extra high level of illumination for light-demanding applications. "AUTO" allows to store an illumination level, and to maintain it throughout the inspection.

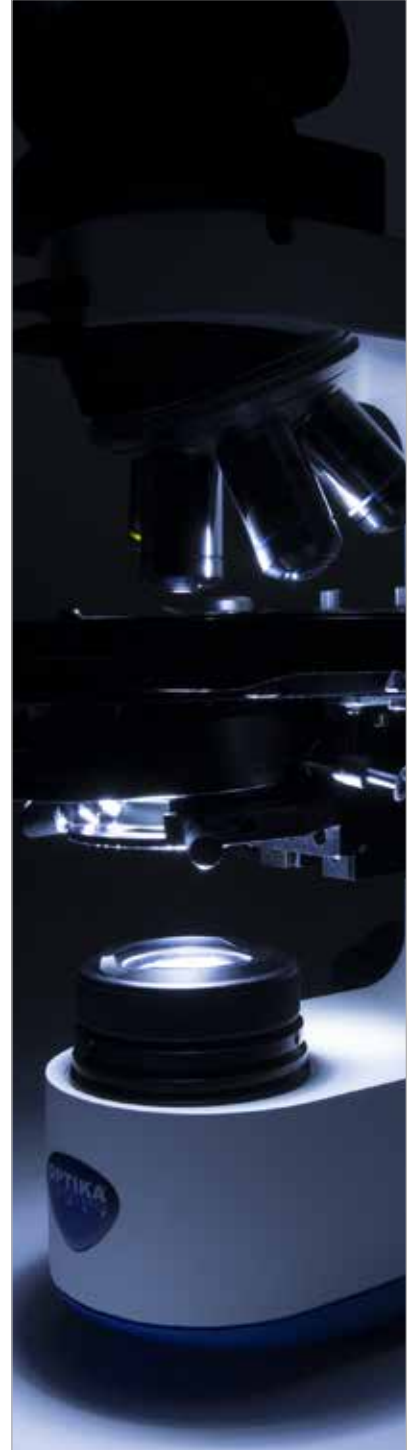

## Ergonomics

Low position focus and stage controls allow a fast and comfortable operation. Frequently used controls as light intensity adjustment and diaphragm are also placed in the lower part of the stand and enable operation without having to take the eyes off the specimen. All optical heads are equipped with high-point eyepieces and dioptic adjustment, for the best viewing experience.

# ② B-810/B-1000 - Research Lab Upright Microscopes



## **Modularity – Build your own solution**

Many worlds in one instrument. Modularity allows to build the desired solution (brightfield, darkfield, phase contrast, material science, fluorescence, motorized automation and so on). B-1000 has the flexibility to help your work the best way.

## **Comfortable Stage**

Refined belt-driven stage, with a wide working surface and a highly precise XY movement.

## **High Quality IOS Optical System**

Infinity corrected optical system, based on planachromatic, fluorite and semi-apochromatic objectives, designed to give sharp and clear images, both for the user and the digital camera. Quintuple and sextuple nosepieces give the flexibility to build the objectives that best suits your needs. The system is completed with wide field, high-point eyepieces, with a field number of 24mm.

## **Ready for Digital Imaging**

Range of adapters can accommodate for C-mount digital cameras, as well as reflex cameras. Focus adjustment gives perfectly clear digital images. Our cameras include specific software for capturing, measuring, marking and storing your images. Pro View software allows to perform image acquisition, post-processing, measurements and storage of your images. User can save a preset for later work, or even create a multi-focus composition.



# B-810/B-1000 - Research Lab Upright Microscopes

2

Laboratory

## Remote-controlled microscope

The stage can be remote-controlled through a dedicated software: X, Y, Z axes, as well as nosepiece, can be moved with a single click. Communication protocol is available for interfacing with custom software, such as automated analysis or autofocus.



**X-Y-Z motorized stage**  
**Motorized nosepiece**



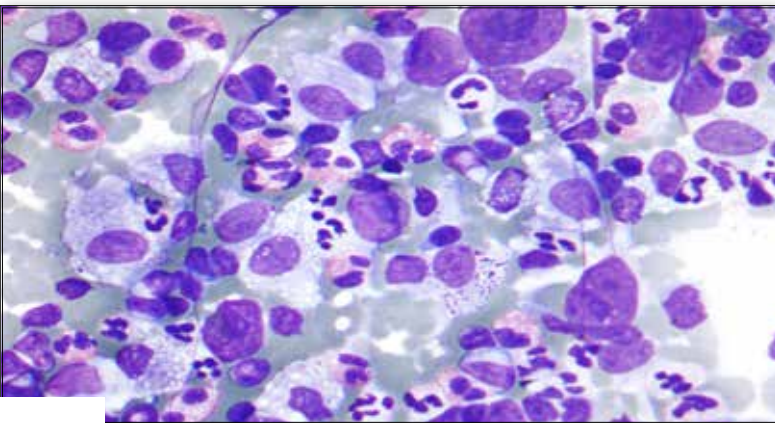

## Pathology / Cytology

Since B-810 / B-1000 use white LED illumination, they can maintain the same color temperature even if the brightness is changed. "AUTO" function automatically adjusts the light intensity when the objective is changed or the aperture diaphragm is set to a different value.

These features, along with motorized stage and ergonomic controls, make your workflow easier.

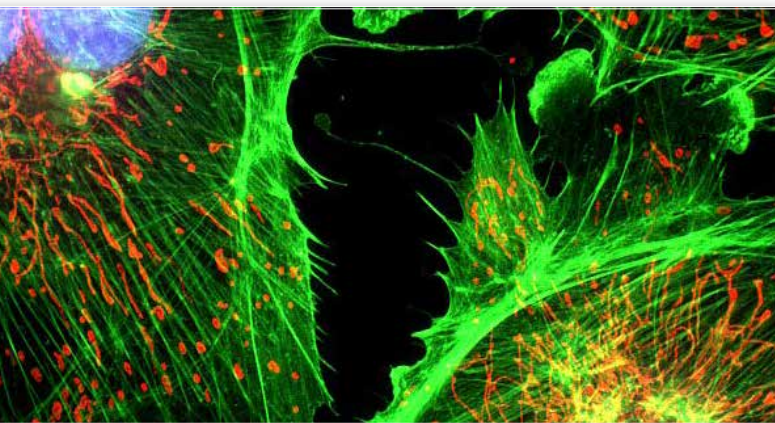

## Fluorescence Microscopy

A new attachment for epi-fluorescence provides the ultimate solution in the field of fluorescence diagnostic. Vibration-free six positions filter wheel with shutter, field and aperture diaphragms offer all you need for a complete analysis. Custom filtersets are available and mounted on request. For application where efficiency, rapidity and ease of use are crucial, this model offers also a LED epi-fluorescence attachment, with very high power standard illuminators.



## Phase Contrast Microscopy

The bright LED illuminator brings a comfortable view in phase contrast with all magnifications. Universal wheel condenser allows to quickly switch between brightfield, darkfield and phase contrast.

Ideal for clinical laboratories or fibers (e.g. asbestos) analysis.



## Darkfield Microscopy

Ideal for observing blood cells, diatoms, small insects, bone, fibers, unstained bacteria, yeast, protozoa, mineral and chemical crystals, colloidal particles, dust-count specimens, and thin sections of polymers and ceramics.

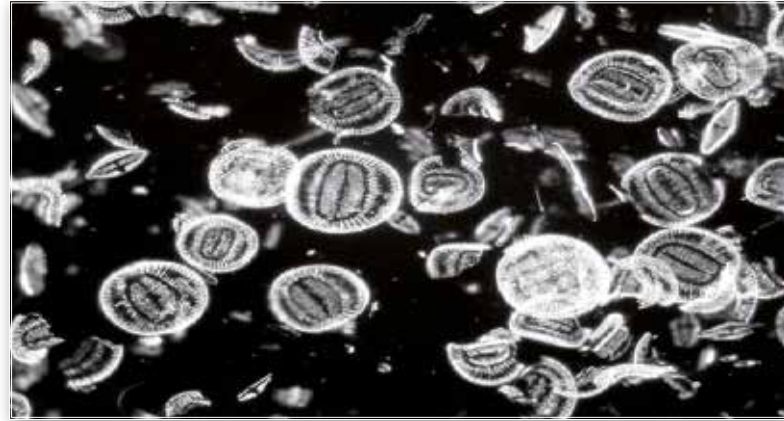

## Material Science

A new attachment designed specifically for metallographic inspection, with dedicated objectives set, for the most complete epi-illumination analysis: brightfield, darkfield and polarizing view observations.

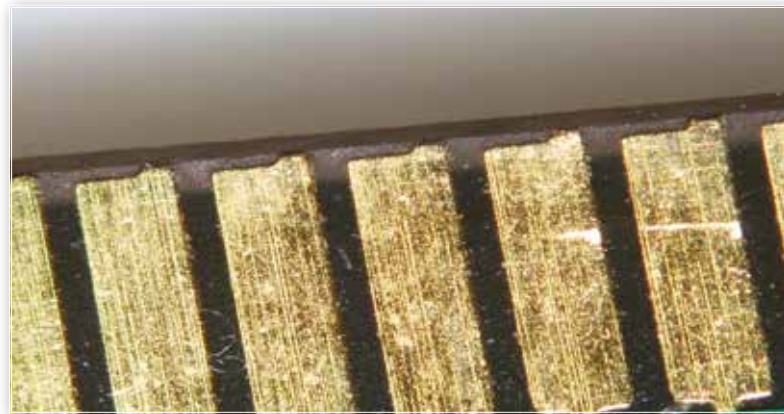

## Polarizing Microscopy

Polarized light microscopy is used in geological applications or also for both natural and industrial minerals, composites such as concretes, ceramics, mineral fibers and polymers, and crystalline or biological molecules such as DNA, starch, wood and urea.

Attachments for a full polarization analysis are available (both for transmitted and incident light), so it's possible to look at color fringes right away.

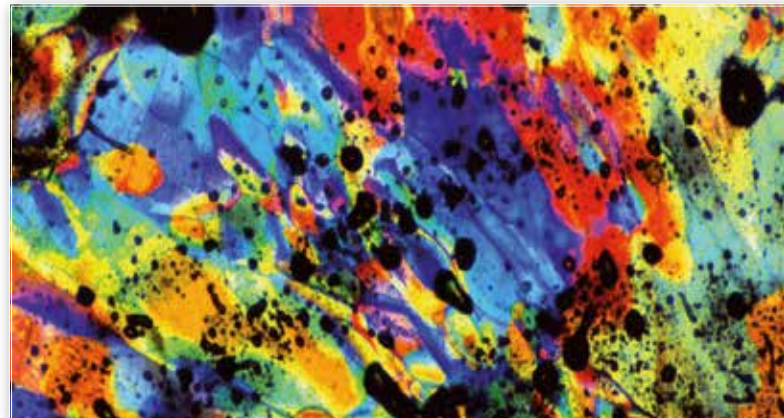

# B-810/B-1000 - Design and Production

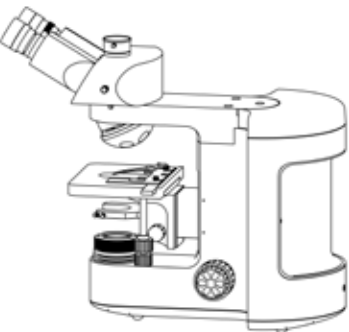
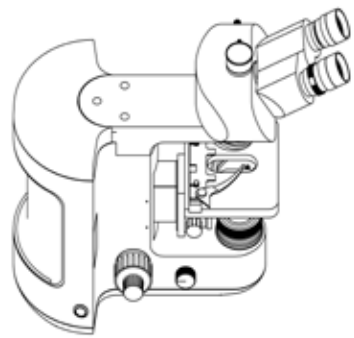
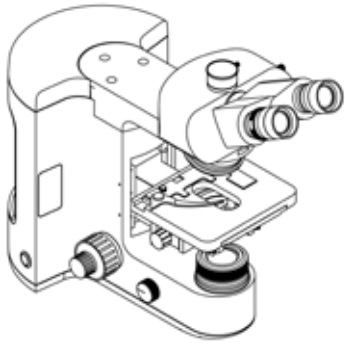
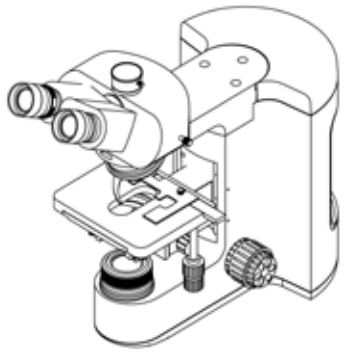

# B-810/B-1000 - Design and Production

**OPTIKA** workshop provides the facilities for precise and reliable optomechanical manufacturing, essential for this kind of instruments.

CNC machining department, equipped with 5-axis milling machine and lathe.



Die-cast stands ready to be processed.



Work in progress inside the milling machine.



Microscope stands exiting from the internal varnishing facility.



All processes are carefully monitored through the application of **ISO 9001 Quality System standards**.

# ② B-810/B-1000 - Components

## Eyepieces

Laboratory



### M-1001

PL10x/22 eyepieces (pair), high eyepoint, with rubber cup (retractable)



### M-1002

PL10x/24 eyepieces (pair), high eyepoint, with rubber cup (retractable); for B-1000 only



### M-1003

PL15x/16 eyepieces (pair), high eyepoint



### M-781

PL10x/22 eyepiece, high eyepoint, with micrometric scale (10mm/100um) & rubber cup (retractable)



### AA-01

12.5x/18 eyepieces (pair), high eyepoint, with dioptic adjustment, one with W&B graticule for Asbestos



### M-1004.N

Centering telescope



## Heads



### M-1010

Trinocular head, two positions (100/0, 50/50) for B-1000



### M-1011

Trinocular head, three positions (100/0, 50/50, 0/100) for B-1000



### M-1012

Binocular ERGO head for B-1000



### M-1013

Trinocular ERGO head, two positions (100/0, 50/50) for B-1000



### M-1188

Trinocular head, single position (50/50) for B-810



## ② B-810/B-1000 - Components

### Bodies



#### M-1187

Main body with focus system and X-LED<sup>3</sup> illumination for B-810



#### M-1021B

Main body with focus system and X-LED<sup>8</sup> illumination, for general purposes for B-1000



#### M-1021M

Main body with focus system and X-LED<sup>8</sup> illumination, for metallurgical model for B-1000



#### M-1022M

Main body with focus system, for metallurgical model with incident light only; for B-1000



#### M-1156

Upgrade (controller) for any kind of motorization (stage, Z-axis, nosepiece, or all of them together); for B-1000

#### M-1149

Motorization of Z-axis for B-1000

## Nosepieces



### M-1040

Quintuple reversed nosepiece, for RMS objectives; for B-810



### M-1041

Sextuple reversed nosepiece, for RMS objectives; for B-810



### M-1042

Sextuple reversed nosepiece, for RMS objectives with DIC slot; for B-1000



### M-1043

Sextuple motorized reversed nosepiece, for RMS objectives with DIC slot; for B-1000



### M-1044

Quintuple reversed nosepiece, with centrable positions for POL objectives; for B-1000



### M-1045

Quintuple reversed nosepiece for darkfield MET objectives, with 3 adapter rings for RMS objectives; for B-1000



### M-1046

Quintuple motorized reversed nosepiece for darkfield MET objectives, with 3 adapter rings for RMS objectives; for B-1000



# 2 B-810/B-1000 - Components

## W-PLAN Objectives

Laboratory



### Plan Objectives - IOS W-PLAN Series



- M-1049** IOS W-PLAN 2x/0.08
- M-1125** IOS W-PLAN 4x/0.10
- M-1126** IOS W-PLAN 10x/0.25
- M-1127** IOS W-PLAN 20x/0.40
- M-1128** IOS W-PLAN 40x/0.65
- M-1129** IOS W-PLAN 60x/0.80
- M-1130** IOS W-PLAN objective 100x/1.25 (oil)
- M-1130.1** IOS W-PLAN objective 100x/1.25 (Iris)

### Plan Objectives - IOS W-PLAN PH Series

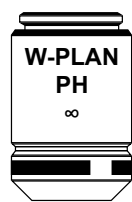

- M-1120.N** IOS W-PLAN PH 10x/0.25
- M-1121.N** IOS W-PLAN PH 20x/0.40
- M-1122.N** IOS W-PLAN PH 40x/0.65
- M-1123.N** IOS W-PLAN PH 100x/1.25 (oil)

### Plan Semi-APO Objectives - IOS W-PLAN F Series



- M-1060** IOS W-PLAN F 4x/0.13
- M-1061** IOS W-PLAN F 10x/0.30
- M-1062** IOS W-PLAN F 20x/0.50
- M-1063** IOS W-PLAN F 40x/0.75
- M-1064** IOS W-PLAN F 100x/1.30 (oil)

### Plan Objectives - IOS U-PLAN POL Series



- M-1080** IOS U-PLAN POL 4x/0.10
- M-1081** IOS U-PLAN POL 10x/0.25
- M-1081.5** IOS U-PLAN POL 20x/0.45
- M-1082** IOS U-PLAN POL 40x/0.65
- M-1083** IOS U-PLAN POL 60x/0.85

### Plan Objectives - IOS LWD W-PLAN MET Series



- M-1099** IOS LWD W-PLAN MET 2.5x/0.08 (with depolarizer)

### Plan Objectives - IOS LWD W-PLAN MET BD Series



- M-1109** IOS LWD W-PLAN MET BD 5x/0.12
- M-1110** IOS LWD W-PLAN MET BD 10x/0.25
- M-1111** IOS LWD W-PLAN MET BD 20x/0.40
- M-1112** IOS LWD W-PLAN MET BD 40x/0.60
- M-1113** IOS LWD W-PLAN MET BD 50x/0.75
- M-1114** IOS LWD W-PLAN MET BD 100x/0.80 (dry)



## U-PLAN Objectives



### Plan Semi-APO Objectives - **IOS U-PLAN F Series**



- M-1075** IOS U-PLAN F 4x/0.13
- M-1076** IOS U-PLAN F 10x/0.30
- M-1077** IOS U-PLAN F 20x/0.50
- M-1078** IOS U-PLAN F 40x/0.75
- M-1079** IOS U-PLAN F 100x/1.30 (oil)

### Plan APO Objectives - **IOS U-PLAN APO Series**



- M-1301** IOS U-PLAN APO 2x/0.08
- M-1302** IOS U-PLAN APO 4x/0.13
- M-1303** IOS U-PLAN APO 10x/0.40
- M-1304** IOS U-PLAN APO 20x/0.75
- M-1305** IOS U-PLAN APO 40x/0.95
- M-1306** IOS U-PLAN APO 60x/0.90
- M-1307** IOS U-PLAN APO 100x/1.35

### Plan Semi-APO Objectives - **IOS U-PLAN F PH Series**



- M-1310** IOS U-PLAN F PH 4x/0.13
- M-1311** IOS U-PLAN F PH 10x/0.40
- M-1312** IOS U-PLAN F PH 20x/0.75
- M-1313** IOS U-PLAN F PH 40x/0.95
- M-1314** IOS U-PLAN F PH 60x/0.90
- M-1315** IOS U-PLAN F PH 100x/1.35

*M-1157 universal condenser required*

### Plan Objectives - **IOS LWD U-PLAN POL Series**

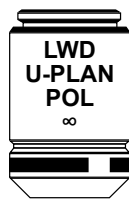

- M-1090** IOS LWD U-PLAN POL 5x/0.15
- M-1091** IOS LWD U-PLAN POL 10x/0.30
- M-1092** IOS LWD U-PLAN POL 20x/0.45
- M-1093** IOS LWD U-PLAN POL 50x/0.55

### Plan Objectives - **IOS LWD U-PLAN MET Series**



- M-1100** IOS LWD U-PLAN MET 5x/0.15
- M-1101** IOS LWD U-PLAN MET 10x/0.30
- M-1102** IOS LWD U-PLAN MET 20x/0.45
- M-1103** IOS LWD U-PLAN MET 50x/0.55
- M-1104** IOS LWD U-PLAN MET 100x/0.80 (dry)

### Plan Semi-APO Objectives - **IOS LWD U-PLAN F MET Series**



- M-1171** IOS LWD U-PLAN F MET 5x/0.15
- M-1172** IOS LWD U-PLAN F MET 10x/0.30
- M-1173** IOS LWD U-PLAN F MET 20x/0.50
- M-1174** IOS LWD U-PLAN F MET 50x/0.80
- M-1175** IOS LWD U-PLAN F MET 100x/0.90 (dry)

### Plan Objectives - **IOS LWD U-PLAN MET BD (Darkfield) Series**

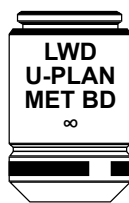

- M-1094** IOS LWD U-PLAN MET BD 5x/0.15
- M-1095** IOS LWD U-PLAN MET BD 10x/0.30
- M-1096** IOS LWD U-PLAN MET BD 20x/0.45
- M-1097** IOS LWD U-PLAN MET BD 50x/0.55
- M-1098** IOS LWD U-PLAN MET BD 100x/0.80 (dry)

### Plan Semi-APO Objectives - **IOS LWD U-PLAN F MET BD Series**

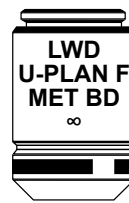

- M-1180** IOS LWD U-PLAN F MET BD 5x/0.15
- M-1181** IOS LWD U-PLAN F MET BD 10x/0.30
- M-1182** IOS LWD U-PLAN F MET BD 20x/0.50
- M-1183** IOS LWD U-PLAN F MET BD 50x/0.80
- M-1184** IOS LWD U-PLAN F MET BD 100x/0.90 (dry)

# ② B-810/B-1000 - Components

## Stages



**M-1140**  
Standard mechanical stage;  
175x145mm for B-1000



**M-1141**  
Rackless mechanical stage; movement  
knobs with friction adjustment control;  
242x157mm; for B-1000.



**M-1143**  
MPC (Mineral Solid Surface)  
rackless mechanical stage; movement  
knobs with friction adjustment control;  
242x157mm; for B-1000.



**M-1148**  
Metallurgical stage with glass, for  
metallurgical model; 175x145mm; for  
B-1000



**M-1190**  
Rackless mechanical stage;  
220x149mm; for B-810



**M-1143.1**  
MPC (Mineral Solid Surface) rackless  
mechanical stage; 220x149mm; for  
B-810



## Stages



**M-1145 + M-1146**  
Rotating Stage, centrable + attachable XY stage; dia. 172mm; for B-1000



**M-1147**  
Motorized mechanical stage; 242x157mm; for B-1000

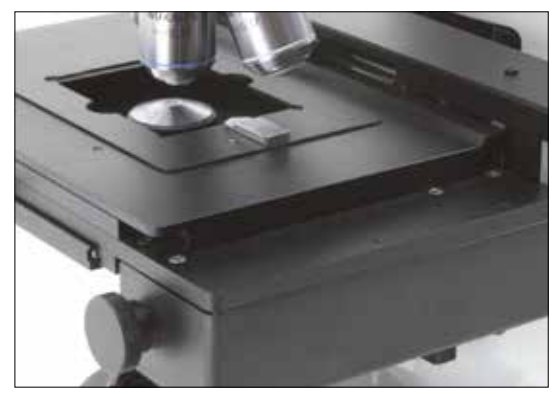

**M-1144**  
Heating stage, with digital temperature controller; 175x145mm; for B-1000



**M-1190H**  
Heating stage, with digital temperature controller; 220x149mm; for B-810



## ② B-810/B-1000 - Components

### Condensers



#### M-1189

0.90 N.A. swing-out condenser for B-810



#### M-1150

0.90 N.A. swing-out condenser for B-1000



#### M-1191

1.2 N.A. swing-out condenser for B-810



#### M-1151

1.2 N.A. swing-out condenser for B-1000



#### M-1155

0.9/0.25 N.A. swing-out condenser (to be used with objective M-1049) for B-1000



#### M-1154

0.70 N.A. swing-out MET condenser for B-1000



## Condensers

**M-1157** 8-Position universal condenser for B-1000



**Parts for the universal condenser M-1157**

**M-1205** Top lens 0.2 N.A.

**M-1206** Top lens 0.9 N.A.

**M-1207** Top lens 1.4 N.A.

**M-1208** DIC 10x prism

**M-1209** DIC 20x prism

**M-1210** DIC 40x/60x prism

**M-1212** 10x/20x phase ring

**M-1213** 40x/60x phase ring

**M-1214** 100x phase ring

**M-1215** 4x phase ring

**M-1216** Darkfield stop (dry)

**M-1217** Darkfield stop (oil)

**M-1153**

0.90 N.A. swing-out POL condenser for B-1000



**M-618**

Darkfield condenser for dry objectives for B-1000



**M-185**

Darkfield condenser for dry objectives for B-810



**M-1124.NO**

Phase contrast condenser with insert slide 10x/20x-40x for B-810



**M-1124**

Phase contrast condenser with insert slide 10x/20x-40x for B-1000



**M-1152.NO**

Phase contrast condenser 10x, 20x, 40x, 100x, BF, DF for B-810



**M-1152.N**

Phase contrast condenser 10x, 20x, 40x, 100x, BF, DF for B-1000



# ② B-810/B-1000 - Components

## Attachments

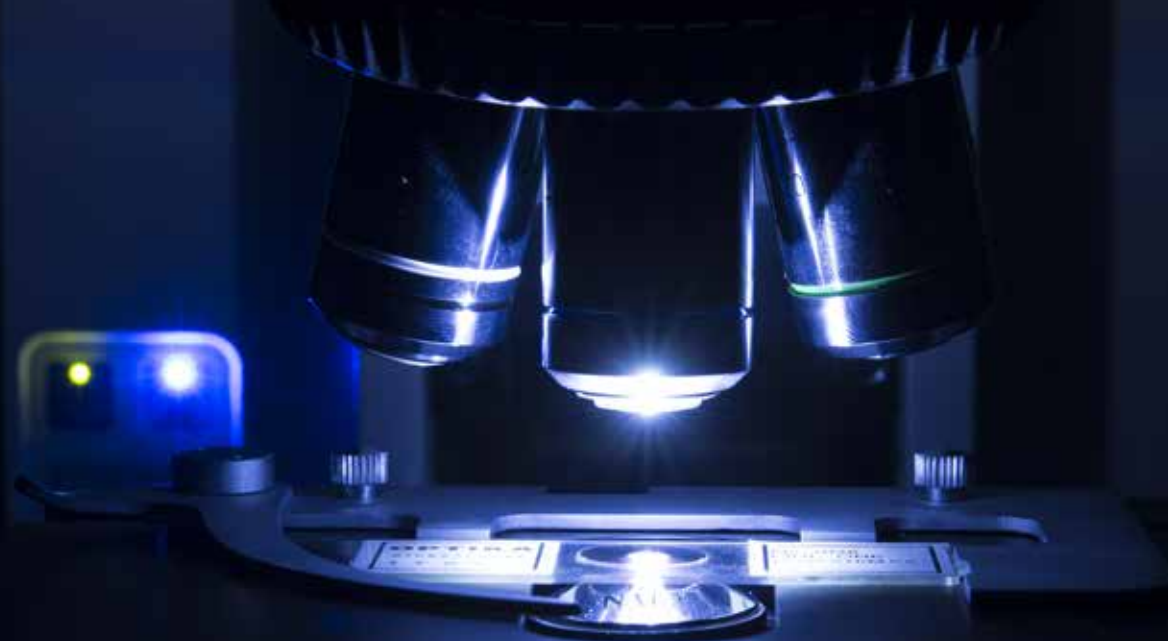

### Fluorescence attachments

#### M-1031

4-position LED Fluorescence attachment, with standard Blue and Green filtersets (FITC & TRITC); for B-1000



#### M-1032

6-position HBO Fluorescence attachment, with standard Blue and Green filtersets (FITC & TRITC). With Aperture & Field Diaphragms; for B-1000.



### Polarizing attachments

#### M-1033

Bertrand lens with analyzer and slot for sliders (with Lambda, 1/4 Lambda and Quartz Edge); for B-1000



#### M-1034

8W X-LED incident polarizing attachment. With Aperture & Field Diaphragms; for B-1000



### ALC attachments

#### M-1030

Automatic Light Control (ALC) system for B-1000



## Attachments



## Metallurgical attachment

### M-1035

Metallurgical attachment, 100 W Halogen. Equipped with Polarizer and rotating Analyzer. With Aperture & Field Diaphragms. 2 empty slots for extra filters; for B-1000.



### M-1036

Metallurgical attachment, 100 W Halogen. Equipped with Polarizer and rotating Analyzer. With Aperture & Field Diaphragms. 2 empty slots for extra filters; for B-1000.



# B-810/B-1000 - Components

## Discussion Bridges for B-1000



**M-1163**



**M-1159**



**M-1160**



**M-1161**



**M-1162**

**M-1159**  
Discussion Bridge with 1 extra head.  
Face-to-Face type

**M-1160**  
Discussion Bridge with 1 extra head.  
Side-by-Side type

**M-1161**  
Discussion Bridge with 2 extra heads

**M-1162**  
Discussion Bridge with 4 extra heads

**M-1163**  
Discussion Bridge with 9 extra heads

All Discussion Bridges are equipped with extra heads with WF10x/20mm eyepieces



## Application Sets

### Koehler DIC transmitted

- M-550** - Interferential green filter IF550.
- M-190P** - Polarizer for transmitted light.
- M-1201** - Analyzer for transmitted light.
- M-1202** - DIC prism for transmitted light.



Usable objective series: **IOS W-PLAN F**, **IOS U-PLAN F**. (See page 168)

### Transmitted Koehler DIC combined with Fluo HBO

- M-550** - Interferential green filter IF550.
- M-190P** - Polarizer for transmitted light.
- M-1203** - Analyzer for reflected light.
- M-1202** - DIC prism for transmitted light.



Usable objective series: **IOS W-PLAN F**, **IOS U-PLAN F**. (See page 168)

### Nomarski DIC transmitted

- M-1157** - 8-Position universal condenser.
- M-1206** - Top lens 0.9 N.A.
- M-1208** - DIC 10x prism for universal condenser.
- M-1209** - DIC 20x prism for universal condenser.
- M-1210** - DIC 40x/60x prism for universal condenser.
- M-1201** - Analyzer for transmitted light.
- M-1202** - DIC prism for transmitted light.



Usable objective series: **IOS U-PLAN F**, **IOS U-PLAN APO**, **IOS U-PLAN F PH**. (See page 168)

### Transmitted Nomarski DIC combined with Fluo HBO

- M-1157** - 8-Position universal condenser.
- M-1206** - Top lens 0.9 N.A.
- M-1208** - DIC 10x prism for universal condenser.
- M-1209** - DIC 20x prism for universal condenser.
- M-1210** - DIC 40x/60x prism for universal condenser.
- M-1203** - Analyzer for reflected light.
- M-1202** - DIC prism for transmitted light.



Usable objective series: **IOS U-PLAN F**, **IOS U-PLAN APO**, **IOS U-PLAN F PH**. (See page 168)

### Nomarski DIC reflected for metallurgical appl.

- M-870** - DIC prism for metallurgical reflected light.



Usable objective series: **IOS LWD U-PLAN F MET Series**  
**IOS LWD U-PLAN F MET BD Series**.

See page 168

### GOUT analysis kit

- M-1037** - GOUT analysis kit



# B-810 - Brightfield & Phase Contrast Microscope

B-810 is the result of the long experience gathered by OPTIKA Microscopes in the field of light microscopy, offering an extremely valuable product for routine and research laboratory brightfield & phase contrast applications.

Ergonomic design for comfortable long-term use and smooth operation with minimal movements meets the concept of modularity, to offer a the possibility to create a tailored version and match all the personal requirements.

It is qualified as an particularly performing and robust solution, considering the field of view of 22 mm, the state-of-the-art, exclusive **X-LED<sup>3</sup>** lighting source (3.6 W) and the sturdy dye-cast frame for high stability combined with a wide variety of heads, objectives and condensers to get the most out of a microscope.



# B-810 - Configuration Chart

Build the microscope that suites your needs by choosing among the components



## ② B-1000BF - Brightfield Microscope

The modular OPTIKA B-1000 helps you working in a comfortable way during extended periods of use and let you perform reliable, accurate and rapid diagnosis benefiting from modularity, which gives the chance to create customized configurations tailored on customer needs.

Versatile, robust, durable and sturdy, B-1000 offers premium quality optics (including Semi-Apo objectives), the state-of-the-art, exclusive **X-LED<sup>®</sup>** (8 W) illumination system, designed by OPTIKA and the Koehler diaphragm. B-1000 gives multiple options as manual or motorized configuration, with the possibility of **ALC** (Automatic Light Control) and a variety of objectives, stages and condensers.



22



24



# B-1000BF - Configuration Chart

Build the microscope that suites your needs by choosing among the components

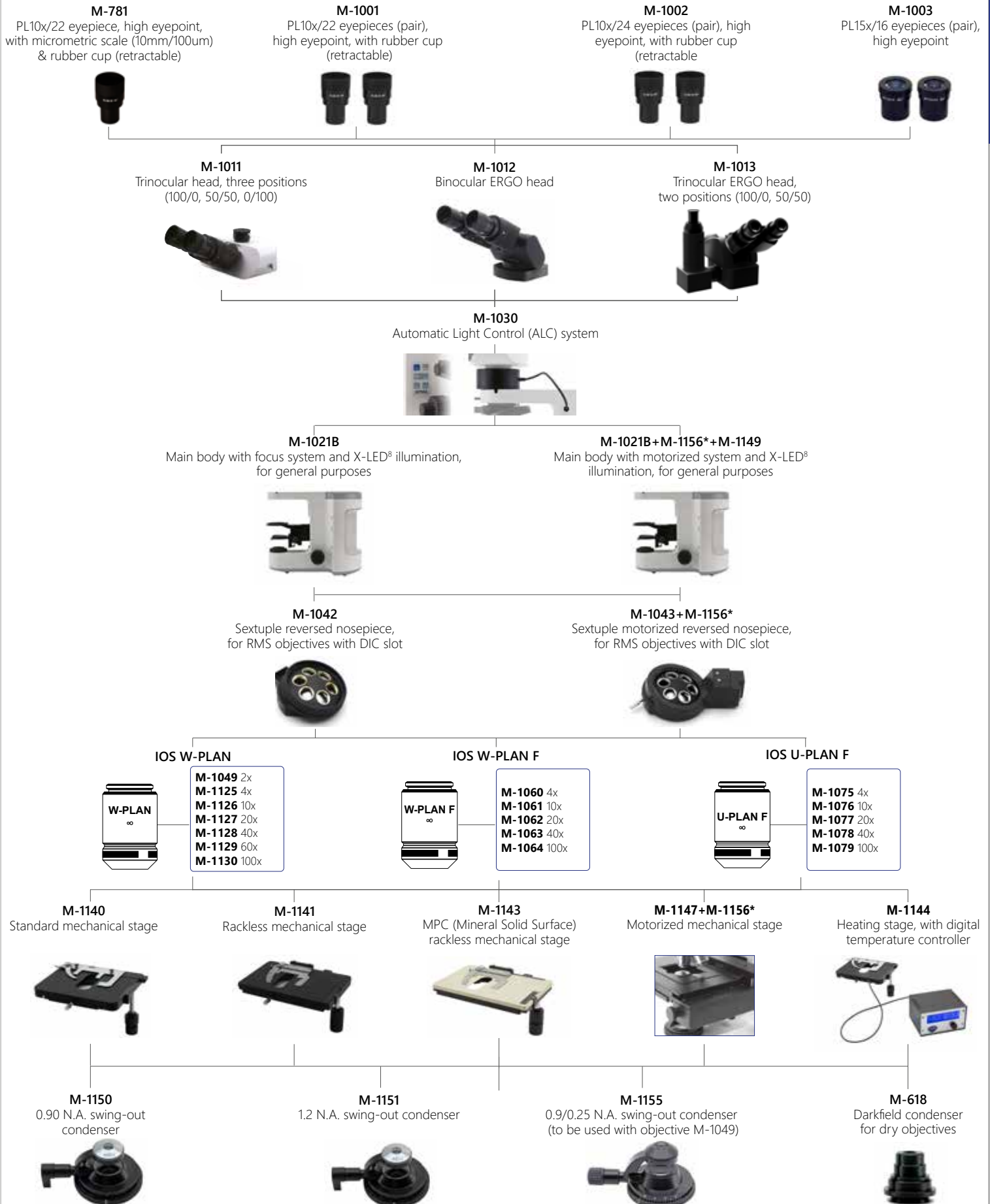

\* Code M-1156 must be added only **once** for any motorized configuration

# B-1000PH - Phase Contrast Microscope

The modular OPTIKA B-1000 is available in phase contrast and helps you working in a comfortable way during extended periods of use performing reliable, accurate and rapid diagnosis benefiting from modularity, which gives the chance to create customized configurations tailored on customer needs. Versatile, robust, durable and sturdy, B-1000 offers premium quality optics, the state-of-the-art, exclusive **X-LED<sup>8</sup>** (8 W) illumination system, designed by OPTIKA and the Koehler diaphragm. B-1000 gives multiple options as manual or motorized configuration, with the possibility of **ALC** (Automatic Light Control) and a variety of objectives, stages and condensers.



22



24



# B-1000PH - Configuration Chart

Build the microscope that suites your needs by choosing among the components



\* Code M-1156 must be added only **once** for any motorized configuration

# 2 B-1000FL-HBO - HBO Fluorescence Microscope

The modular OPTIKA B-1000 can stand a HBO fluorescence attachment, helping you working in a comfortable way during extended periods of use and performing reliable, accurate and rapid diagnosis benefiting from modularity, which gives the chance to create customized configurations tailored on customer needs. Versatile, robust, durable and sturdy, B-1000 offers premium quality optics (including Semi-Apo objectives), the state-of-the-art, exclusive **X-LED<sup>8</sup>** (8 W) illumination system, designed by OPTIKA and the Koehler diaphragm.

B-1000 gives multiple options as manual or motorized configuration, with a variety of objectives, stages and condensers.

## Standard filterset

Name	Excitation filter (nm)	Dichroic mirror cut-off (nm)	Emission filter (nm)
<b>B Blue</b>	460 - 490	500	520LP
<b>G Green</b>	510 - 550	570	590LP

## Additional filterset (optional)

Name	Excitation filter (nm)	Dichroic mirror cut-off (nm)	Emission filter (nm)
<b>V (Violet)</b>	400 - 410	455	455LP
<b>UV</b>	330 - 385	400	420LP





# B-1000FL-HBO - Configuration Chart

Build the microscope that suites your needs by choosing among the components



\* Code M-1156 must be added only **once** for any motorized configuration

# 2 OPTIKA B-1000FL-LED - LED Fluorescence Microscope

The modular OPTIKA B-1000 can stand a LED fluorescence attachment, helping you working in a comfortable way during extended periods of use and performing reliable, accurate and rapid diagnosis benefiting from modularity, which gives the chance to create customized configurations tailored on customer needs. Versatile, robust, durable and sturdy, B-1000 offers premium quality optics (including Semi-Apo objectives), the state-of-the-art, exclusive **X-LED<sup>8</sup>** (8 W) illumination system, designed by OPTIKA and the Koehler diaphragm. B-1000 gives multiple options as manual or motorized configuration, with a variety of objectives, stages and condensers.



### Innovative, LED Fluorescence

- » Recommended for routine applications
- » Cost-effective, money saving technology
- » Ready for immediate operation
- » Eliminate warm-up/cool-down times
- » Forget lamp replacement & centering

### Standard filterset

Name	Excitation filter (nm)	Dichroic mirror cut-off (nm)	Emission filter (nm)
B Blue	450 - 490	495	520LP
G Green	500 - 540	560	575LP

# B-1000FL-LED - Configuration Chart

Build the microscope that suites your needs by choosing among the components

**M-781**  
PL10x/22 eyepiece, high eyepoint,  
with micrometric scale (10mm/100um)  
& rubber cup (retractable)



**M-1001**  
PL10x/22 eyepieces (pair),  
high eyepoint, with rubber cup  
(retractable)



**M-1003**  
PL15x/16 eyepieces (pair),  
high eyepoint



**M-1011**  
Trinocular head, three positions  
(100/0, 50/50, 0/100)



**M-1012**  
Binocular ERGO head



**M-1031**  
4-position LED Fluorescence attachment,  
with standard Blue and Green filtersets (FITC & TRITC)



**M-1021B**  
Main body with focus system and X-LED<sup>®</sup>  
illumination, for general purposes



**M-1021B+M-1156\*+M-1149**  
Main body with motorized system and X-LED<sup>®</sup>  
illumination, for general purposes



**M-1042**  
Sextuple reversed nosepiece,  
for RMS objectives with DIC slot



**M-1043+M-1156\***  
Sextuple motorized reversed nosepiece,  
for RMS objectives with DIC slot



**IOS W-PLAN**



**M-1049** 2x  
**M-1125** 4x  
**M-1126** 10x  
**M-1127** 20x  
**M-1128** 40x  
**M-1129** 60x  
**M-1130** 100x

**IOS W-PLAN F**



**M-1060** 4x  
**M-1061** 10x  
**M-1062** 20x  
**M-1063** 40x  
**M-1064** 100x

**IOS U-PLAN F**



**M-1075** 4x  
**M-1076** 10x  
**M-1077** 20x  
**M-1078** 40x  
**M-1079** 100x

**M-1140**  
Standard mechanical stage



**M-1141**  
Rackless mechanical stage



**M-1143**  
MPC (Mineral Solid Surface)  
rackless mechanical stage



**M-1147+M-1156\***  
Motorized mechanical stage



**M-1144**  
Heating stage, with digital  
temperature controller



**M-1150**  
0.90 N.A. swing-out  
condenser



**M-1151**  
1.2 N.A. swing-out condenser



**M-1155**  
0.9/0.25 N.A. swing-out condenser  
(to be used with objective M-1049)



**M-618**  
Darkfield condenser  
for dry objectives



\* Code M-1156 must be added only **once** for any motorized configuration

## ② B-1000POL - Polarizing Microscope

The modular OPTIKA B-1000 is available with transmitted polarized light, helping you working in a comfortable way during extended periods of use and performing reliable, accurate and rapid diagnosis benefiting from modularity, which gives the chance to create customized configurations tailored on customer needs. Versatile, robust, durable and sturdy, B-1000 offers premium quality optics, the state-of-the-art, exclusive **X-LED<sup>8</sup>** (8 W) illumination system, designed by OPTIKA and the Koehler diaphragm.

B-1000 gives multiple options as manual or motorized configuration.



Dedicated version for transmitted  
(**X-LED<sup>8</sup>**, 8 W)  
illumination and polarization analysis.

# B-1000POL - Configuration Chart

Build the microscope that suites your needs by choosing among the components

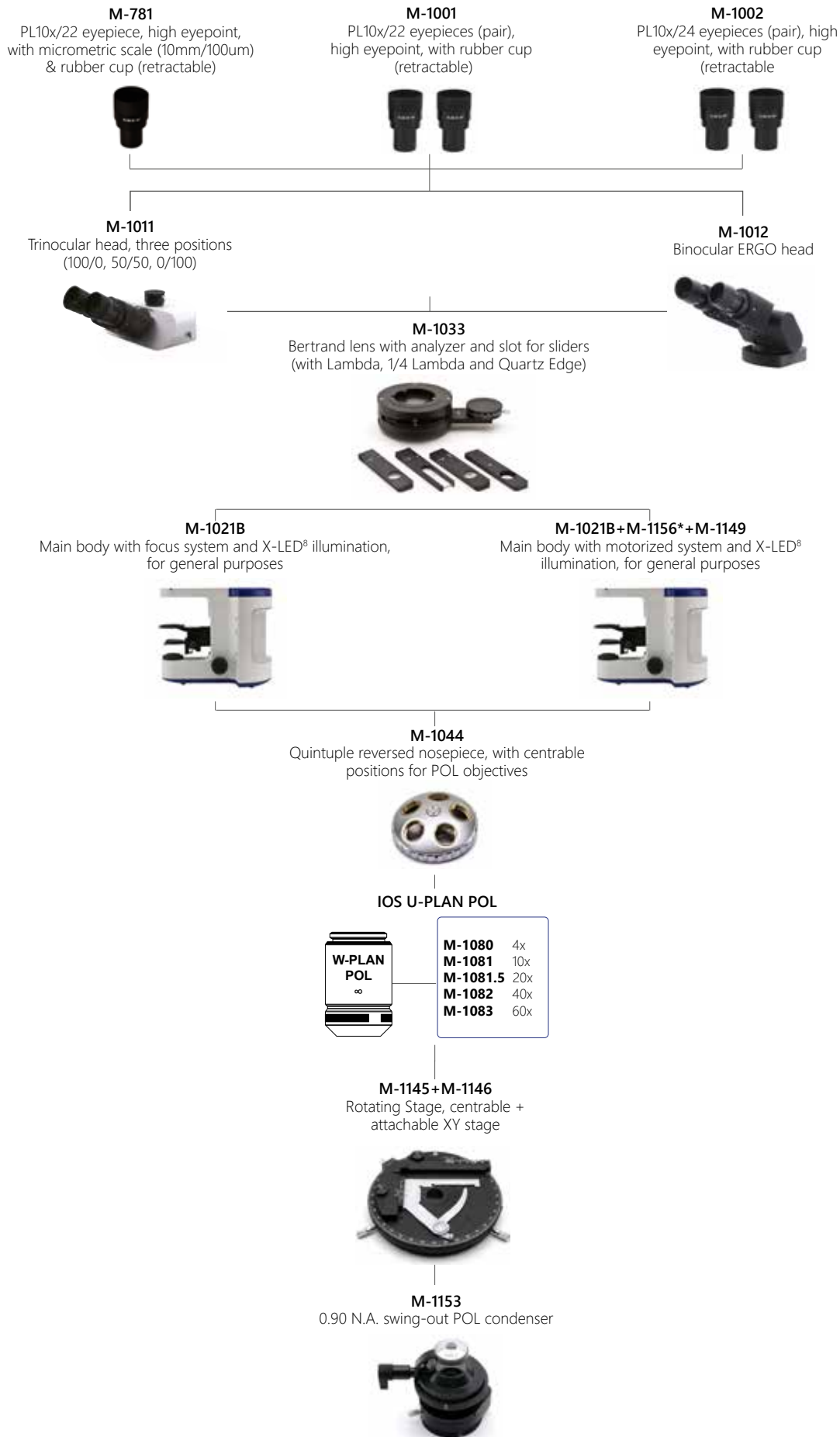

\* Code M-1156 must be added only **once** for any motorized configuration

## ② B-1000POL-I - Polarizing Microscope

The modular OPTIKA B-1000 is available with transmitted and incident polarized light, helping you working in a comfortable way during extended periods of use and performing reliable, accurate and rapid diagnosis benefiting from modularity, which gives the chance to create customized configurations tailored on customer needs. Versatile, robust, durable and sturdy, B-1000 offers premium quality optics, the state-of-the-art, exclusive **X-LED<sup>®</sup>** (8 W) illumination system, designed by OPTIKA and the Koehler diaphragm.

B-1000 gives multiple options as manual or motorized configuration.



Dedicated version for transmitted and incident illumination (**X-LED<sup>®</sup>**, 8 W)



# B-1000POL-I - Configuration Chart

Build the microscope that suites your needs by choosing among the components

**M-781**  
PL10x/22 eyepiece, high eyepoint,  
with micrometric scale (10mm/100um)  
& rubber cup (retractable)



**M-1001**  
PL10x/22 eyepieces (pair),  
high eyepoint, with rubber cup  
(retractable)



**M-1011**  
Trinocular head, three positions  
(100/0, 50/50, 0/100)



**M-1012**  
Binocular ERGO head



**M-1033**  
Bertrand lens with analyzer and slot for sliders  
(with Lambda, 1/4 Lambda and Quartz Edge)



**M-1034**  
Incident polarizing attachment



**M-1021B**  
Main body with focus system and X-LED<sup>®</sup> illumination,  
for general purposes



**M-1021B+M-1156\*+M-1149**  
Main body with motorized system and X-LED<sup>®</sup>  
illumination, for general purposes



**M-1044**  
Quintuple reversed nosepiece, with centrable  
positions for POL objectives



IOS LWD U-PLAN POL



**M-1090** 5x  
**M-1091** 10x  
**M-1092** 20x  
**M-1093** 50x

**M-1145+M-1146**  
Rotating Stage, centrable +  
attachable XY stage



**M-1153**  
0.90 N.A. swing-out POL condenser



\* Code M-1156 must be added only **once** for any motorized configuration

# B-1000MET - Metallurgical Microscope

The modular OPTIKA B-1000 is available with brightfield and darkfield incident light, helping you working in a comfortable way during extended periods of use and performing reliable, accurate and rapid diagnosis benefiting from modularity, which gives the chance to create customized configurations tailored on customer needs. Versatile, robust, durable and sturdy, B-1000 offers premium quality optics, the state-of-the-art, exclusive **X-LED<sup>®</sup>** (8 W) illumination system, designed by OPTIKA and the Koehler diaphragm. Incident light through 100 W halogen lamp or 18 W LED illumination. B-1000 gives multiple options as manual or motorized configuration.

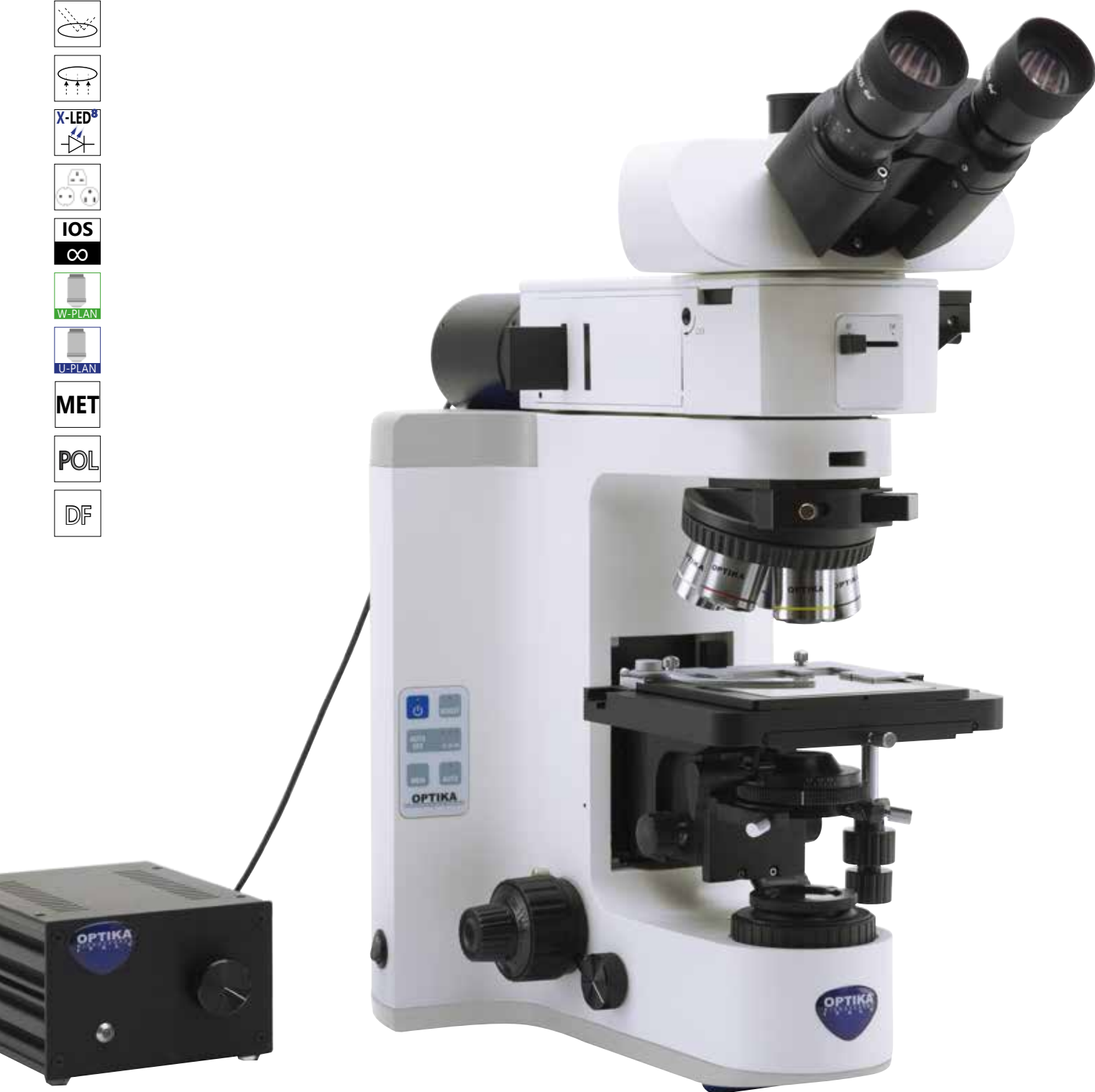



# B-1000MET - Configuration Chart

Build the microscope that suites your needs by choosing among the components



\* Code M-1156 must be added only **once** for any motorized configuration

# B-1000 Multi-Head - Discussion Microscopes

The modular OPTIKA B-1000 helps you working in a comfortable way during extended periods of use and let you perform reliable, accurate and rapid diagnosis benefiting from modularity, which gives the chance to create customized configurations tailored on customer needs.

Versatile, robust, durable and sturdy, B-1000 offers premium quality optics (including Semi-Apo objectives), the state-of-the-art, exclusive **X-LED** illumination system, designed by OPTIKA and the Koehler diaphragm. B-1000 gives multiple options as manual or motorized configuration, with a variety of objectives, stages and condensers. Ideal for discussion groups and teaching purpose for multiple observers, up to ten users simultaneously.

A three-color LED pointer facilitates the indication and identification of the object observed.



**B-1000Ti-2** - multi-head microscope for 2 users

**B-1000Ti-3** - multi-head microscope for 3 users

**B-1000Ti-5** - multi-head microscope for 5 users

**B-1000Ti-10** - multi-head microscope for 10 users



# B-1000 Multi-Head - Configuration Chart

Build the microscope that suites your needs by choosing among the components

**M-781**  
PL10x/22 eyepiece, high eyepoint, with micrometric scale (10mm/100um) & rubber cup (retractable)



**M-1001**  
PL10x/22 eyepieces (pair), high eyepoint, with rubber cup (retractable)



**M-1003**  
PL15x/16 eyepieces (pair), high eyepoint



**M-1011**  
Trinocular head, three positions (100/0, 50/50, 0/100)



**M-1012**  
Binocular ERGO head



- M-1159** - Multi-head attachment, 1 extra head (face-to-face)
- M-1160** - Multi-head attachment, 1 extra head
- M-1161** - Multi-head attachment, 2 extra head
- M-1162** - Multi-head attachment, 4 extra head
- M-1163** - Multi-head attachment, 9 extra head

**M-1021B**  
Main body with focus system and X-LED<sup>®</sup> illumination, for general purposes



**M-1021B+M-1156\*+M-1149**  
Main body with motorized system and X-LED<sup>®</sup> illumination, for general purposes



**M-1042**  
Sextuple reversed nosepiece, for RMS objectives with DIC slot



**M-1043+M-1156\***  
Sextuple motorized reversed nosepiece, for RMS objectives with DIC slot



**IOS W-PLAN PH**



- M-1120.N** 10x
- M-1121.N** 20x
- M-1122.N** 40x
- M-1123.N** 100x

**IOS W-PLAN**



- M-1049** 2x
- M-1125** 4x
- M-1126** 10x
- M-1127** 20x
- M-1128** 40x
- M-1129** 60x
- M-1130** 100x

**IOS W-PLAN F**



- M-1060** 4x
- M-1061** 10x
- M-1062** 20x
- M-1063** 40x
- M-1064** 100x

**IOS U-PLAN F**



- M-1075** 4x
- M-1076** 10x
- M-1077** 20x
- M-1078** 40x
- M-1079** 100x

**M-1140**  
Standard mechanical stage



**M-1141**  
Rackless mechanical stage



**M-1143**  
MPC (Mineral Solid Surface) rackless mechanical stage



**M-1147+M-1156\***  
Motorized mechanical stage



**M-1144**  
Heating stage, with digital temperature controller



**M-1150**  
0.90 N.A. swing-out condenser



**M-1152.N**  
Phase contrast condenser 10x, 20x, 40x, 100x, BF, DF



**M-1124**  
Phase contrast condenser with insert slide 10x-40x



**M-1151**  
1.2 N.A. swing-out condenser



**M-1155**  
0.9/0.25 N.A. swing-out condenser (to be used with objective M-1049)



**M-618**  
Darkfield condenser for dry objectives



**M-977**  
Green filter, 45mm



\* Code M-1156 must be added only **once** for any motorized configuration

# B-810/B-1000 - Accessories

## Eyecups & Eyepieces

- AA-01 12.5x/18 eyepieces (pair), high eyepoint, focusable, W&B reticle (only for B-810 & B-1000PH)  
 M-690 Eyecups (pair)  
 M-781 PL10x/22 micrometric eyepiece, high eyepoint, with rubber cup  
 M-1001 PL10x/22 eyepieces (pair), high eyepoint, with rubber cup  
 M-1002 PL10x/24 eyepieces (pair), high eyepoint, with rubber cup (only for B-1000BF, B-1000PH and B-1000POL)  
 M-1003 PL15x/16 eyepieces (pair), high eyepoint (except for B-1000POL & B-1000POL-I)

## Condensers & Filters

- M-550 Interferential green filter IF550 (except for B-810, B-1000MET, B-1000POL and B-1000POL-I)  
 M-613 Polarizing set (filters only) (except for B-1000FL-LED, B-1000MET, B-1000POL, and B-1000POL-I)  
 M-615 Lambda filter for polarizing set (except for B-1000FL-LED, B-1000MET, B-1000POL, and B-1000POL-I)  
 M-617.1NO Phase contrast set with IOS W-PLAN objective 40x (only for B-810)  
 M-617.1N Phase contrast set with IOS W-PLAN objective 40x (only for B-1000)  
 M-975 Blue filter, 45mm diameter (except for B-1000MET)  
 M-977 Green filter, 45mm diameter (except for B-1000MET)  
 M-979 Yellow filter, 45mm diameter (except for B-1000MET)  
 M-989 Frosted glass filter, 45mm diameter (except for B-1000MET)  
 M-1164 Empty fluorescence filterblock (only for B-1000FL-HBO)  
 M-1165 Fluorescence filter set V (filterblock included) (only for B-1000FL-HBO)  
 M-1166 Fluorescence filter set UV-DAPI (filterblock included) (only for B-1000FL-HBO)  
 M-ND25 Neutral density filter, 25% transmission (only for B-1000FL-HBO)

## Camera Adapters

- M-113.1 Ring adapter, 30mm (for monocular and binocular microscopes)  
 M-115 0.35x C-Mount projection lens  
 M-114 0.5x C-Mount projection lens  
 M-118 0.75x C-Mount projection lens  
 M-173 C-Mount projection lens for APS-C/full frame reflex cameras (trino)  
 M-620 0.35x focusable C-Mount adapter (biological microscopes)  
 M-620.1 0.5x focusable C-Mount adapter (biological microscopes)  
 M-620.2 0.65x focusable C-Mount adapter (biological microscopes)  
 M-620.3 1x focusable C-Mount adapter (biological & stereomicroscopes)  
 M-699 Universal adapter for C-Mount projection lens (trino)

## Miscellaneous

- 15008 Immersion oil, 10ml  
 15009 Immersion oil, 100ml  
 15104 Cleaning kit  
 AA-02 HSE-NPL Mark II phase contrast test slide, with certification (only for B-810 & B-1000PH)  
 DC-005 TNT dust cover, extra large, 820(l)x550(h) mm  
 M-005 Micrometric slide, 26x76mm, with 2 scales (1mm/100 & 10mm/100)  
 M-069 Solar charger (only for B-810)  
 M-151 HBO 100W high-pressure mercury bulb for fluorescence  
 M-151.1 HBO 100W high-pressure mercury bulb for fluorescence (OSRAM)  
 M-1004.N Centering telescope, 30mm diameter (only for B-810, B-1000PH and B-1000TI Series)  
 M-1073 Gout analysis kit  
 VP-1000 IQ/OQ/PQ manual for B-1000 series (Brightfield)  
 VP-1000MET IQ/OQ/PQ manual for B-1000 series (Metallographic)  
 VP-1000POL IQ/OQ/PQ manual for B-1000 series (Polarizing)  
 VP-810 IQ/OQ/PQ manual for B-810 series  
 VP-1000PH IQ/OQ/PQ manual for B-1000 series (Phase Contrast)  
 VP-1000FL IQ/OQ/PQ manual for B-1000 series (Fluorescence)

### M-069 - Solar charger (only for B-810)

Included battery: rechargeable – Lithium-Poly.  
 Capacity: 2600 mAh.  
 Output voltage: 5.5Vdc. – Dimensions: 120x73x10 mm.  
 Autonomy: over 6 hours at medium intensity (X-LED<sup>3</sup>).  
 Charging modes: with solar panel (12h),  
 with external USB power supply (not included)  
 or from PC USB port (5h).



### 15104 - Cleaning kit

It cleans glass quickly and effectively,  
 without leaving residue or odor.  
 Ideal for precision lens or prism cleaning.



#### How to connect the cameras to our microscopes.

Please refer to the Adapter reference list on Digital section.

v 1.4.0 - OPTIKA reserves the right to make corrections, modifications, enhancements, improvements and other changes to its products at any time without notice.

## Headquarters and Manufacturing Facilities

**OPTIKA® S.r.l.** Via Rigla, 30 - 24010 Ponteranica (BG) - ITALY - Tel.: +39 035.571.392 - info@optikamicroscopes.com

## Optika Sales branches

**OPTIKA® Spain** spain@optikamicroscopes.com  
**OPTIKA® China** china@optikamicroscopes.com  
**OPTIKA® India** india@optikamicroscopes.com

**OPTIKA® USA** usa@optikamicroscopes.com  
**OPTIKA® Central America** camerica@optikamicroscopes.com

## IM-3 Series



**Routine Lab Inverted Microscopes**

# Your Preferred Inverted Microscope for Routine

## ROUTINE IN UNIVERSITIES, LABS & INDUSTRIES

- » Wide range to fulfill specific lab requirements
- » Valuable solutions for life and material sciences
- » Compliant with several observation methods

## AN AFFORDABLE PARTNER WITH HIGH-END FEATURES

- » IOS LWD W-PLAN objectives for flat images on 22 mm FN
- » Fast, efficient investigation with no particular sample prep
- » Trinocular port with beam splitter for most light-demanding needs



## Optically Impressive

### MAINTAINING GOOD EYESIGHT

- » 10x/22 eyepieces for large specimen view
- » Comfortable rubber cup to get rid of annoying external light
- » High eye-point for glasses wearers, dioptic adjustment (left eyepiece)

### IM-3 & IOS W-PLAN: THE PERFECT COMBINATION

- » IOS Infinity corrected optical system
- » Full planarity optics on 22 mm (W-PLAN) according to ISO 19012-1
- » High-grade Semi-Apo lens available ideal for fluorescence



# An Extensive Range of Different Configurations

## OBSERVE EVEN THE MOST COMPLEX SAMPLES

- » Phase contrast lens for transparent sample examination
- » LED and HBO fluorescence available for specific purposes
- » High quality no cover glass objectives for material science

## CONCEPTUAL INNOVATION IN LED FLUORESCENCE

- » Choose the lowest operational cost, LED lifetime of 65,000 hours
- » Immediate operation, eliminating warm-up/cool-down times
- » Forget about lamp centering, adjustment and maintenance

2

Laboratory

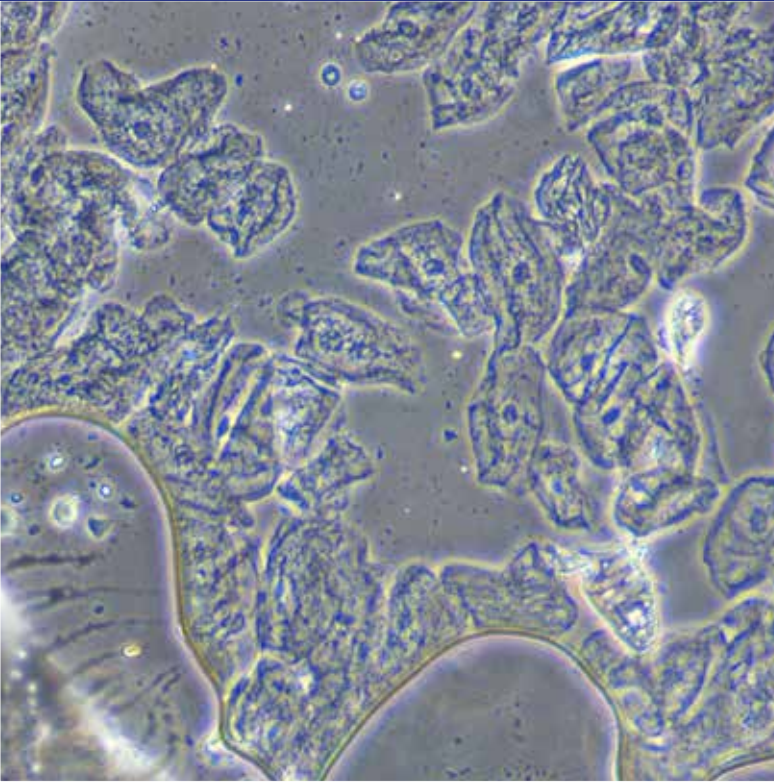

## Multiple Observation Methods

**BRIGHTFIELD**

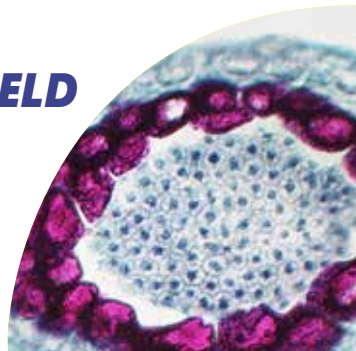

**METALLOGRAPHY**

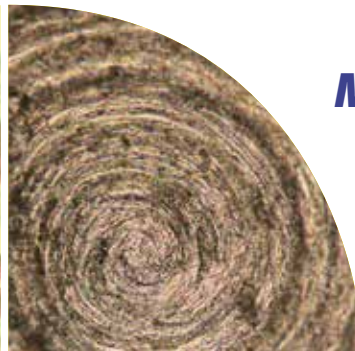

**FLUORESCENCE**



**PHASE CONTRAST**



# X-LED<sup>8</sup> - Only Available at OPTIKA

## STATE-OF-THE-ART ILLUMINATION SYSTEM

- » Uncomparable light intensity, exclusive lens & collector design
- » Constant pure-white color temperature at all intensity levels
- » Unmatched color fidelity, uniformity and brightness

## CUT ELECTRICITY BILLS BY 90%

- » Money & energy saving, 8 W
- » More efficient brightness than a 100 W halogen lamp
- » LED long lifetime (65,000 hours = 22 years at 8 hours/day usage)

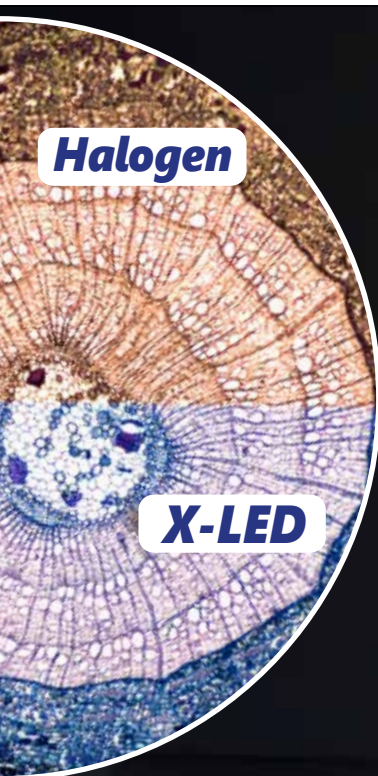

Multi-plug power supply



# Go Digital - Vivid Colors & Contrast For Stunning Images

2

## STAY CONNECTED WITH YOUR SPECIMEN, EASILY

- » Trinocular port to be always updated with the latest technology cameras, even in the future
- » Wide range of cameras matching all the needs, including the more specific ones
- » Modern C-mount focusable professional adapters for all kinds of cameras

## PROFESSIONAL IMAGE ANALYSIS

- » Multi-language software for live-view, picture and video in different file formats
- » Advanced functions for pictures processing (EDF, stitching, multi-fluorescence combine)
- » Powerful tools to perform measurements and generate custom reports

Laboratory



## IM-3 Series

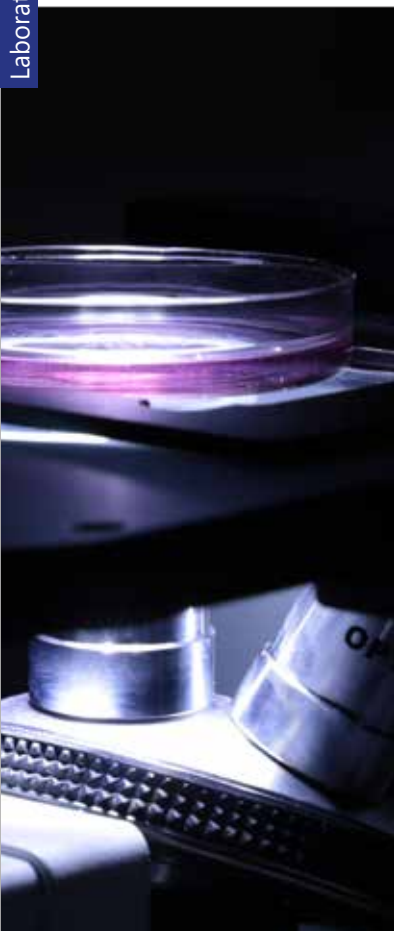

Inverted microscopes are useful for observing living cells or organisms at the bottom of a large container (e.g., a tissue culture flask) under more natural conditions than on a glass slide, as it occurs with a conventional microscope. IM-3 Series is engineered and designed to be your ideal solution for fast and reliable routine inspections, with the exclusive, state-of-the-art X-LED<sup>®</sup> illumination system. A particularly simple and ingenious optical design allows stable alignments and smooth and accurate movements. OPTIKA provides different configurations, including the innovative LED fluorescence technology for a new, enhanced experience.

### X-LED<sup>®</sup> Exclusive Lighting Source

Special technology able to double the light intensity for incomparable performance, ensuring constant pure-white colour temperature (6,300K colour temperature).

Relevant money and energy saving thanks to the incredibly low energy consumptions which allows you to cut the electricity bills by 90%!

The electric consumption (8 W only) proves the high efficiency of this system: incredibly high light intensity combined with low consumption.

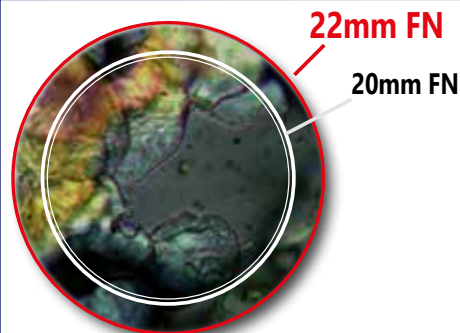

### Large Specimen View (22 mm Field Number)

The **F.O.V.** (field of view) is based on a comfortable diameter of 22 mm.

This means that an extra wide area of the sample can be inspected and allows a natural and easy view, particularly needed in a laboratory environment.

### In fluorescence we can offer several options.

According to your application and to the fluorochromes you are using, we can help you to identify the best light source.

#### Traditional, HBO Fluorescence

- » The most used and diffused method, worldwide
- » Wide spectrum range for future upgrades

#### Innovative, LED Fluorescence

- » Recommended for routine applications
- » Cost-effective, money saving technology
  - » Ready for immediate operation
  - » Eliminate warm-up/cool-down times
  - » Forget lamp replacement & centering

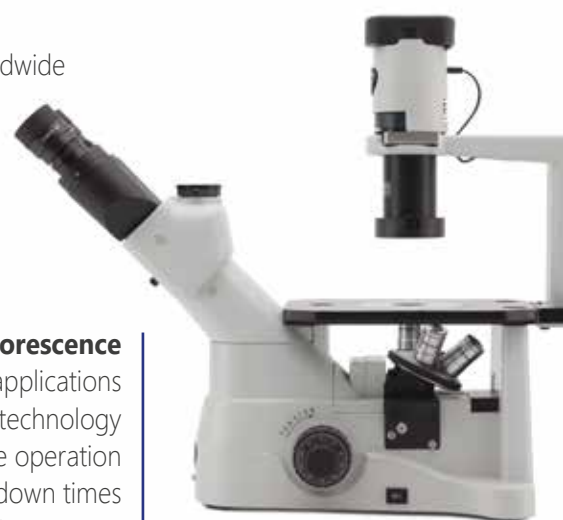

# Routine Lab Inverted Microscopes

## Get the most out of our accessories



### DESIGNED TO FACILITATE YOUR DAILY ROUTINE

- » Removable condenser to increase the working distance
- » Mechanical stage and side extensions for great comfort (as optional)
- » Different inserts available according to the container used (as optional)



**M-793.1**  
Holder for Petri diameter 38mm (M-793.2 needed).



**M-793.2**  
Holder for Terasaki and Petri diameter 65mm.



**M-793.3**  
Holder for slide and Petri diameter 54mm.



**M-793.4**  
Holder for 2+2 slides.



**M-793.5**  
Holder for metallurgical samples  
(only for IM-3MET).



**M-793.6**  
Holder for Utermöhl-Chamber (M-793.3 needed).



**M-793.7**  
Load-bearing side extension.



**M-792**  
Mechanical stage.

# IM-3 - Brightfield & Phase Contrast Microscope

IM-3 looks at the challenge of the future with confidence, offering first-class optical quality and mechanical versatility, to extend its use with several accessories. Ensuring top-level brightfield and phase contrast observation, as it comes with a set of 3 IOS LWD W-PLAN PH objectives (10x, 20x and 40x).

The high-efficiency **X-LED<sup>®</sup>** makes it reliable for all transmitted light observations.

For a more complete solution, choose among the several accessories available (objectives, translating stage, side extensions, holders and stage inserts).

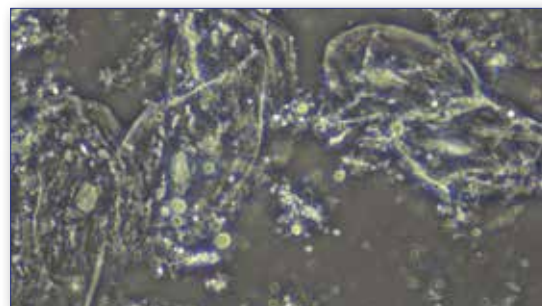

Part	Description
<b>Observation mode:</b>	Brightfield, phase contrast.
<b>Head:</b>	Trinocular (2-position 100/0, 50/50), 45° inclined.
<b>Interpupillary distance:</b>	Adjustable between 50 and 75 mm.
<b>Dioptric adjustment:</b>	On the left eyepiece tube.
<b>Eyepieces:</b>	WF10x/22 mm, high eye-point and with rubber cups.
<b>Nosepiece:</b>	Quintuple revolving nosepiece, rotation on ball bearings.
<b>Objectives:</b>	IOS LWD W-PLAN PH 10x/0.25 IOS LWD W-PLAN PH 20x/0.40 IOS LWD W-PLAN PH 40x/0.65 All with anti-fungus treatment.

Part	Description
<b>Specimen stage:</b>	Fixed stage, 250x160 mm, with glass and metal stage inserts.
<b>Focusing:</b>	Coaxial coarse (adjustable tension) and fine focusing mechanism with limit stop to prevent the contact between objective and specimen.
<b>Condenser:</b>	LWD pre-centered condenser, N.A. 0.30, W.D. 72 mm. With 4x/10x, 20x/40x phase contrast slider and brightfield. Removable to extend the working distance up to 150 mm.
<b>Transmitted illumination:</b>	X-LED <sup>®</sup> with white 8 W LED (6,300K) with brightness control. With aperture diaphragm. Multi-plug 100-240Vac/6Vdc external power supply.

# IM-3F - HBO Fluorescence Microscope

Routine inverted fluorescence microscope for transmitted brightfield, phase contrast and fluorescence observations with IOS LWD W-PLAN objectives. The HBO fluorescence illuminator is combined with blue and green excitation filter set for the visualization of the following fluorochromes: Acridine Yellow, Acridine Orange, Auramine, DiO, DTAF, FITC, GFP, YFP, etc. (blue) plus Rhodamine, Texas Red and TRITC (green). Transmitted light through the exclusive **X-LED<sup>®</sup>** to ensure great-looking, rich and high-quality specimen view.

-  22
- 
- 
- 
- 
- 
- 
- 
- 

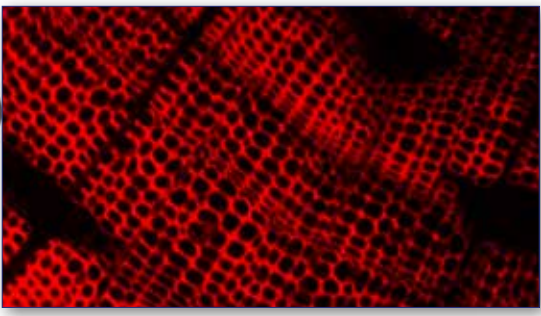
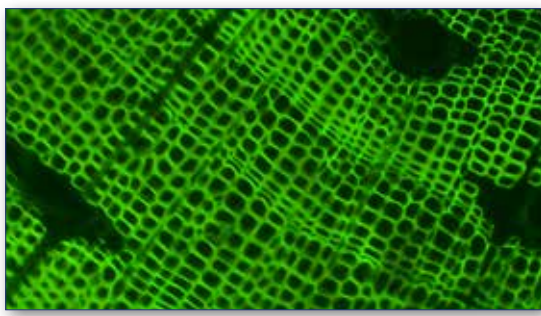

### Standard filtersets

Name	Excitation filter (nm)	Dichroic mirror cut-off (nm)	Emission filter (nm)
B (Blue)	450 – 490	495	520LP
G (Green)	527 – 553	565	575LP



Part	Description
<b>Observation mode:</b>	Brightfield, phase contrast, HBO fluorescence.
<b>Epi-illumination and filter:</b>	HBO 100 W high pressure mercury lamp. 3-position filter holder; blue & green included.
<b>Head:</b>	Trinocular (2-position 100/0, 0/100), 45° inclined.
<b>Interpupillary distance:</b>	Adjustable between 50 and 75 mm.
<b>Dioptric adjustment:</b>	On the left eyepiece tube.
<b>Eyepieces:</b>	WF10x/22 mm, high eye-point and with rubber cups.
<b>Nosepiece:</b>	Quintuple revolving nosepiece, rotation on ball bearings.
<b>Objectives:</b>	IOS LWD W-PLAN 4x/0.13 IOS LWD W-PLAN PH 10x/0.25 IOS LWD W-PLAN PH 20x/0.40 IOS LWD W-PLAN 40X/0.60 All with anti-fungus treatment.

Part	Description
<b>Specimen stage:</b>	Fixed stage, 250x160 mm, with glass and metal stage inserts.
<b>Focusing:</b>	Coaxial coarse (adjustable tension) and fine focusing mechanism with limit stop to prevent the contact between objective and specimen.
<b>Condenser:</b>	LWD pre-centered condenser, N.A. 0.30, W.D. 72 mm. With 4x/10x, 20x/40x phase contrast slider and brightfield. Removable to extend the working distance up to 150 mm.
<b>Transmitted illumination:</b>	X-LED <sup>®</sup> with white 8 W LED (6,300K) with brightness control. With aperture diaphragm. Multi-plug 100-240Vac/6Vdc external power supply.

# 2 IM-3FL4 - HBO Fluorescence Microscope

Advanced inverted microscope for brightfield and fluorescence observations with Semi-Apo IOS LWD U-PLAN F objectives to enhance the visibility of the sample and increase the overall contrast. The HBO fluorescence illuminator provides an outstanding flexibility of use, standing the blue and green filter sets (supplied as standard) for Auramine, FITC, GFP and YFP (with blue filter set) plus Rhodamine, Texas Red and TRITC (with the green one), yet giving the possibility to combine any other specific filter sets for future upgrade. Transmitted light through the exclusive **X-LED<sup>8</sup>** to ensure great-looking, rich and high-quality specimen view.

-  22
- 
- 
- 
- 
- 
- 
- 

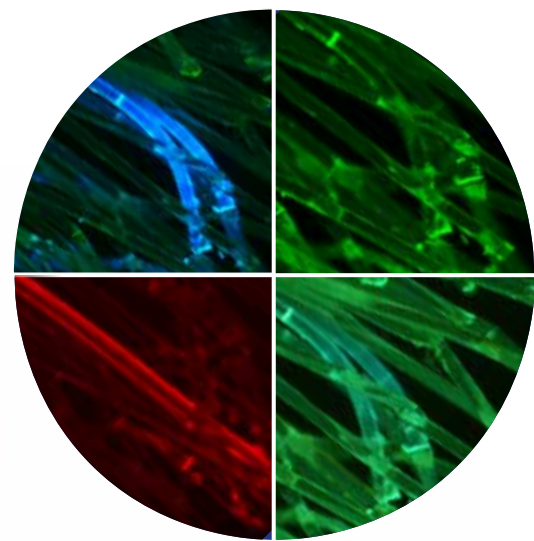

### Standard filterset

Name	Excitation filter (nm)	Dichroic mirror cut-off (nm)	Emission filter (nm)
B Blue	460 - 490	500	520LP
G Green	527 - 553	565	575LP

### Additional filterset (optional)

Name	Excitation filter (nm)	Dichroic mirror cut-off (nm)	Emission filter (nm)
V (Violet)	390 - 420	440	455LP
UV	325 - 375	415	435LP

Part	Description
<b>Observation mode:</b>	Brightfield, HBO fluorescence.
<b>Epi-illumination and filter:</b>	HBO 100 W high pressure mercury lamp. 4-position filter holder; blue & green included.
<b>Head:</b>	Trinocular (2-position 100/0, 0/100), 45° inclined.
<b>Interpupillary distance:</b>	Adjustable between 50 and 75 mm.
<b>Dioptric adjustment:</b>	On the left eyepiece tube.
<b>Eyepieces:</b>	WF10x/22 mm, high eye-point and with rubber cups.
<b>Nosepiece:</b>	Quintuple revolving nosepiece, rotation on ball bearings.
<b>Objectives:</b>	IOS LWD U-PLAN F 10x/0.30 IOS LWD U-PLAN F 20x/0.45 IOS LWD U-PLAN F 40x/0.65 All with anti-fungus treatment.

Part	Description
<b>Specimen stage:</b>	Fixed stage, 250x160 mm, with glass and metal stage inserts.
<b>Focusing:</b>	Coaxial coarse (adjustable tension) and fine focusing mechanism with limit stop to prevent the contact between objective and specimen.
<b>Condenser:</b>	LWD pre-centered condenser, N.A. 0.30, W.D. 72 mm. Removable to extend the working distance up to 150 mm.
<b>Transmitted illumination:</b>	X-LED <sup>8</sup> with white 8 W LED (6,300K) with brightness control. With aperture diaphragm. Multi-plug 100-240Vac/6Vdc external power supply.

# IM-3LD - LED Fluorescence Microscope

2

Routine inverted fluorescence microscope for transmitted brightfield, phase contrast and fluorescence observations with IOS LWD W-PLAN PH objectives. The LED fluorescence illuminator is combined with blue and green excitation filter set for the visualization of the following fluorochromes: Acridine Yellow, Acridine Orange, Auramine, DiO, DTAF, FITC, GFP, YFP, etc. (blue) plus Rhodamine, Texas Red and TRITC (green). LED fluorescence ensures unparalleled convenience eliminating warm-up/cool-down times and all the inconveniences related lamp replacement and adjustment. Transmitted light through the exclusive **X-LED<sup>®</sup>** to ensure great-looking, rich and high-quality specimen view.

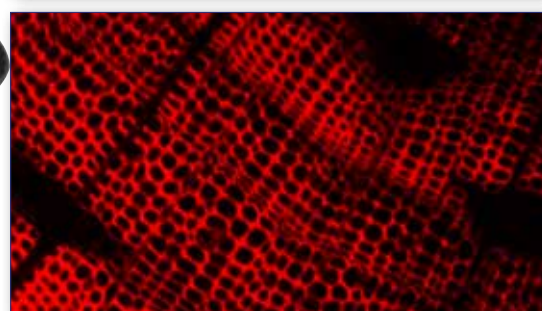
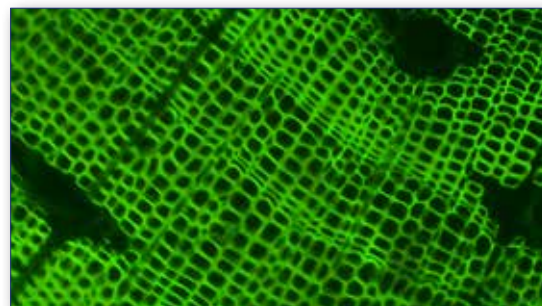

Laboratory

## Standard filterset

Name	Excitation filter (nm)	Dichroic mirror cut-off (nm)	Emission filter (nm)
B Blue	450 - 490	495	520LP
G Green	540 - 580	585	590LP

Part	Description
<b>Observation mode:</b>	Brightfield, phase contrast, LED fluorescence.
<b>Epi-illumination and filter:</b>	High-power 18 W LED with brightness control. 3-position filter holder; blue and green.
<b>Head:</b>	Trinocular (2-position 100/0, 0/100), 45° inclined.
<b>Interpupillary distance:</b>	Adjustable between 50 and 75 mm.
<b>Dioptric adjustment:</b>	On the left eyepiece tube.
<b>Eyepieces:</b>	WF10x/22 mm, high eye-point and with rubber cups.
<b>Nosepiece:</b>	Quintuple revolving nosepiece, rotation on ball bearings.
<b>Objectives:</b>	IOS LWD W-PLAN PH 10x/0.25 IOS LWD W-PLAN PH 20x/0.40 IOS LWD W-PLAN PH 40x/0.65 All with anti-fungus treatment.

Part	Description
<b>Specimen stage:</b>	Fixed stage, 250x160 mm, with glass and metal stage inserts.
<b>Focusing:</b>	Coaxial coarse (adjustable tension) and fine focusing mechanism with limit stop to prevent the contact between objective and specimen.
<b>Condenser:</b>	LWD pre-centered condenser, N.A. 0.30, W.D. 72 mm. With 4x/10x, 20x/40x phase contrast slider and brightfield. Removable to extend the working distance up to 150 mm.
<b>Transmitted illumination:</b>	X-LED <sup>®</sup> with white 8 W LED (6,300K) with brightness control. With aperture diaphragm. 100-240Vac/24Vdc external power supply.

# IM-3MET- Metallurgical Microscope

Routine inverted microscope with IOS LWD U-PLAN MET objectives for material science and metallographic applications, combining a sturdy yet compact structure with dedicated components required in this field, like the NCG (no cover glass) objectives working without cover slide ideal for metallographic samples and other opaque specimens. A particularly simple and ingenious optical design allows stable alignments and smooth and accurate movements.

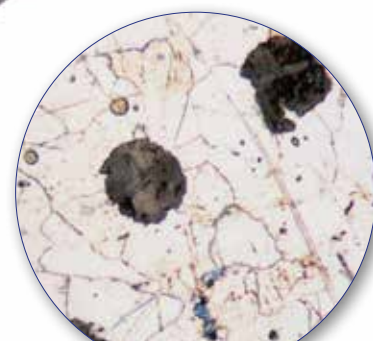

CAST IRON  
BRIGHTFIELD

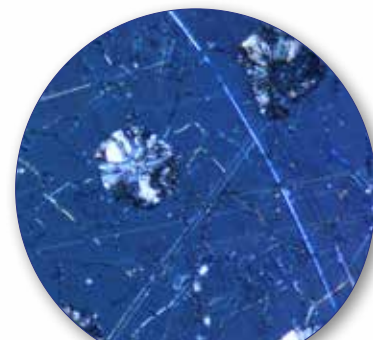

CAST IRON  
POLARIZED LIGHT

Part	Description
<b>Observation mode:</b>	Brightfield, simple polarized light on incident light.
<b>Epi-illumination and polarizing filters:</b>	Halogen 12 V/50 W with brightness control. With aperture and field (centrable) diaphragms. With polarizer and analyzer.
<b>Head:</b>	Trinocular (2-position 100/0, 50/50), 45° inclined.
<b>Interpupillary distance:</b>	Adjustable between 50 and 75 mm.
<b>Dioptric adjustment:</b>	On the left eyepiece tube.
<b>Eyepieces:</b>	WF10x/22 mm, high eye-point and with rubber cups.
<b>Nosepiece:</b>	Quintuple revolving nosepiece, rotation on ball bearings.

Part	Description
<b>Objectives:</b>	IOS LWD U-PLAN MET 5x/0.15 IOS LWD U-PLAN MET 10x/0.30 IOS LWD U-PLAN MET 20x/0.45 IOS LWD U-PLAN MET 50x/0.55 All with anti-fungus treatment.
<b>Specimen stage:</b>	Fixed stage, 250x160 mm, with metal stage insert.
<b>Focusing:</b>	Coaxial coarse (adjustable tension) and fine focusing mechanism with limit stop to prevent the contact between objective and specimen.



# IM-3 Series - Comparison chart

## Common features:

- **Head:** Trinocular (2-position), 45° inclined.
- **Eyepieces:** WF10x/22mm, high eye-point.
- **Nosepiece:** Quintuple, reversed, on ball bearings.
- **Stage:** Fixed, 250x160 mm (mechanical stage and side extension available as accessories).
- **Focusing mechanism:** Coaxial coarse (adjustable tension) and fine focusing mechanism with limit stop to prevent the contact between objective and specimen.

Model	Type	Objectives	Condenser	Incident illumination	Fluorescence slider	Transmitted illumination
<b>IM-3</b>	BF, PH	IOS LWD W-PLAN PH 10x, 20x, 40x	LWD, N.A. 0.30, iris diaphragm	-	-	8 W X-LED <sup>®</sup> , brightness control
<b>IM-3F</b>	BF, FL, PH	IOS LWD W-PLAN 4x, 10xPH, 20PH, 40x	LWD, N.A. 0.30, iris diaphragm	FL HBO with blue and green filtersets	2-position +BF	8 W X-LED <sup>®</sup> , brightness control
<b>IM-3FL4</b>	BF, FL	IOS LWD U-PLAN F 10x, 20x, 40x	LWD, N.A. 0.30, iris diaphragm	FL HBO with blue and green filtersets	3-position +BF	8 W X-LED <sup>®</sup> , brightness control
<b>IM-3LD</b>	BF, FL, PH	IOS LWD W-PLAN PH 10x, 20x, 40x	LWD, N.A. 0.30, iris diaphragm	FL LED with blue and green filtersets	2-position +BF	8 W X-LED <sup>®</sup> , brightness control
<b>IM-3MET</b>	MET	IOS LWD U-PLAN MET 5x, 10x, 20x, 50x	-	Halogen bulb, 12 V/50 W, brightness control	-	-

## IM-3 Series - Optical performance

### IM-3 / IM-3LD / IM-3F

Eyepiece	10x (M-780)			
Field number (mm)	22			
Objective	N.A.	W.D. (mm)	Total magnification	Field of view (mm)
4x	0.13	10.40	40x	5.50
10x PH	0.25	7.30	100x	2.20
20x PH	0.40	6.80	200x	1.10
40x PH	0.60	3.00	400x	0.55
60x	0.70	1.70	600x	0.37

### IM-3FL4

Eyepiece	10x (M-780)			
Field number (mm)	22			
Objective	N.A.	W.D. (mm)	Total magnification	Field of view (mm)
4x	0.13	18.52	40x	5.50
10x	0.30	7.11	100x	2.20
20x	0.45	5.91	200x	1.10
40x	0.65	1.61	400x	0.55
60x	0.75	1.04	600x	0.37

### IM-3MET

Eyepiece	10x (M-780)				15x (M-601)	
Field number (mm)	22				16	
Objective	N.A.	W.D. (mm)	Total magnification	Field of view (mm)	Total magnification	Field of view (mm)
5x	0.15	10.80	50x	4.40	75x	3.20
10x	0.30	10	100x	2.20	150x	1.60
20x	0.45	4	200x	1.10	300x	0.80
50x	0.55	7.90	500x	0.44	750x	0.32
100x	0.80	2.10	1000x	0.22	1500x	0.16

## Eyecups & Eyepieces

- M-601 WF15x/16 eyepiece, high eyepoint  
 M-780 PL10x/22 eyepiece, high eyepoint, with rubber cup  
 M-781 PL10x/22 micrometric eyepiece, high eyepoint, with rubber cup

## Objectives & Additional Lenses

### IOS W-PLAN

- M-1049 IOS W-PLAN objective 2x/0.08  
 M-782 IOS LWD W-PLAN objective 4x/0.10  
 M-773 IOS LWD W-PLAN objective 40x/0.60  
 M-786 IOS LWD W-PLAN objective 60x/0.70

### IOS W-PLAN PH

- M-782.1 IOS LWD W-PLAN PH objective 4x/0.13  
 M-783N IOS LWD W-PLAN PH objective 10x/0.25  
 M-784N IOS LWD W-PLAN PH objective 20x/0.40  
 M-785 IOS LWD W-PLAN PH objective 40x/0.65

### IOS U-PLAN F

- M-800 IOS LWD U-PLAN F objective 4x/0.13  
 M-801 IOS LWD U-PLAN F objective 10x/0.30  
 M-802 IOS LWD U-PLAN F objective 20x/0.45  
 M-803 IOS LWD U-PLAN F objective 40x/0.65  
 M-804 IOS LWD U-PLAN F objective 60x/0.75

### IOS U-PLAN F PH

- M-1177 IOS LWD U-PLAN F PH objective 20x/0.45  
 M-1178 IOS LWD U-PLAN F PH objective 40x/0.65

### IOS U-PLAN MET

- M-1100 IOS LWD U-PLAN MET objective 5x/0.15  
 M-1101 IOS LWD U-PLAN MET objective 10x/0.30  
 M-1102 IOS LWD U-PLAN MET objective 20x/0.45  
 M-1103 IOS LWD U-PLAN MET objective 50x/0.55  
 M-1104 IOS LWD U-PLAN MET objective 100x/0.80 (dry)

## Attachments

- M-797-EU HBO fluo attachment, 2-pos. (B & G filter set), EU (only for IM-3)  
 M-797-UK HBO fluo attachment, 2-pos. (B & G filter set), UK (only for IM-3)  
 M-797-US HBO fluo attachment, 2-pos. (B & G filter set), US (only for IM-3)  
 M-797-SW HBO fluo attachment, 2-pos. (B & G filter set), CH (only for IM-3)  
 M-798-EU HBO fluo attachment, 4-pos. (B & G filter set), EU (only for IM-3)  
 M-798-UK HBO fluo attachment, 4-pos. (B & G filter set), UK (only for IM-3)  
 M-798-US HBO fluo attachment, 4-pos. (B & G filter set), US (only for IM-3)  
 M-798-SW HBO fluo attachment, 4-pos. (B & G filter set), CH (only for IM-3)

## Stages

- M-792 Mechanical stage

## Condensers & Filters

- M-676 Empty fluorescence filterblock (only for IM-3F)  
 M-677 Fluorescence filter set V (filterblock included) (only for IM-3F)  
 M-677.1 Fluorescence filter set V (filterblock NOT included) (only for IM-3F & IM-3FL4)  
 M-677ND Neutral density filter, 25% transmission (only for IM-3F & IM-FL4)  
 M-678 Fluorescence filter set UV-DAPI (filterblock included) (only for IM-3F)  
 M-678.1 Fluorescence filter set UV-DAPI (filterblock NOT included) (only for IM-3F & IM-3FL4)  
 M-678ND Neutral density filter, 50% transmission (only for IM-3F & IM-3FL4)



### How to connect the cameras to our microscopes.

Please refer to the Adapter reference list on Digital section.

## Camera Adapters

- M-113.1 Ring adapter, 30mm (for monocular and binocular microscopes)  
 M-115 0.35x C-Mount projection lens  
 M-114 0.5x C-Mount projection lens  
 M-118 0.75x C-Mount projection lens  
 M-173 C-Mount projection lens for APS-C/full frame reflex cameras (trino)  
 M-620 0.35x focusable C-Mount adapter (biological microscopes)  
 M-620.1 0.5x focusable C-Mount adapter (biological microscopes)  
 M-620.2 0.65x focusable C-Mount adapter (biological microscopes)  
 M-620.3 1x focusable C-Mount adapter (biological & stereomicroscopes)  
 M-699 Universal adapter for C-Mount projection lens (trino)

## Miscellaneous

- 15104 Cleaning kit  
 DC-004 TNT dust cover, large, 700(l)x550(h) mm  
 M-005 Micrometric slide, 26x76mm, with 2 scales (1mm/100 & 10mm/100)  
 M-151 HBO 100W high-pressure mercury bulb for fluorescence (only for IM-3F & IM-3FL4)  
 M-151.1 HBO 100W high-pressure mercury bulb for fluorescence (OSRAM) (only for IM-3F & IM-3FL4)  
 M-622 Halogen bulb 12V/50W (only for IM-3MET)  
 M-785.2N Slider with phase rings (4x/10x, 20x/40x, BF) (except for IM-3MET)  
 M-793.1 Holder for Petri 38mm diameter (M-793.2 needed) (except for IM-3MET)  
 M-793.2 Holder for Terasaki and Petri 65mm diameter (except for IM-3MET)  
 M-793.3 Holder for slides and Petri 54mm diameter (except for IM-3MET)  
 M-793.4 Holder for 2+2 slides (except for IM-3MET)  
 M-793.5 Holder for metallurgical samples (only for IM-3MET)  
 M-793.6 Holder for Utermohl-Chamber (M-793.3 needed) (except for IM-3MET)  
 M-793.7 Load bearing side extension  
 M-1004.N Centering telescope, 30mm diameter  
 VP-IM3 IQ/OQ/PQ manual for IM-3 series

### 15104 - Cleaning kit

It cleans glass quickly and effectively, without leaving residue or odor. Ideal for precision lens or prism cleaning.



## Headquarters and Manufacturing Facilities

**OPTIKA® S.r.l.** Via Rigla, 30 - 24010 Ponteranica (BG) - ITALY - Tel.: +39 035.571.392 - info@optikamicroscopes.com

## Optika Sales branches

**OPTIKA® Spain** spain@optikamicroscopes.com  
**OPTIKA® China** china@optikamicroscopes.com  
**OPTIKA® India** india@optikamicroscopes.com

**OPTIKA® USA** usa@optikamicroscopes.com  
**OPTIKA® Central America** camerica@optikamicroscopes.com

## IM-5 Series



**Routine & Research Lab Inverted Microscopes**

# The Best Option for Routine & Research

## INTUITIVE YET SUPERIOR CONFIGURATIONS FOR PROFESSIONALS

- » Wide range to fulfill specific lab requirements
- » Valuable solutions for life and material sciences
- » Compliant with several observation methods

## AN AFFORDABLE PARTNER WITH UNIQUE HIGH-END FEATURES

- » IOS LWD U-PLAN objectives for flat images on 24 mm FN
- » Fast, efficient investigation with no particular sample prep
- » Trinocular port with beam splitter for most light-demanding needs



## Optically Impressive

### MAINTAINING GOOD EYESIGHT

- » 10x/24 eyepieces for the highest F.O.V. on an inverted microscope
- » Comfortable rubber cup to get rid of annoying external light
- » High eye-point for glasses wearers and dioptic adjustment

### IM-5 & IOS U-PLAN: THE PERFECT COMBINATION

- » IOS Infinity corrected optical system
- » Full planarity optics on 24 mm (U-PLAN) according to ISO 19012-1
- » High-grade Semi-Apo lens available ideal for fluorescence



# An Extensive Range of Different Configurations

## OBSERVE EVEN THE MOST COMPLEX SAMPLES

- » Phase contrast lens for transparent sample examination
- » Motorized LED fluorescence available for specific purposes
- » High quality no cover glass objectives for material science

## AUTOMATIC LED SELECTION & CONCEPTUAL INNOVATION IN LED FLUORESCENCE

- » Choose the fluorescence filter for motorized LED selection
- » Immediate operation, eliminating warm-up/cool-down times
- » Forget about lamp centering, adjustment and maintenance

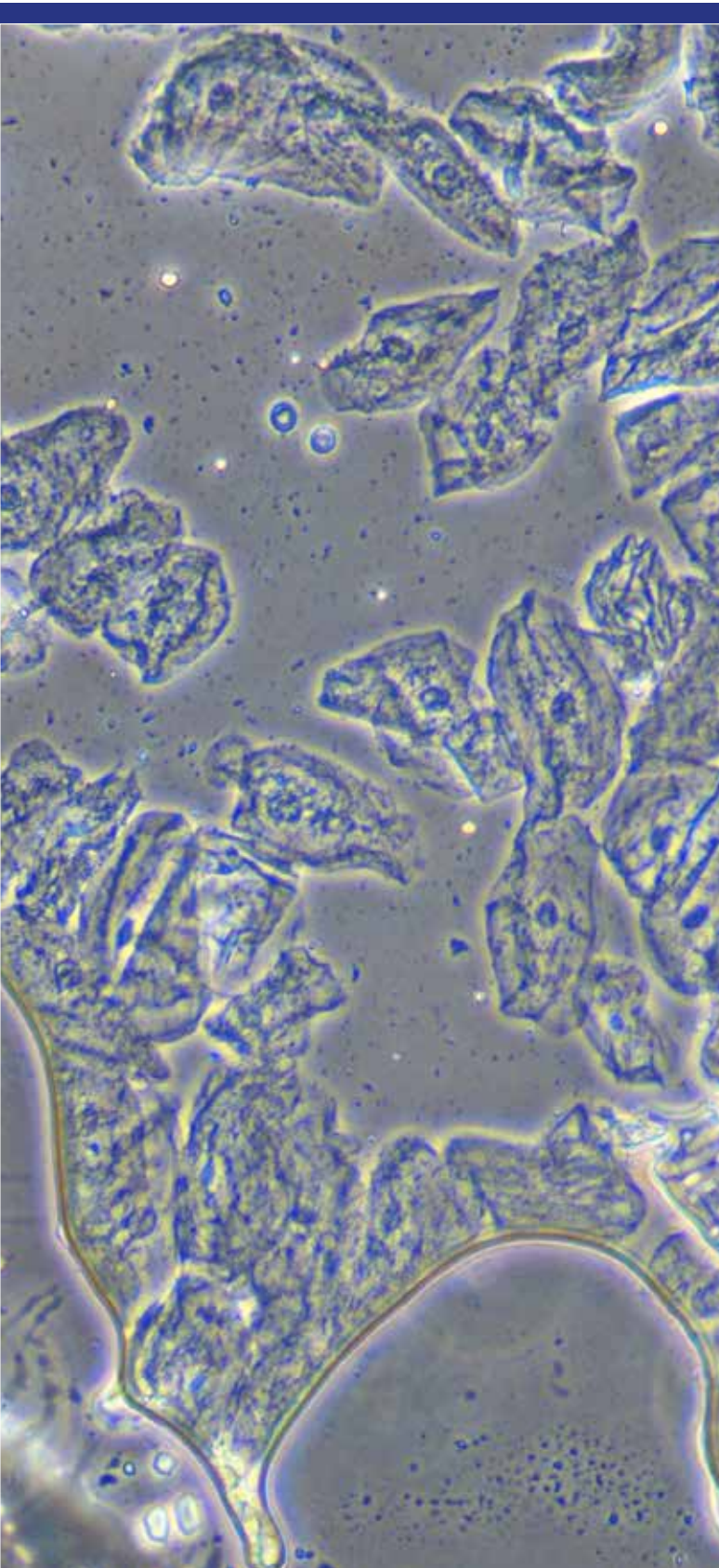

# Born To Be Professional

## DESIGNED TO FACILITATE YOUR DAILY ACTIVITIES

- » Mechanical stage and side extensions for great comfort
- » Large, resistant stage to easily and quickly process samples
- » Different inserts available according to the container used

## CREATE YOUR COMPLETE, FLEXIBLE WORKING STATION

- » Integrable micromanipulation system available
- » Hoffman® modulation contrast available
- » Stage top incubation system available



# Go Digital - Vivid Colors & Contrast For Stunning Images

2

## STAY CONNECTED WITH YOUR SPECIMEN, EASILY

- » Trinocular port to be always updated with the latest technology cameras, even in the future
- » Wide range of cameras matching all the needs, including the more specific ones
- » Modern C-mount focusable professional adapters for all kinds of cameras

## PROFESSIONAL IMAGE ANALYSIS

- » Multi-language software for live-view, picture and video in different file formats
- » Advanced functions for pictures processing (EDF, stitching, multi-fluorescence combine)
- » Powerful tools to perform measurements and generate custom reports

Laboratory

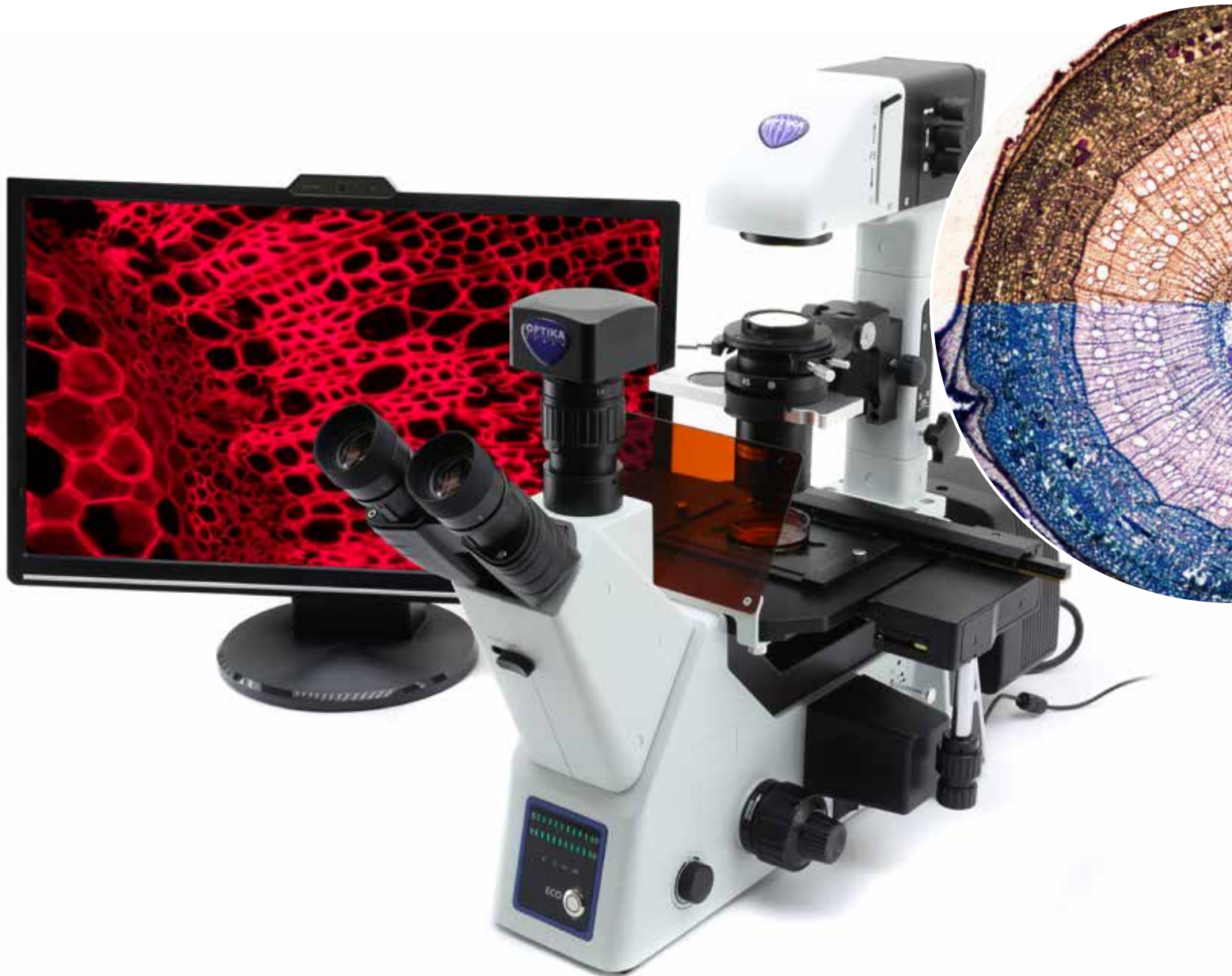

# X-LED<sup>8</sup> - Only Available at OPTIKA

## STATE-OF-THE-ART ILLUMINATION SYSTEM

- » Uncomparable light intensity, exclusive lens & collector design
- » Constant pure-white color temperature at all intensity levels
- » Unmatched color fidelity, uniformity and brightness

## CUT ELECTRICITY BILLS BY 90%

- » Money & energy saving, 8 W (on X-LED<sup>8</sup>)
- » More efficient brightness than a 100 W (for X-LED<sup>8</sup>) halogen lamp
- » LED long lifetime (65,000 hours = 22 years at 8 hours/day usage)

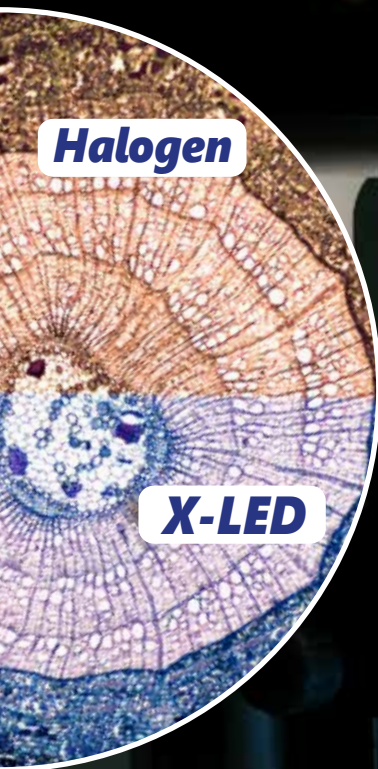

Halogen

X-LED





# Adjust It To Your Individual Needs

## FULLY SETTABLE, ADJUSTABLE IN HEIGHT CONDENSER FOR PERFECT IMAGING

- » Full Koehler illumination for enhanced images
- » Field & aperture diaphragms, centrable; N.A. 0.50 condenser
- » Removable/rotatable condenser to increase the working distance

## IMPROVED OPTICAL PERFORMANCE, LONG WORKING DISTANCE

- » Superior image quality, crisp and bright details
- » Excellent contrast and resolution due to high numerical apertures
- » Comprehensive range of objectives for extended versatility



## IM-5 Series

### **BRIGHTFIELD**

Transmitted brightfield illumination is one of the most commonly used observation method in optical microscopy, and is ideal for fixed, stained specimens or other types of samples having high natural absorption of visible light.

IM-3 Series is fitted with high-efficiency LED brightfield illuminator, for the best outcome when using this technique.

Capsella middle embryo - IM-3 - Brightfield

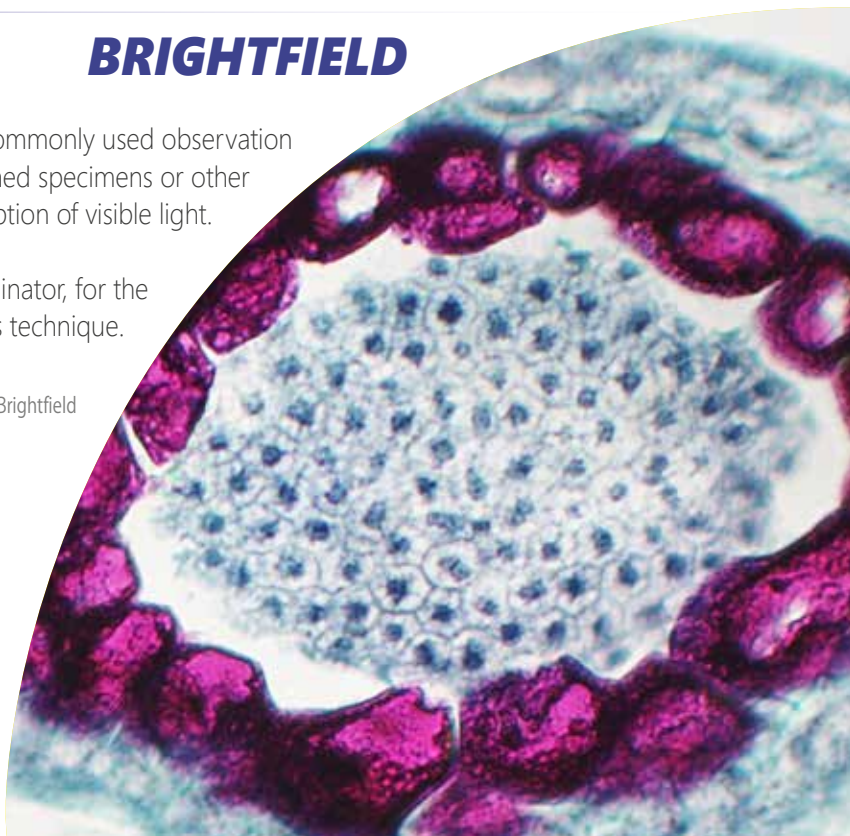

### **FLUORESCENCE**

The fluorescence microscopy is the most demanding technique in biology and biomedical sciences, as well as in materials science.

This method is capable to study organic and inorganic samples thanks to primary fluorescence (auto-fluorescence) or secondary (staining and labelling with fluorochromes)

IM-Series is tailored for applications in research, clinical and pharmaceutical diagnostic field.

Fluorescence illuminators available as mercury lamp (IM-3F & IM-3FL4) and also as LED (IM-3LD).

Cotton fibers - IM-3FL4 - UV Fluorescence



# Multiple Observation Methods

## **MATERIAL SCIENCE / METALLOGRAPHY**

Reflected light microscopy is the method for observation of specimens that remain opaque even when ground to a thickness of few microns. The range of specimens falling into this category is incredibly wide and includes most metals, ores, ceramics, many polymers, semiconductors (unprocessed silicon, wafers, and integrated circuits), coal, plastics, paint, paper, wood, leather, glass inclusions, and a wide variety of specific materials.

Brass (not polished) - IM-3MET - Material Science

## **PHASE CONTRAST**

Phase-contrast microscopy is a particular technique applied in transparent, non-stainable, samples like culture of living cells, microorganisms, lithographic patterns, latex dispersions, fibers, asbestos and subcellular particles.

It reveals many cellular structures that are not visible with a simple brightfield microscope.

Diatoms - IM-3 - Phase contrast

## IM-5 Series

### Significant Time And Money Saving

The IM-5 Series has been designed to increase comfort and achieve significant benefits, especially in terms of time saving with quick and intuitive installation, pre-aligned phase contrast system and pre-aligned LED light source.

As time is money, these features bring to a drastic impact on cost reduction, even more evident thanks to the exclusive illumination system provided by OPTIKA.

### X-LED<sup>®</sup> Exclusive Lighting Source

Special technology able to double the light intensity for incomparable performance, ensuring constant pure-white colour temperature (6,300K colour temperature).

Relevant money and energy saving thanks to the incredibly low energy consumptions which allows you to cut the electricity bills by 90%!

The electric consumption (8 W) proves the high efficiency of this system: incredibly high light intensity combined with low consumption.

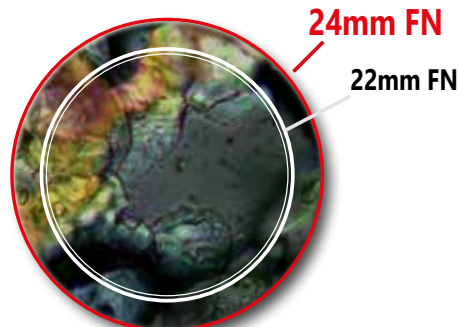

### The Widest Specimen Area Available (24mm Field Number)

The **F.O.V.** (field of view) is based on a very comfortable diameter of 24 mm.

This means that an extra wide area of the sample can be inspected and allows a natural and easy view, particularly needed in a laboratory environment.

### Panel With LED Illumination Indicator And ECO Function

IM-5 ensures significant repeatability since the level of light intensity can be seen at any time from the frontal panel in order to reproduce the same conditions. "ECO" button makes the microscope more environmentally sensitive, with automatic switch-off after 20 minutes of inactivity.



# Routine & Research Lab Inverted Microscopes

## In fluorescence we offer the latest technology.

IM-5FLD is a state-of-the art LED fluorescence microscope, equipped with motorized selection of the best LED according to the filter selected (blue, green, UV and an empty position fo optional filter) by using the filter holder slide.

### Innovative, LED Fluorescence

- » Cost-effective, money saving technology
- » Ready for immediate operation
- » Eliminate warm-up/cool-down times
- » Forget lamp replacement & centering



## Get the most out of our accessories



**M-793.4**  
Holder for 2+2 slides.  
(Only for IM-5 and IM-5FLD)



**M-793.5**  
Holder for small metallurgical samples.  
(Only for IM-5MET)



**M-793.6**  
Holder for Utermöhl-Chamber.  
(Only for IM-5 and IM-5FLD)

## Accessories included



Holder for Petri diameter 38mm.  
(Included with IM-5 and IM-5FLD)



Holder for Terasaki and Petri  
diameter 65mm.  
(Included with IM-5 and IM-5FLD)



Holder for slide and Petri  
diameter 54mm.  
(Included with IM-5 and IM-5FLD)

# IM-5 - Brightfield & Phase Contrast Microscope

Phase contrast, brightfield and darkfield (dry) trinocular inverted microscope ideal for laboratory requirements (especially cell culture), with freely configurable lenses according to customer's preferences, FN 24 high eyepoint, infinity corrected optical system, coaxial focusing, mechanical stage, Abbe condenser and powerful, uniform, white color temperature 8 W **X-LED<sup>®</sup>**. Sturdy and incredibly reliable, it is equipped with all the main controls in ergonomic position and with long lasting LED illumination to provide over 20 years of use.



# IM-5 - Specifications



Part	Description
<b>Head:</b>	Trinocular (split ratio: 100/0, 50/50), 45° inclined.
<b>Dioptric adjustment:</b>	Both eyepieces.
<b>Eyepieces:</b>	WF10x/24 mm, high eyepoint and with retractable rubber cups.
<b>Nosepiece:</b>	Quintuple ball bearings revolving nosepiece, reversed.
<b>Objectives:</b>	Selectable according to customer's preferences. All with anti-fungus treatment.
<b>Specimen stage:</b>	Fixed stage, 215x250 mm and attachable mechanical stage, 290x250 mm, 120x80 mm X-Y movement range.
<b>Focusing:</b>	Coaxial coarse and fine focusing mechanism with limit stop to prevent the contact between objective and specimen. Adjustable tension of coarse focusing knob.
<b>Condenser:</b>	Abbe N.A. 0.50, removable, with iris diaphragm and slider for phase contrast.
<b>Transmitted illumination (Full Koehler):</b>	X-LED <sup>®</sup> with white 8 W LED and brightness control. Color temperature: 6,300 K. Multi-plug 100-240Vac/12Vdc external power supply.

## IM-5 is freely configurable in terms of objectives, by choosing among:

Included ■ Optional □

Infinity-corrected Plan-Achromatic, Long Working Distance objectives, field flatness up to F.N. 22:

M-782	IOS LWD W-PLAN objective 4x/0.13	□
M-773	IOS LWD W-PLAN objective 40x/0.60	□
M-786	IOS LWD W-PLAN objective 60x/0.70	□

Positive Phase Contrast Infinity-corrected Plan-Achromatic, Long Working Distance objectives, field flatness up to F.N. 22:

M-782.1	IOS LWD W-PLAN PH objective 4x/0.13	□
M-783N	IOS LWD W-PLAN PH objective 10x/0.25	□
M-784N	IOS LWD W-PLAN PH objective 20x/0.40	□
M-785	IOS LWD W-PLAN PH objective 40x/0.65	□

Infinity-corrected Semi-Apochromatic, Long Working Distance objectives, field flatness up to F.N. 25:

M-800	IOS LWD U-PLAN F objective 4x/0.13	□
M-801	IOS LWD U-PLAN F objective 10x/0.30	□
M-802	IOS LWD U-PLAN F objective 20x/0.45	□
M-803	IOS LWD U-PLAN F objective 40x/0.65	□
M-804	IOS LWD U-PLAN F objective 60x/0.75	□

Positive Phase Contrast Infinity-corrected Semi-Apochromatic, Long Working Distance objectives, field flatness up to F.N. 25:

M-1177	IOS LWD U-PLAN F PH objective 20x/0.45	□
M-1178	IOS LWD U-PLAN F PH objective 40x/0.65	□

# IM-5FLD - LED Fluorescence Microscope

Phase contrast, brightfield and darkfield (dry) LED fluorescence trinocular inverted microscope, with freely configurable lenses according to customer's preferences, FN 24 high eyepoint, infinity corrected optical system, coaxial focusing, mechanical stage, Abbe condenser and powerful, uniform, white color temperature 8 W **X-LED8**. The 4-position epi-fluorescence attachment is powered by extremely powerful 5 W LEDs fluorescence illuminator and combined with blue, green and UV excitation filters for the visualization of the following fluorochromes: Acridine Yellow, Acridine Orange, Auramine, DiO, DTAF, FITC, GFP, YFP (blue filter) plus Rhodamine, Texas Red and TRITC (green filter) plus Alexa Fluor® 350, 7- Amino-4-methylcoumarin, 6-Aminoquinoline, Calcofluor® White, Dansyl cadaverine, DAPI, Dapoxyl, DIDS, Europium (III) Chloride, Fluoro-Gold™, Fura-2, Hoechst 33342 & 33258, 1,5 IAEDANS, Indo-1, Marina Blue®, 4-Methylumbelliferone, PBF1, Pyrene, SBF1, Y66F, Y66H (UV filter) among the others. LED fluorescence ensures unparalleled convenience eliminating warm-up/cool-down times and all the inconveniences related lamp replacement and adjustment. Sturdy and incredibly reliable, it is equipped with all the main controls in ergonomic position and with long lasting, efficient LED illumination to provide over 20 years of use.





# IM-5FLD - Specifications



Part	Description
<b>Head:</b>	Trinocular (split ratio: 100/0, 0/100), 45° inclined.
<b>Dioptric adjustment:</b>	Both eyepieces.
<b>Eyepieces:</b>	WF10x/24 mm, high eyepoint and with retractable rubber cups.
<b>Epi-fluorescence illumination &amp; filters:</b>	High-power 5 W LEDs with brightness control, motorized LED selection with centrable field diaphragm, 4-position filter holder; blue (EX 450-490, DM 495, EM 500-550), green (EX 540-580, DM 585, EM 608-682) and UV (EX 340-390, DM 400, EM 420LP) excitation filters included.
<b>Nosepiece:</b>	Quintuple ball bearings revolving nosepiece, reversed.
<b>Objectives:</b>	Selectable according to customer's preferences. All with anti-fungus treatment.
<b>Specimen stage:</b>	Fixed stage, 215x250 mm and attachable mechanical stage, 290x250 mm, 120x80 mm X-Y movement range.
<b>Focusing:</b>	Coaxial coarse and fine focusing mechanism with limit stop to prevent the contact between objective and specimen. Adjustable tension of coarse focusing knob.
<b>Condenser:</b>	Abbe N.A. 0.50, removable, with iris diaphragm and slider for phase contrast.
<b>Transmitted illumination (Full Koehler):</b>	X-LED <sup>®</sup> with white 8 W LED and brightness control. Color temperature: 6,300 K. Multi-plug 100-240Vac/12Vdc external power supply.

## Fluorescence filtersets

Name	Excitation filter (nm)	Dichroic mirror cut-off (nm)	Emission filter (nm)
<b>B (Blue)</b>	450 – 490	495	500 - 550
<b>G (Green)</b>	540 – 580	585	607 - 682
<b>UV (Ultraviolet)</b>	340 -390	400	420LP

### IM-5FLD is freely configurable in terms of objectives, by choosing among:

Included ■ Optional □

Infinity-corrected Plan-Achromatic, Long Working Distance objectives, field flatness up to F.N. 22:		
M-782	IOS LWD W-PLAN objective 4x/0.13	□
M-773	IOS LWD W-PLAN objective 40x/0.60	□
M-786	IOS LWD W-PLAN objective 60x/0.70	□

Infinity-corrected Semi-Apochromatic, Long Working Distance objectives, field flatness up to F.N. 25:		
M-800	IOS LWD U-PLAN F objective 4x/0.13	□
M-801	IOS LWD U-PLAN F objective 10x/0.30	□
M-802	IOS LWD U-PLAN F objective 20x/0.45	□
M-803	IOS LWD U-PLAN F objective 40x/0.65	□
M-804	IOS LWD U-PLAN F objective 60x/0.75	□

Positive Phase Contrast Infinity-corrected Plan-Achromatic, Long Working Distance objectives, field flatness up to F.N. 22:		
M-782.1	IOS LWD W-PLAN PH objective 4x/0.13	□
M-783N	IOS LWD W-PLAN PH objective 10x/0.25	□
M-784N	IOS LWD W-PLAN PH objective 20x/0.40	□
M-785	IOS LWD W-PLAN PH objective 40x/0.65	□

Positive Phase Contrast Infinity-corrected Semi-Apochromatic, Long Working Distance objectives, field flatness up to F.N. 25:		
M-1177	IOS LWD U-PLAN F PH objective 20x/0.45	□
M-1178	IOS LWD U-PLAN F PH objective 40x/0.65	□

# IM-5MET - Metallurgical Microscope

Industrial and materials science inverted microscope especially designed for opaque specimens (including metals microstructure investigation and studies such as grain size, grain boundaries, phases, transformation, inclusions, and non-metals, as well as sample preparation and treatment) in metallography labs. Freely configurable lenses according to customer's preferences, FN 24 high eyepoint, infinity corrected optical system, coaxial focusing, mechanical stage, and epi-illumination attachment powered by halogen 12 V/100 W with brightness control. Sturdy and incredibly reliable, it is equipped with all the main controls in ergonomic position and with long lasting, efficient LED illumination to provide over 20 years of use.

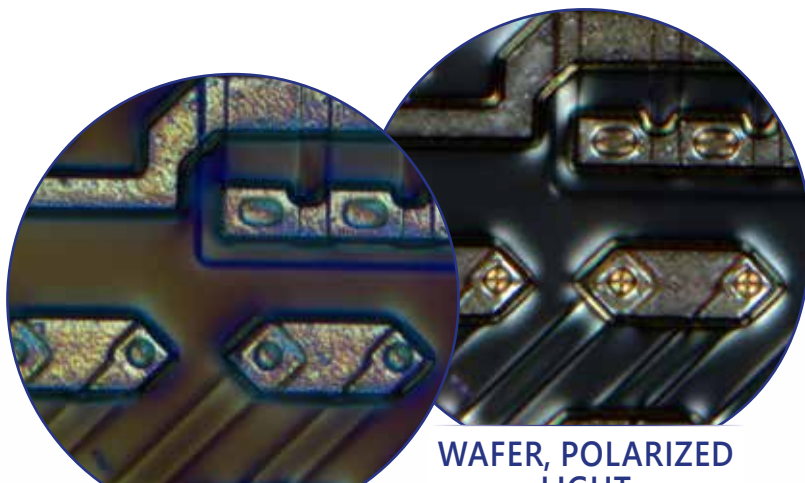

WAFER, DIC

WAFER, POLARIZED  
LIGHT



# IM-5MET - Specifications



Part	Description
<b>Head:</b>	Trinocular (split ratio: 100/0, 50/50), 45° inclined.
<b>Dioptric adjustment:</b>	Both eyepieces.
<b>Eyepieces:</b>	WF10x/24 mm, high eyepoint, secured by screw and with retractable rubber cups.
<b>Epi-illumination &amp; filters:</b>	Halogen 12 V/100 W with brightness control. With field and aperture diaphragms, polarizer and analyzer filters.
<b>Nosepiece:</b>	Quintuple ball bearings revolving nosepiece, reversed.
<b>Objectives:</b>	Selectable according to customer's preferences. All with anti-fungus treatment.
<b>Specimen stage:</b>	Mechanical stage, 240x250 mm.
<b>Focusing:</b>	Coaxial coarse and fine focusing mechanism with limit stop to prevent the contact between objective and specimen. Adjustable tension of coarse focusing knob.

## IM-5MET is freely configurable in terms of objectives, by choosing among:

Included ■ Optional □

MET Infinity-corrected Plan-Achromatic, Long Working Distance objectives, field flatness up to F.N. 25:		
M-1100	IOS LWD U-PLAN MET objective 5x/0.15	□
M-1101	IOS LWD U-PLAN MET objective 10x/0.30	□
M-1102	IOS LWD U-PLAN MET objective 20x/0.45	□
M-1103	IOS LWD U-PLAN MET objective 50x/0.55	□
M-1104	IOS LWD U-PLAN MET objective 100x/0.80 (dry)	□

MET Infinity-corrected Semi-Apochromatic, Long Working Distance objectives, field flatness up to F.N. 25:		
M-1171	IOS LWD U-PLAN F MET objective 5x/0.15	□
M-1172	IOS LWD U-PLAN F MET objective 10x/0.30	□
M-1173	IOS LWD U-PLAN F MET objective 20x/0.50	□
M-1174	IOS LWD U-PLAN F MET objective 50x/0.80	□
M-1175	IOS LWD U-PLAN F MET objective 100x/0.90 (dry)	□

MET Infinity-corrected Plan-Achromatic, Long Working Distance objectives, for brightfield and darkfield, field flatness up to F.N. 25:		
M-1094	IOS LWD U-PLAN MET BD objective 5x/0.15	□
M-1095	IOS LWD U-PLAN MET BD objective 10x/0.30	□
M-1096	IOS LWD U-PLAN MET BD objective 20x/0.45	□
M-1097	IOS LWD U-PLAN MET BD objective 50x/0.55	□
M-1098	IOS LWD U-PLAN MET BD objective 100x/0.80 (dry)	□

MET Infinity-corrected Semi-Apochromatic, Long Working Distance objectives, for brightfield and darkfield, field flatness up to F.N. 25:		
M-1180	IOS LWD U-PLAN F MET BD objective 5x/0.15	□
M-1181	IOS LWD U-PLAN F MET BD objective 10x/0.30	□
M-1182	IOS LWD U-PLAN F MET BD objective 20x/0.50	□
M-1183	IOS LWD U-PLAN F MET BD objective 50x/0.80	□
M-1184	IOS LWD U-PLAN F MET BD objective 100x/0.90 (dry)	□

## IM-5 Series - Comparison Chart

### Common features:

- **Head:** Trinocular (2-position 100/0, 0/100), 45° inclined.
- **Eyepieces:** PL10x/24 mm, with dioptic adjustment, high eye-point and rubber cups. Dioptic adjustment on both eyepieces.
- **Focusing mechanism:** Coaxial coarse (adjustable tension) and fine focusing mechanism with limit stop to prevent the contact between objective and specimen.

Model	Type	Nosepiece	Stage	Condenser	Incident illumination	Fluorescence slider	Transmitted illumination
<b>IM-5</b>	BF, PH	Quintuple revolving nosepiece, rotation on ball bearings	Fixed, 215x250 mm can be equipped with mechanical (included), 290x250 mm, 120x80 mm movement range	N.A. 0.50 Köhler, W.D. 28 mm, rotatable to extend the W.D.	-	-	8 W X-LED <sup>®</sup> , brightness control and ECO function
<b>IM-5FLD</b>	BF, FL, PH	Quintuple revolving nosepiece, rotation on ball bearings	Fixed, 215x250 mm can be equipped with mechanical (included), 290x250 mm, 120x80 mm movement range	N.A. 0.50 Köhler, W.D. 28 mm, rotatable to extend the W.D.	FL LED with Blue, Green and UV filtersets	4-position	8 W X-LED <sup>®</sup> , brightness control and ECO function
<b>IM-5MET</b>	BF MET, DF MET	Quintuple revolving nosepiece, rotation on ball bearings. With 26 mm thread holes, 5 adapter rings (for RMS objectives) and DIC slot	Rackless, mechanical, 240x250 mm, 50x50 mm movement range	-	Halogen bulb, 12 V/100 W, brightness control and ECO function	-	-



# IM-5 Series - Optical Performance

Infinity-corrected Plan-Achromatic, Long Working Distance objectives, field flatness up to F.N. 22:

Eyepiece		10x (M-880)		
Field number		24 (mm)		
Objective	N.A.	W.D. (mm)	Total magnification	Field of view (mm)
4x	0.13	10.40	40x	6.0
40x	0.60	3.10	400x	0.60
60x	0.70	1.70	600x	0.40

Infinity-corrected Semi-Apochromatic, Long Working Distance objectives, field flatness up to F.N. 25:

Eyepiece		10x (M-880)		
Field number		24 (mm)		
Objective	N.A.	W.D. (mm)	Total magnification	Field of view (mm)
4x	0.13	18.52	40x	6.0
10x	0.30	7.11	100x	2.4
20x	0.45	5.91	200x	1.2
40x	0.65	1.61	400x	0.60
60x	0.75	1.04	600x	0.40

Positive Phase Contrast Infinity-corrected Plan-Achromatic, Long Working Distance objectives, field flatness up to F.N. 22:

Eyepiece		10x (M-880)		
Field number		24 (mm)		
Objective	N.A.	W.D. (mm)	Total magnification	Field of view (mm)
4x	0.13	10.40	40x	6.0
10x	0.25	7.30	100x	2.4
20x	0.40	6.80	200x	1.2
40x	0.60	3.00	400x	0.60

Positive Phase Contrast Infinity-corrected Semi-Apochromatic, Long Working Distance objectives, field flatness up to F.N. 25:

Eyepiece		10x (M-880)		
Field number		24 (mm)		
Objective	N.A.	W.D. (mm)	Total magnification	Field of view (mm)
20x	0.45	5.91	20x	1.2
40x	0.65	1.61	400x	0.60

MET Infinity-corrected Plan-Achromatic, Long Working Distance objectives, field flatness up to F.N. 25:

Eyepiece		10x (M-880)		
Field number		24 (mm)		
Objective	N.A.	W.D. (mm)	Total magnification	Field of view (mm)
5x	0.15	10.80	50x	4.8
10x	0.30	10.00	100x	2.40
20x	0.45	4.00	200x	1.20
50x	0.55	7.90	500x	0.48
100x	0.80	2.10	1000x	0.24

MET Infinity-corrected Semi-Apochromatic, Long Working Distance objectives, field flatness up to F.N. 25:

Eyepiece		10x (M-880)		
Field number		24 (mm)		
Objective	N.A.	W.D. (mm)	Total magnification	Field of view (mm)
5x	0.15	19.50	50x	4.8
10x	0.30	10.9	100x	2.40
20x	0.50	3.20	200x	1.20
50x	0.80	1.2	500x	0.48
1000x	0.90	1.00	1000x	0.24

MET Infinity-corrected Plan-Achromatic, Long Working Distance objectives, for brightfield and darkfield, field flatness up to F.N. 25:

Eyepiece		10x (M-880)		
Field number		24 (mm)		
Objective	N.A.	W.D. (mm)	Total magnification	Field of view (mm)
5x	0.15	9.00	50x	4.8
10x	0.30	9.00	100x	2.40
20x	0.45	3.40	200x	1.20
50x	0.55	7.50	500x	0.48
100x	0.80	2.00	1000x	0.24

MET Infinity-corrected Semi-Apochromatic, Long Working Distance objectives, for brightfield and darkfield, field flatness up to F.N. 25:

Eyepiece		10x (M-880)		
Field number		24 (mm)		
Objective	N.A.	W.D. (mm)	Total magnification	Field of view (mm)
5x	0.15	13.50	50x	4.8
10x	0.30	9.00	100x	2.40
20x	0.50	2.50	200x	1.20
50x	0.80	1.00	500x	0.48
100x	0.90	1.00	1000x	0.24



# IM-5 Series - Accessories

## Eyecups & Eyepieces

- M-880 PL10x/24 eyepiece, high eyepoint, focusable, with rubber cup  
 M-881 PL10x/24 micrometric eyepiece, high eyepoint, focusable, rubber cup  
 M-882 WF15x/16 eyepiece, high eyepoint, focusable, with rubber cup

## Objectives & Additional Lenses

### IOS W-PLAN

- M-782 IOS LWD W-PLAN objective 4x/0.10  
 M-773 IOS LWD W-PLAN objective 40x/0.60  
 M-786 IOS LWD W-PLAN objective 60x/0.70

### IOS W-PLAN PH

- M-782.1 IOS LWD W-PLAN PH objective 4x/0.13  
 M-783N IOS LWD W-PLAN PH objective 10x/0.25  
 M-784N IOS LWD W-PLAN PH objective 20x/0.40  
 M-785 IOS LWD W-PLAN PH objective 40x/0.65

### IOS U-PLAN F

- M-800 IOS LWD U-PLAN F objective 4x/0.13  
 M-801 IOS LWD U-PLAN F objective 10x/0.30  
 M-802 IOS LWD U-PLAN F objective 20x/0.45  
 M-803 IOS LWD U-PLAN F objective 40x/0.65  
 M-804 IOS LWD U-PLAN F objective 60x/0.75

### IOS U-PLAN F PH

- M-1177 IOS LWD U-PLAN F PH objective 20x/0.45  
 M-1178 IOS LWD U-PLAN F PH objective 40x/0.65

### IOS U-PLAN MET (Brightfield)

- M-1100 IOS LWD U-PLAN MET objective 5x/0.15  
 M-1101 IOS LWD U-PLAN MET objective 10x/0.30  
 M-1102 IOS LWD U-PLAN MET objective 20x/0.45  
 M-1103 IOS LWD U-PLAN MET objective 50x/0.55  
 M-1104 IOS LWD U-PLAN MET objective 100x/0.80 (dry)

### IOS U-PLAN MET (Brightfield & Darkfield)

- M-1094 IOS LWD U-PLAN MET BD objective 5x/0.15  
 M-1095 IOS LWD U-PLAN MET BD objective 10x/0.30  
 M-1096 IOS LWD U-PLAN MET BD objective 20x/0.45  
 M-1097 IOS LWD U-PLAN MET BD objective 50x/0.55  
 M-1098 IOS LWD U-PLAN MET BD objective 100x/0.80 (dry)

### IOS U-PLAN F MET (Brightfield)

- M-1171 IOS LWD U-PLAN F MET objective 5x/0.15  
 M-1172 IOS LWD U-PLAN F MET objective 10x/0.30  
 M-1173 IOS LWD U-PLAN F MET objective 20x/0.50  
 M-1174 IOS LWD U-PLAN F MET objective 50x/0.80  
 M-1175 IOS LWD U-PLAN F MET objective 100x/0.90 (dry)

### IOS U-PLAN F MET (Brightfield & Darkfield)

- M-1180 IOS LWD U-PLAN F MET BD objective 5x/0.15  
 M-1181 IOS LWD U-PLAN F MET BD objective 10x/0.30  
 M-1182 IOS LWD U-PLAN F MET BD objective 20x/0.50  
 M-1183 IOS LWD U-PLAN F MET BD objective 50x/0.80  
 M-1184 IOS LWD U-PLAN F MET BD objective 100x/0.90 (dry)

## Condensers & Filters

- M-550 Interferential green filter IF550 (except for IM-5MET)  
 M-677ND Neutral density filter, 25% transmission (only for IM-5MET)  
 M-678ND Neutral density filter, 50% transmission (only for IM-5MET)

## Camera Adapters

- M-113.1 Ring adapter, 30mm (for monocular and binocular microscopes)  
 M-115 0.35x C-Mount projection lens  
 M-114 0.5x C-Mount projection lens  
 M-118 0.75x C-Mount projection lens  
 M-173 C-Mount projection lens for APS-C/full frame reflex cameras (trino)  
 M-620 0.35x focusable C-Mount adapter (biological microscopes)  
 M-620.1 0.5x focusable C-Mount adapter (biological microscopes)  
 M-620.2 0.65x focusable C-Mount adapter (biological microscopes)  
 M-620.3 1x focusable C-Mount adapter (biological & stereomicroscopes)  
 M-699 Universal adapter for C-Mount projection lens (trino)

## Miscellaneous

- 15104 Cleaning kit  
 CL-36 Halogen bulb 12V/100W (only for IM-5MET)  
 DC-005 TNT dust cover, extra large, 820(l)x550(h) mm  
 M-005 Micrometric slide, 26x76mm, with 2 scales (1mm/100 & 10mm/100)  
 M-641 Adapter for micromanipulator plate (only for IM-5)  
 M-793.1 Holder for Petri 38mm diameter (M-793.2 needed) (except for IM-5MET)  
 M-793.2 Holder for Terasaki and Petri 65mm diameter (except for IM-5MET)  
 M-793.3 Holder for slides and Petri 54mm diameter (except for IM-5MET)  
 M-793.4 Holder for 2+2 slides (except for IM-5MET)  
 M-793.5 Holder for metallurgical samples (only for IM-5MET)  
 M-793.6 Holder for Utermohl-Chamber (M-793.3 needed) (except for IM-5MET)  
 M-793.7 Load bearing side extension (except for IM-5MET)  
 M-870 DIC slider with Nomarski prism for reflected light (only for IM-5MET)  
 VP-IM5 IQ/OQ/PQ manual for IM-5 series

### 15104 - Cleaning kit

It cleans glass quickly and effectively, without leaving residue or odor. Ideal for precision lens or prism cleaning.



**How to connect the cameras to our microscopes.**  
 Please refer to the Adapter reference list on Digital section.

v 1.4.0 - OPTIKA reserves the right to make corrections, modifications, enhancements, improvements and other changes to its products at any time without notice.

## Headquarters and Manufacturing Facilities

**OPTIKA® S.r.l.** Via Rigla, 30 - 24010 Ponteranica (BG) - ITALY - Tel.: +39 035.571.392 - info@optikamicroscopes.com

## Optika Sales branches

**OPTIKA® Spain** spain@optikamicroscopes.com  
**OPTIKA® China** china@optikamicroscopes.com  
**OPTIKA® India** india@optikamicroscopes.com

**OPTIKA® USA** usa@optikamicroscopes.com  
**OPTIKA® Central America** camerica@optikamicroscopes.com

# POL Series



**Routine & Research Lab Polarizing Microscopes**

## 2 Polarized Light Microscopy

Polarized light microscopy is an optical microscopy technique involving polarized light. Simple techniques include illumination of the sample with polarized light. Directly transmitted or incident light can, optionally, be blocked with a polariser orientated at 90 degrees to the illumination.

These illumination techniques are most commonly used on birefringent samples where the polarized light interacts strongly with the sample and so generating contrast with the background. Polarized light microscopy is used extensively in optical mineralogy.

As polarised light passes through a birefringent sample, the phase difference between the fast and slow directions varies with the thickness, and wavelength of light used. The optical path difference (o.p.d.) is defined as

$$\text{o.p.d.} = \Delta n \times t$$

where  $t$  is the thickness of the sample.

This then leads to a phase difference between the light passing in the two vibration directions of

$$\delta = 2\pi (\Delta n \times t / \lambda)$$

For example, if the optical path difference is  $\lambda / 2$ , then the phase difference will be  $\pi$ , and so the polarisation will be perpendicular to the original, resulting in all of the light passing through the analyser for crossed polars.

If the optical path difference is  $n \times \lambda$ , then the phase difference will be  $2n \times \pi$ , and so the polarisation will be parallel to the original. This means that no light will be able to pass through the analyser which it is now perpendicular to.

The Michel-Levy Chart arises when polarised white light is passed through a birefringent sample. If the sample is of uniform thickness, then only one specific wavelength will meet the above condition described above, and be perpendicular to the direction of the analyser. This means that instead of polychromatic light being viewed at the analyser, one specific wavelength will have been removed. This information can be used in a number of ways:

- If the birefringence is known, then the thickness,  $t$ , of the sample can be determined
- If the thickness is known, then the birefringence of the sample can be determined

As the order of the optical path difference increases, then it is more likely that more wavelengths of light will be removed from the spectrum. This results in the appearance of the colour being "washed out", and it becomes more difficult to determine the properties of the sample. This, however, only occurs when the sample is relatively thick when compared to the wavelength of light.

### Icons



Field number



Incident light



Transmitted light



X-LED illuminator



Multi-Plug low voltage power supply



IOS Infinity corrected optics



Polarized light



N-PLAN Objectives  
(20mm field of view)



W-PLAN Objectives  
(22mm field of view)



U-PLAN Objectives  
(25mm field of view)



# B-383POL - Polarizing Microscope

Upright microscope for brightfield and polarizing light observations with strain-free IOS N-PLAN POL objectives. Complete of polarizer and analyzer filters, Bertrand lens for conoscopic observation, compensator plates and high-precision rotatable stages. It comes with the exclusive **X-LED<sup>3</sup>** illumination system to deliver bright and clear images, along with all the accessories to perform accurate polarization analysis in biology and materials science.

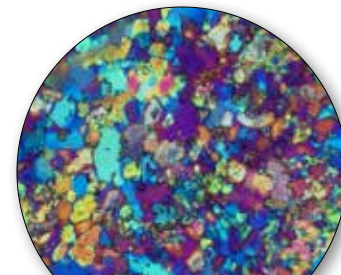

4x with First Order plate

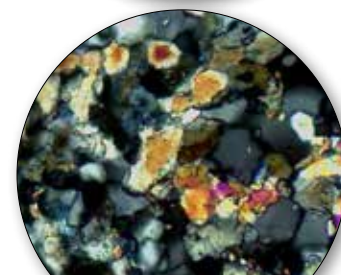

10x

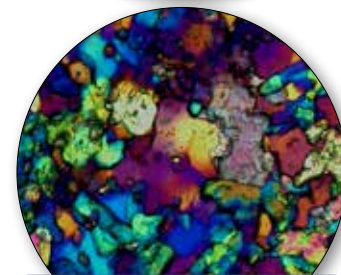

10x with First Order plate

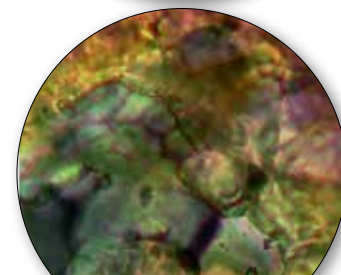

60x

Part	Description
<b>Observation mode:</b>	Brightfield, transmitted polarized light and conoscopy.
<b>Bertrand lens and polarizing attachment:</b>	Swing-out type with centering mechanism for observation in conoscopy/orthoscopy. Rotatable analyzer from 0° to 90° with graduated scale. Tint plates: 1° order red ( $\lambda$ ); $\lambda/4$ ; Quartz wedge.
<b>Head:</b>	Trinocular (fixed 50/50), 30° inclined, 360° rotating.
<b>Interpupillary distance:</b>	Adjustable between 48 and 75 mm.
<b>Dioptric adjustment:</b>	On the left eyepiece tube.
<b>Eyepieces:</b>	WF10x/20 mm, high eye-point and secured by screw. One with crosshair.
<b>Nosepiece:</b>	Quadruple revolving nosepiece, rotation on ball bearings. Centering system for each objective.

Part	Description
<b>Objectives (strain-free):</b>	IOS N-PLAN POL 4x/0.10 IOS N-PLAN POL 10x/0.25 IOS N-PLAN POL 40x/0.65 IOS N-PLAN POL 60x/0.80 All with anti-fungus treatment.
<b>Specimen stage:</b>	Rotatable stage with locking mechanism. Vernier scale with accuracy 0.1 mm. Diameter 160 mm. Specimen slide clamps.
<b>Focusing:</b>	Coaxial coarse (adjustable tension) and fine focusing mechanism with limit stop to prevent the contact between objective and specimen.
<b>Condenser:</b>	Abbe N.A. 1.25, with objective-coded iris diaphragm, focusable and centerable. With rotating polarizing filter.
<b>Transmitted illumination (Fixed Koehler type):</b>	X-LED <sup>3</sup> with white 3.6 W LED (6.300 K) with brightness control. Multi-plug 100-240Vac/6Vdc external power supply.

# B-510POL - Polarizing Microscope

Advanced routine laboratory microscope for transmitted light in brightfield and polarized light observations with strain-free IOS W-PLAN POL objectives. Complete of polarizer and analyzer filters, Bertrand lens for conoscopic observation, compensator plates and high-precision rotatable stages. It comes with the exclusive **X-LED<sup>3</sup>** illumination system to deliver bright and clear images, along with all the accessories to perform accurate polarization analysis in biology and materials science.

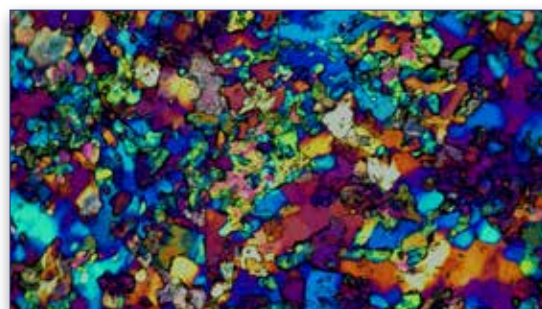

Part	Description
<b>Observation mode:</b>	Brightfield, transmitted polarized light and conoscopy.
<b>Bertrand lens and polarizing attachment:</b>	Swing-out type with centering mechanism for observation in conoscopy/orthoscopy. Rotatable analyzer from 0° to 90° with graduated scale. Tint plates: 1° order red ( $\lambda$ ); $\lambda/4$ ; Quartz wedge.
<b>Head:</b>	Trinocular (fixed 50/50), 30° inclined, 360° rotating.
<b>Interpupillary distance:</b>	Adjustable between 50 and 75 mm.
<b>Dioptric adjustment:</b>	On the left eyepiece tube.
<b>Eyepieces:</b>	WF10x/22 mm, high eye-point and with rubber cups. One with crosshair.
<b>Nosepiece:</b>	Quadruple revolving nosepiece, rotation on ball bearings. Centering system for each objective.

Part	Description
<b>Objectives (strain-free):</b>	IOS W-PLAN POL 4x/0.10    IOS W-PLAN POL 10x/0.25 IOS W-PLAN POL 20x/0.45    IOS W-PLAN POL 40x/0.65 All with anti-fungus treatment.
<b>Specimen stage:</b>	Rotatable stage with locking mechanism and centering knobs. Vernier scale with accuracy 0.1 mm. Diameter 145 mm. Specimen slide clamps.
<b>Focusing:</b>	Coaxial coarse (adjustable tension) and fine focusing mechanism with limit stop to prevent the contact between objective and specimen.
<b>Condenser:</b>	Swing-out N.A. 0.2/0.9, with iris diaphragm, focusable and centerable. With rotating polarizing filter.
<b>Transmitted illumination (Full Koehler type):</b>	X-LED <sup>3</sup> with white 3.6 W LED (6,300 K) with brightness control. Multi-plug 100-240Vac/6Vdc external power supply.

# B-510POL-I - Polarizing Microscope

Advanced routine laboratory microscope for brightfield and polarized light observations in transmitted and incident light with strain-free IOS LWD W-PLAN POL objectives. Complete of polarizer and analyzer filters, Bertrand lens for conoscopic observation, compensator plates and high-precision rotatable stages. It comes with the exclusive **X-LED<sup>3</sup>** illumination system to deliver bright and clear images, along with all the accessories to perform accurate polarization analysis in biology and materials science.

- 22
- 
- 
- 
- 
- 
- 

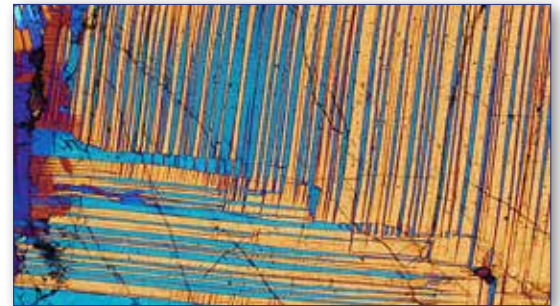

## Incident/transmitted light Objectives included

Description
IOS LWD W-PLAN POL 5x/0.12, W.D. 15.5 mm
IOS LWD W-PLAN POL 10x/0.25, W.D. 10.0 mm
IOS LWD W-PLAN POL 20x/0.40, W.D. 5.8 mm
IOS LWD W-PLAN POL 50x/0.75, W.D. 0.32 mm

Part	Description
<b>Observation mode:</b>	Brightfield, transmitted/incident polarized light and conoscopy.
<b>Epi-illumination and filters:</b>	X-LED <sup>3</sup> with white 8 W LED (6.300 K) with brightness control. With polarizer and rotating analyzer for incident illumination, aperture and field diaphragm. With additional filter holder.
<b>Bertrand lens and polarizing attachment:</b>	Swing-out type with centering mechanism for observation in conoscopy/orthoscopy. Rotatable analyzer from 0° to 90° with graduated scale. Tint plates: 1° order red ( $\lambda$ ); $\lambda/4$ ; Quartz wedge.
<b>Head:</b>	Trinocular (fixed 50/50), 30° inclined, 360° rotating.
<b>Interpupillary distance:</b>	Adjustable between 50 and 75 mm.
<b>Dioptric adjustment:</b>	On the left eyepiece tube.
<b>Eyepieces:</b>	WF10x/22 mm, high eye-point and with rubber cups. One with crosshair.
<b>Nosepiece:</b>	Quadruple revolving nosepiece, rotation on ball bearings. Centering system for each objective.

Part	Description
<b>Objectives (strain-free):</b>	IOS LWD W-PLAN POL 5x/0.12 IOS LWD W-PLAN POL 10x/0.25 IOS LWD W-PLAN POL 20x/0.40 IOS LWD W-PLAN POL 50x/0.75 All with anti-fungus treatment.
<b>Specimen stage:</b>	Rotatable stage with locking mechanism and centering knobs. Vernier scale with accuracy 0.1 mm. Diameter 145 mm. Specimen slide clamps.
<b>Focusing:</b>	Coaxial coarse (adjustable tension) and fine focusing mechanism with limit stop to prevent the contact between objective and specimen.
<b>Condenser:</b>	Swing-out N.A. 0.2/0.9, with iris diaphragm, focusable and centerable. With rotating polarizing filter.
<b>Transmitted illumination (Full Koehler type):</b>	X-LED <sup>3</sup> with white 3.6 W LED (6.300 K) with brightness control. Multi-plug 100-240Vac/6Vdc external power supply.

## ② B-1000POL - Polarizing Microscope

The modular OPTIKA B-1000 is available with transmitted polarized light, helping you working in a comfortable way during extended periods of use and performing reliable, accurate and rapid diagnosis benefiting from modularity, which gives the chance to create customized configurations tailored on customer needs. Versatile, robust, durable and sturdy, B-1000 offers premium quality optics, the state-of-the-art, exclusive **X-LED<sup>8</sup>** (8 W) illumination system, designed by OPTIKA and the Koehler diaphragm.

B-1000 gives multiple options as manual or motorized configuration.



Dedicated version for transmitted  
(**X-LED<sup>8</sup>**, 8 W)  
illumination and polarization analysis.

# B-1000POL - Configuration Chart

Build the microscope that suites your needs by choosing among the components

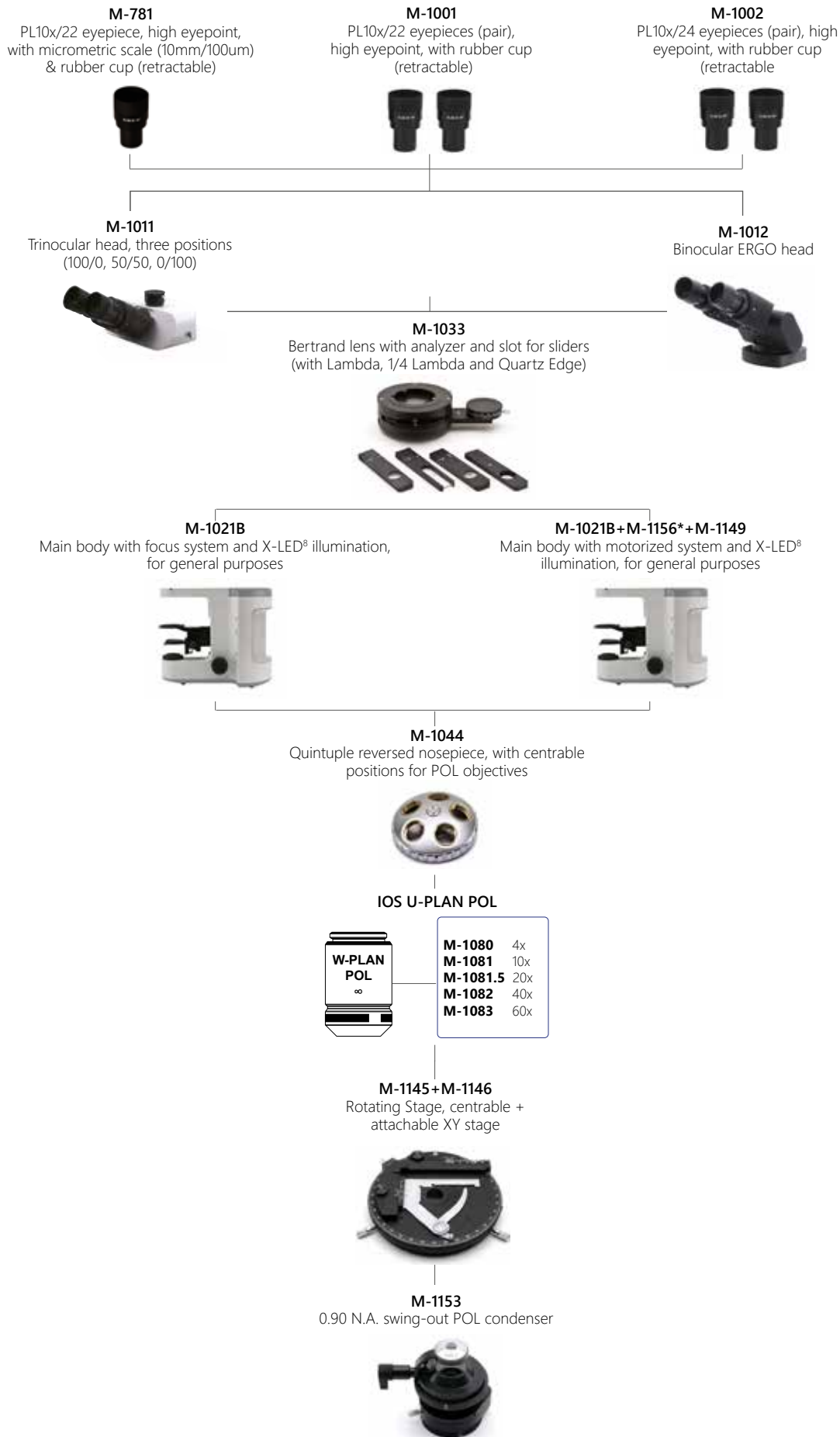

\* Code M-1156 must be added only **once** for any motorized configuration

## ② B-1000POL-I - Polarizing Microscope

The modular OPTIKA B-1000 is available with transmitted and incident polarized light, helping you working in a comfortable way during extended periods of use and performing reliable, accurate and rapid diagnosis benefiting from modularity, which gives the chance to create customized configurations tailored on customer needs. Versatile, robust, durable and sturdy, B-1000 offers premium quality optics, the state-of-the-art, exclusive **X-LED<sup>®</sup>** (8 W) illumination system, designed by OPTIKA and the Koehler diaphragm.

B-1000 gives multiple options as manual or motorized configuration.



Dedicated version for transmitted and incident illumination (**X-LED<sup>®</sup>**, 8 W)



# B-1000POL-I - Configuration Chart

Build the microscope that suites your needs by choosing among the components

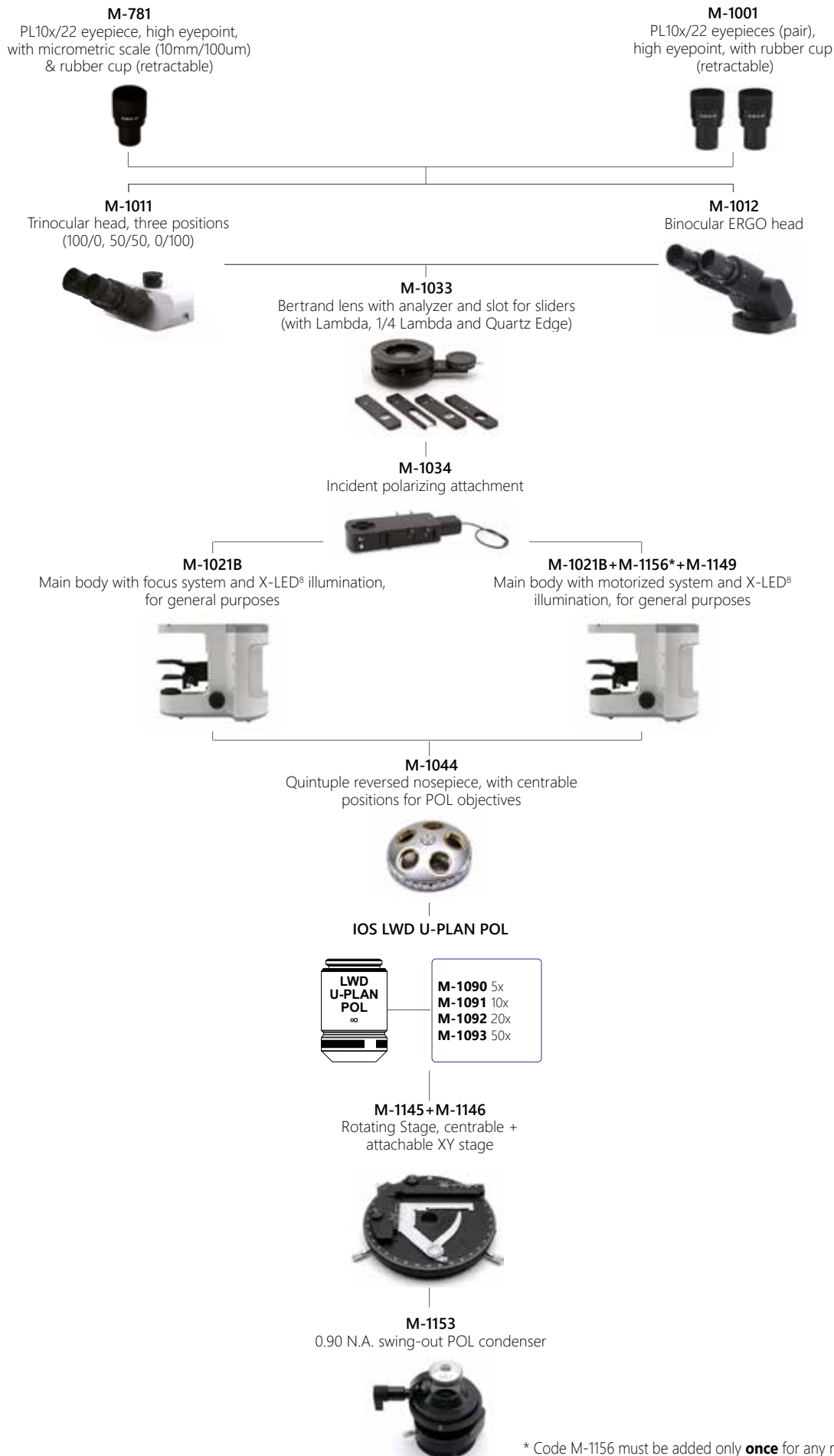

\* Code M-1156 must be added only **once** for any motorized configuration

v 1.4.0 - OPTIKA reserves the right to make corrections, modifications, enhancements, improvements and other changes to its products at any time without notice.

---

## Headquarters and Manufacturing Facilities

---

**OPTIKA® S.r.l.** Via Rigla, 30 - 24010 Ponteranica (BG) - ITALY - Tel.: +39 035.571.392 - [info@optikamicroscopes.com](mailto:info@optikamicroscopes.com)

## Optika Sales branches

---

**OPTIKA® Spain** [spain@optikamicroscopes.com](mailto:spain@optikamicroscopes.com)  
**OPTIKA® China** [china@optikamicroscopes.com](mailto:china@optikamicroscopes.com)  
**OPTIKA® India** [india@optikamicroscopes.com](mailto:india@optikamicroscopes.com)

**OPTIKA® USA** [usa@optikamicroscopes.com](mailto:usa@optikamicroscopes.com)  
**OPTIKA® Central America** [america@optikamicroscopes.com](mailto:america@optikamicroscopes.com)



# FLUO Series



**Routine & Research Lab Fluorescence Microscopes**

# Fluorescence Microscopy

## Epi Fluorescence microscopes

A fluorescence microscope is an optical microscope that uses fluorescence and phosphorescence instead of, or in addition to, reflection and absorption to study properties of organic or inorganic substances. The "fluorescence microscope" refers to any microscope that uses fluorescence to generate an image. The Epi Fluorescence microscope is equipped with a fluorescence illuminator which generates incident fluorescence light.

## Principle

The specimen is illuminated with light of a specific wavelength (or wavelengths) which is absorbed by the fluorophores, causing them to emit light of longer wavelengths (i.e., of a different color than the absorbed light). The illumination light is separated from the much weaker emitted fluorescence through the use of a spectral emission filter. Typical components of a fluorescence microscope are a light source (HBO mercury-vapor lamps are common; more advanced forms are high-power LEDs), the excitation filter, the dichroic mirror, and the emission filter. The filters and the dichroic mirror are chosen to match the spectral excitation and emission characteristics of the fluorophore used to label the specimen. In this manner, the distribution of a single fluorophore (color) is imaged at a time. Multi-color images of several types of fluorophores must be composed by combining several single-color images.

Most fluorescence microscopes in use are epifluorescence microscopes, where excitation of the fluorophore and detection of the fluorescence are done through the same light path (through the objective). These microscopes are widely used in biology and are the basis for more advanced microscope designs.

## Epifluorescence microscopy

The majority of fluorescence microscopes, especially those used in the life sciences, are of the epifluorescence design. Light of the excitation wavelength illuminates the specimen through the objective lens. The fluorescence emitted by the specimen is focused to the detector by the same objective that is used for the excitation which for greater resolution will need objective lens with higher numerical aperture. Since most of the excitation light is transmitted through the specimen, only reflected excitatory light reaches the objective together with the emitted light and the epifluorescence method therefore gives a high signal-to-noise ratio. The dichroic beamsplitter acts as a wavelength specific filter, transmitting fluoresced light through to the eyepiece or detector, but reflecting any remaining excitation light back towards the source.

## Icons

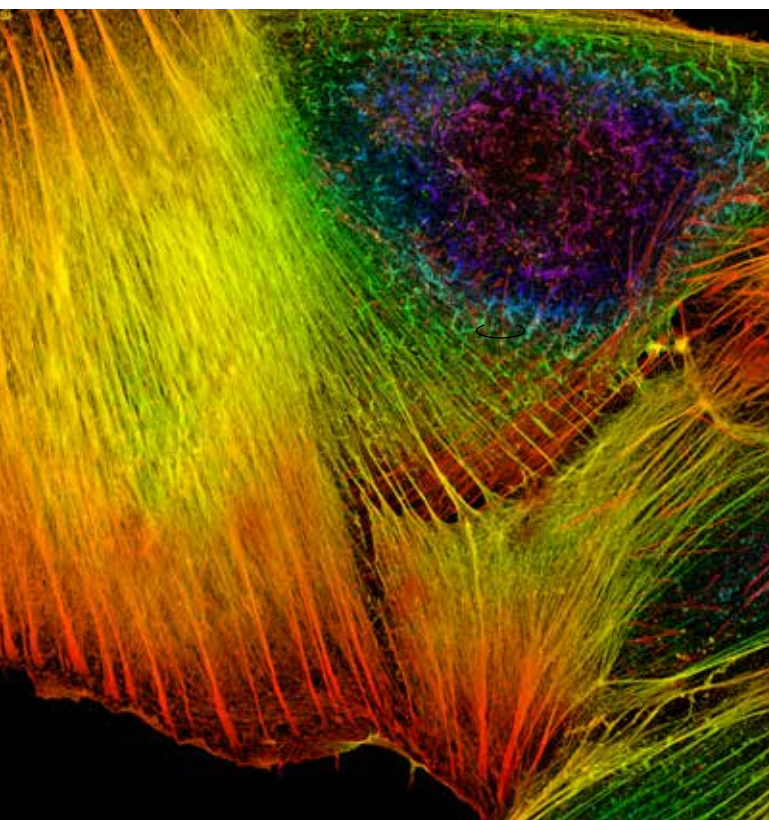

Field number



Oil/Water 100x objective



Incident light



Transmitted light



X-LED illuminator



Multi-Plug low voltage power supply



IOS Infinity corrected optics



Fluorescence



Phase contrast



N-PLAN Objectives  
(20mm field of view)



W-PLAN Objectives  
(22mm field of view)



U-PLAN Objectives  
(25mm field of view)

# B-290LD - LED Fluorescence Microscopes



Fluorescence binocular and trinocular microscopes especially designed for tuberculosis and malaria analysis.

**Observation mode:** Brightfield.

**Head:** Binocular or trinocular, 360° rotating and 30° inclined. Interpupillary distance 48-75mm.

**Dioptric adjustment:** On the left eyepiece tube.

**Eyepieces:** WF10x/20 mm, high eye-point and secured by a screw.

**Nosepiece:** Quadruple revolving nosepiece, rotation on ball bearings.

**Specimen stage:** Double layer rackless mechanical sliding stage, 150x139 mm, 75x33 mm X-Y movement range. Vernier scale on the two axes, accuracy: 0.1 mm.

**Focusing:** Coaxial coarse and fine focusing mechanism with limit stop to prevent the contact between objective and specimen. Adjustable tension of coarse focusing knob.

**Condenser:** Abbe N.A. 1.25, with objective-coded iris diaphragm, focusable and centerable.

**Brightfield Illumination (Fixed Koehler type):** X-LED<sup>3</sup> with white 3.6 W LED (6,300 K) and light intensity control.

Multi-plug 100-240Vac/6Vdc external power supply.

**Fluorescence Illumination:** Extra efficiency LED, with light intensity control. Peak wavelength: 465 nm, Power: 3.6W.

**Epi Fluorescence Attachment:** Slider with 3 positions (2 fluorescence, 1 brightfield), with 1 included filterset: Fluorescence B: EX 460-490, DM 505, EM 515LP: Acridine Yellow, Acridine Orange, Auramine, DiO, DTAF, FITC, GFP, YFP, etc.

**Part number: B-292LD1.50**

Equipped with binocular head and following objectives:  
 IOS N-PLAN 10x/0.25 (Cover/No Cover), with anti-fungus treatment  
 IOS N-PLAN 20x/0.40 (Cover/No Cover), with anti-fungus treatment  
 IOS N-PLAN 40x/0.65 (Cover/No Cover), with anti-fungus treatment  
 IOS W-PLAN MET 50x/0.75 (No Cover), with anti-fungus treatment.

**Part number: B-293LD1.50**

Trinocular version of B-292LD1.50.

**Part number: B-292LD1**

Equipped with binocular head and following objectives:  
 IOS N-PLAN 10x/0.25 (Cover/No Cover), with anti-fungus treatment  
 IOS N-PLAN 20x/0.40 (Cover/No Cover), with anti-fungus treatment  
 IOS N-PLAN 40x/0.65 (Cover/No Cover), with anti-fungus treatment  
 IOS W-PLAN 100x/0.80 (No Cover, Dry), with anti-fungus treatment.

**Part number: B-293LD1**

Trinocular version of B-292LD1.

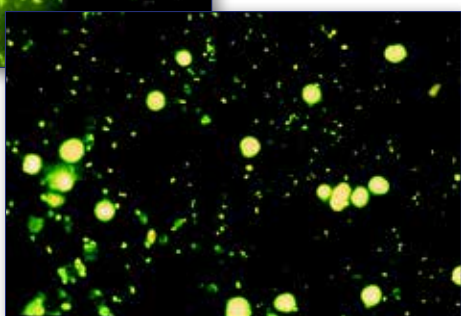
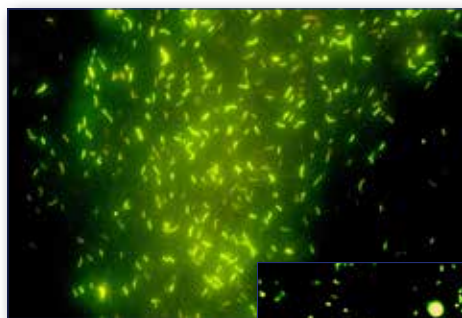

**Standard filterset**

Name	Excitation filter (nm)	Dichroic mirror cut-off (nm)	Emission filter (nm)
B (Blue)	460 – 490	505	515LP

# B-383LD1 - LED Fluorescence Microscope

Entry-level laboratory upright microscope for brightfield and fluorescence observations with IOS N-PLAN objectives. The extremely powerful LED fluorescence illuminator is combined with blue excitation filter set for the visualization of the following fluorochromes: Acridine Yellow, Acridine Orange, Auramine, DiO, DTAF, FITC, GFP, YFP, etc. LED fluorescence ensures unparalleled convenience eliminating warm-up/cool-down times and all the inconveniences related lamp replacement and adjustment. Transmitted light through the exclusive **X-LED<sup>3</sup>** to ensure great-looking, rich and high-quality specimen view.



4x

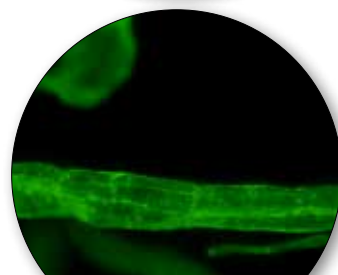

10x

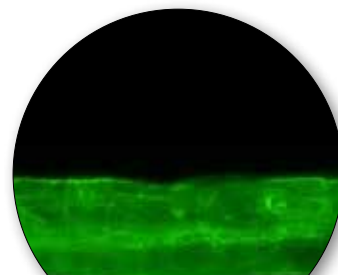

20x

## Standard filterset

Name	Excitation filter (nm)	Dichroic mirror cut-off (nm)	Emission filter (nm)
B Blue	460 – 490	505	515LP

Part	Description
<b>Observation mode:</b>	Brightfield, LED fluorescence.
<b>Epi-illumination and filter:</b>	High-power blue LED with brightness control. 3-position filter holder; blue included.
<b>Head:</b>	Trinocular (fixed 50/50), 30° inclined, 360° rotating.
<b>Interpupillary distance:</b>	Adjustable between 48 and 75 mm.
<b>Dioptric adjustment:</b>	On the left eyepiece tube.
<b>Eyepieces:</b>	WF10x/20 mm, high eye-point and secured by screw.
<b>Nosepiece:</b>	Quintuple revolving nosepiece, rotation on ball bearings.
<b>Objectives:</b>	IOS N-PLAN 4x/0.10      IOS N-PLAN 10x/0.25 IOS N-PLAN 20x/0.40      IOS N-PLAN 40x/0.65 IOS N-PLAN 100x/1.25 (Oil/Water) All with anti-fungus treatment.

Part	Description
<b>Specimen stage:</b>	Double layer rackless mechanical stage, 233x147 mm, 78x54 mm X-Y range.
<b>Focusing:</b>	Coaxial coarse (adjustable tension) and fine focusing mechanism with limit stop to prevent the contact between objective and specimen.
<b>Condenser:</b>	Abbe N.A. 1.25, with objective-coded iris diaphragm, focusable and centerable.
<b>Transmitted illumination (Fixed Koehler type):</b>	X-LED <sup>3</sup> with white 3.6 W LED (6,300K) with brightness control. Multi-plug 100-240Vac/6Vdc external power supply.

# B-383LD2 - LED Fluorescence Microscope

Laboratory upright microscope for brightfield and fluorescence observations with IOS N-PLAN objectives. The extremely powerful LED fluorescence illuminator is combined with blue and green excitation filter set for the visualization of the following fluorochromes: Acridine Yellow, Acridine Orange, Auramine, DiO, DTAF, FITC, GFP, YFP, etc. (blue) plus Rhodamine, Texas Red and TRITC (green). LED fluorescence ensures unparalleled convenience eliminating warm-up/cool-down times and all the inconveniences related lamp replacement and adjustment. Transmitted light through the exclusive **X-LED<sup>3</sup>** to ensure great-looking, rich and high-quality specimen view.

-  20
- 
- 
- 
- 
- 
- 
- 
- 

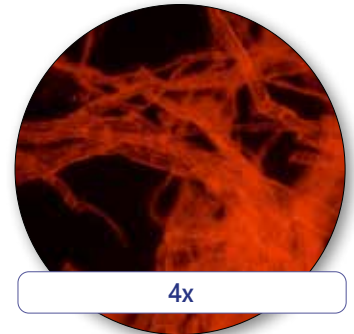

4x



10x

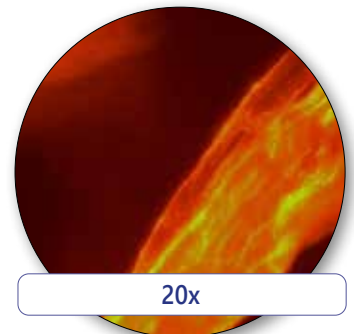

20x

### Standard filterset

Name	Excitation filter (nm)	Dichroic mirror cut-off (nm)	Emission filter (nm)
B Blue	460 - 490	505	515LP
G Green	510 - 550	570	575LP

Part	Description
<b>Observation mode:</b>	Brightfield, LED fluorescence.
<b>Epi-illumination and filters:</b>	High-power wide spectrum LED with brightness control. 3-position filter holder; blue and green included.
<b>Head:</b>	Trinocular (fixed 50/50), 30° inclined, 360° rotating.
<b>Interpupillary distance:</b>	Adjustable between 48 and 75 mm.
<b>Dioptric adjustment:</b>	On the left eyepiece tube.
<b>Eyepieces:</b>	WF10x/20 mm, high eye-point and secured by screw.
<b>Nosepiece:</b>	Quintuple revolving nosepiece, rotation on ball bearings.
<b>Objectives:</b>	IOS N-PLAN 4x/0.10      IOS N-PLAN 10x/0.25 IOS N-PLAN 20x/0.40    IOS N-PLAN 40x/0.65 IOS N-PLAN 100x/1.25 (Oil/Water) All with anti-fungus treatment.

Part	Description
<b>Specimen stage:</b>	Double layer rackless mechanical stage, 233x147 mm, 78x54 mm X-Y range.
<b>Focusing:</b>	Coaxial coarse (adjustable tension) and fine focusing mechanism with limit stop to prevent the contact between objective and specimen.
<b>Condenser:</b>	Abbe N.A. 1.25, with objective-coded iris diaphragm, focusable and centerable.
<b>Transmitted illumination (Fixed Koehler type):</b>	X-LED <sup>3</sup> with white 3.6 W LED (6,300K) with brightness control. Multi-plug 100-240Vac/6Vdc external power supply.

# B-383FL - HBO Fluorescence Microscope

Laboratory upright microscope for brightfield and fluorescence observations with IOS N-PLAN objectives.

The HBO fluorescence illuminator provides an outstanding flexibility of use, standing the blue and green filter sets (supplied as standard) for Auramine, FITC, GFP and YFP (with blue filter set) plus Rhodamine, Texas Red and TRITC (with the green one), yet giving the possibility to combine any other specific filter sets for future upgrade. Transmitted light through the exclusive **X-LED<sup>3</sup>** to ensure great-looking, rich and high-quality specimen view.



20

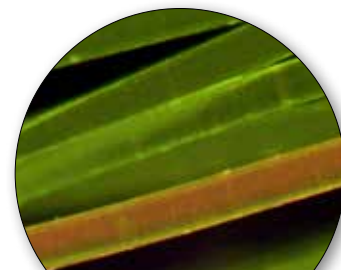

10x - Blue excitation



10x - Green excitation

## Standard filterset

Name	Excitation filter (nm)	Dichroic mirror cut-off (nm)	Emission filter (nm)
B Blue	460 - 490	505	515LP
G Green	510 - 550	570	575LP



Part	Description
<b>Observation mode:</b>	Brightfield, HBO fluorescence.
<b>Epi-illumination and filters:</b>	HBO 100 W high pressure mercury lamp. 3-position filter holder; blue and green included.
<b>Head:</b>	Trinocular (fixed 50/50), 30° inclined, 360° rotating.
<b>Interpupillary distance:</b>	Adjustable between 48 and 75 mm.
<b>Dioptric adjustment:</b>	On the left eyepiece tube.
<b>Eyepieces:</b>	WF10x/20 mm, high eye-point and secured by screw.
<b>Nosepiece:</b>	Quintuple revolving nosepiece, rotation on ball bearings.
<b>Objectives:</b>	IOS N-PLAN 4x/0.10      IOS N-PLAN 10x/0.25 IOS N-PLAN 20x/0.40    IOS N-PLAN 40x/0.65 IOS N-PLAN 100x/1.25 (Oil/Water) All with anti-fungus treatment.

Part	Description
<b>Specimen stage:</b>	Double layer rackless mechanical stage, 233x147 mm, 78x54 mm X-Y range.
<b>Focusing:</b>	Coaxial coarse (adjustable tension) and fine focusing mechanism with limit stop to prevent the contact between objective and specimen.
<b>Condenser:</b>	Abbe N.A. 1.25, with objective-coded iris diaphragm, focusable and centerable.
<b>Transmitted illumination (Fixed Koehler type):</b>	X-LED <sup>3</sup> with white 3.6 W LED (6,300K) with brightness control. Multi-plug 100-240Vac/6Vdc external power supply.

# B-510LD1 - LED Fluorescence Microscope

Advanced routine fluorescence microscope for transmitted brightfield and fluorescence observations with IOS W-PLAN objectives. The extremely powerful LED fluorescence illuminator is combined with blue excitation filter set for the visualization of the following fluorochromes: Acridine Yellow, Acridine Orange, Auramine, DiO, DTAF, FITC, GFP, YFP, etc. LED fluorescence ensures unparalleled convenience eliminating warm-up/cool-down times and all the inconveniences related lamp replacement and adjustment. Transmitted light through the exclusive **X-LED<sup>3</sup>** to ensure great-looking, rich and high-quality specimen view.

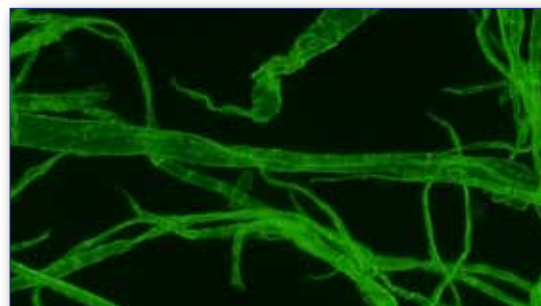

Standard filterset

Name	Excitation filter (nm)	Dichroic mirror cut-off (nm)	Emission filter (nm)
B Blue	460 – 490	505	515LP

Part	Description
<b>Observation mode:</b>	Brightfield, LED fluorescence.
<b>Epi-illumination and filter:</b>	High-power blue LED with brightness control. 3-position filter holder; blue included.
<b>Head:</b>	Trinocular (3-position 100/0, 50/50, 0/100), 30° inclined, 360° rotating.
<b>Interpupillary distance:</b>	Adjustable between 50 and 75 mm.
<b>Dioptric adjustment:</b>	On the left eyepiece tube.
<b>Eyepieces:</b>	WF10x/22 mm, high eye-point and with rubber cups.
<b>Nosepiece:</b>	Quintuple revolving nosepiece, rotation on ball bearings.
<b>Objectives:</b>	IOS W-PLAN 4x/0.10      IOS W-PLAN 10x/0.25 IOS W-PLAN 40x/0.65    IOS W-PLAN 100x/1.25 (Oil) All with anti-fungus treatment.

Part	Description
<b>Specimen stage:</b>	Double layer rackless mechanical stage, 233x147 mm, 78x54 mm X-Y range.
<b>Focusing:</b>	Coaxial coarse (adjustable tension) and fine focusing mechanism with limit stop to prevent the contact between objective and specimen.
<b>Condenser:</b>	Swing-out N.A. 0.2/0.9, with iris diaphragm, focusable and centerable.
<b>Transmitted illumination (Full Koehler type):</b>	X-LED <sup>3</sup> with white 3.6 W LED (6,300K) with brightness control. Multi-plug 100-240Vac/6Vdc external power supply.

# B-510LD2 - LED Fluorescence Microscope

Advanced routine fluorescence microscope for transmitted brightfield and fluorescence observations with IOS W-PLAN objectives. The extremely powerful LED fluorescence illuminator is combined with blue and green excitation filter set for the visualization of the following fluorochromes: Acridine Yellow, Acridine Orange, Auramine, DiO, DTAF, FITC, GFP, YFP, etc. (blue) plus Rhodamine, Texas Red and TRITC (green). LED fluorescence ensures unparalleled convenience eliminating warm-up/cool-down times and all the inconveniences related lamp replacement and adjustment. Transmitted light through the exclusive **X-LED<sup>3</sup>** to ensure great-looking, rich and high-quality specimen view.

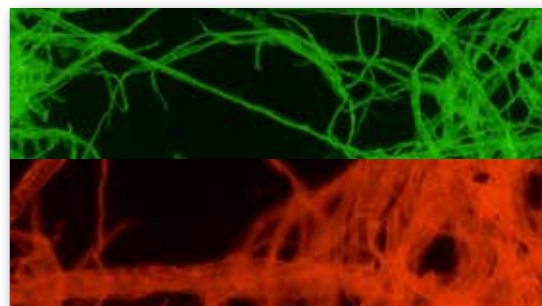

## Standard filterset

Name	Excitation filter (nm)	Dichroic mirror cut-off (nm)	Emission filter (nm)
B Blue	460 - 490	505	515LP
G Green	510 - 550	570	575LP

Part	Description
<b>Observation mode:</b>	Brightfield, LED fluorescence.
<b>Epi-illumination and filters:</b>	High-power wide spectrum LED with brightness control. 3-position filter holder; blue and green included.
<b>Head:</b>	Trinocular (3-position 100/0, 50/50, 0/100), 30° inclined, 360° rotating.
<b>Interpupillary distance:</b>	Adjustable between 50 and 75 mm.
<b>Dioptric adjustment:</b>	On the left eyepiece tube.
<b>Eyepieces:</b>	WF10x/22 mm, high eye-point and with rubber cups.
<b>Nosepiece:</b>	Quintuple revolving nosepiece, rotation on ball bearings.
<b>Objectives:</b>	IOS W-PLAN 4x/0.10      IOS W-PLAN 10x/0.25 IOS W-PLAN 40x/0.65    IOS W-PLAN 100x/1.25 (Oil) All with anti-fungus treatment.

Part	Description
<b>Specimen stage:</b>	Double layer rackless mechanical stage, 233x147 mm, 78x54 mm X-Y range.
<b>Focusing:</b>	Coaxial coarse (adjustable tension) and fine focusing mechanism with limit stop to prevent the contact between objective and specimen.
<b>Condenser:</b>	Swing-out N.A. 0.2/0.9, with iris diaphragm, focusable and centerable.
<b>Transmitted illumination (Full Koehler type):</b>	X-LED <sup>3</sup> with white 3.6 W LED (6,300K) with brightness control. Multi-plug 100-240Vac/6Vdc external power supply.



# B-510FL - HBO Fluorescence Microscope

Advanced routine laboratory microscope for brightfield and fluorescence observations with Semi-Apo IOS W-PLAN F objectives to enhance the visibility of the sample and increase the overall contrast. The **HBO fluorescence** illuminator provides an outstanding flexibility of use, standing the blue and green filter sets (supplied as standard) for Auramine, FITC, GFP and YFP (with blue filter set) plus Rhodamine, Texas Red and TRITC (with the green one), yet giving the possibility to combine any other specific filter sets for future upgrade. Transmitted light through the exclusive **X-LED<sup>3</sup>** to ensure great-looking, rich and high-quality specimen view.

-  22
-  X-LED<sup>3</sup>
-  IOS  
∞
-  W-PLAN
-  FL

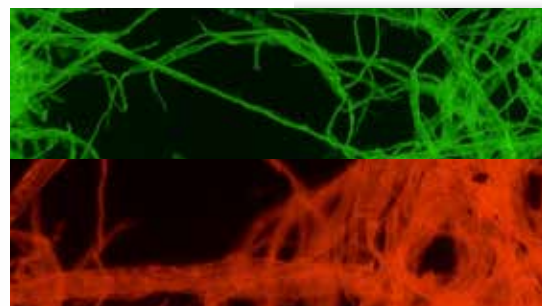

Standard filterset

Name	Excitation filter (nm)	Dichroic mirror cut-off (nm)	Emission filter (nm)
B Blue	460 - 490	505	515LP
G Green	510 - 550	570	575LP



Additional filterset (optional)

Name	Excitation filter (nm)	Dichroic mirror cut-off (nm)	Emission filter (nm)
V (Violet)	390 - 420	440	455LP
UV	325 - 375	415	435LP

Part	Description
<b>Observation mode:</b>	Brightfield, HBO fluorescence.
<b>Epi-illumination and filter:</b>	HBO 100 W high pressure mercury lamp. 4-position filter holder; blue & green included.
<b>Head:</b>	Trinocular (3-position 100/0, 50/50, 0/100), 30° inclined, 360° rotating.
<b>Interpupillary distance:</b>	Adjustable between 50 and 75 mm.
<b>Dioptric adjustment:</b>	On the left eyepiece tube.
<b>Eyepieces:</b>	WF10x/22 mm, high eye-point and with rubber cups.
<b>Nosepiece:</b>	Quintuple revolving nosepiece, rotation on ball bearings.
<b>Objectives:</b>	IOS W-PLAN F 4x/0.13      IOS W-PLAN F 10x/0.30 IOS W-PLAN F 20x/0.50    IOS W-PLAN F 40x/0.75 All with anti-fungus treatment.

Part	Description
<b>Specimen stage:</b>	Double layer rackless mechanical stage, 233x147 mm, 78x54 mm X-Y range.
<b>Focusing:</b>	Coaxial coarse (adjustable tension) and fine focusing mechanism with limit stop to prevent the contact between objective and specimen.
<b>Condenser:</b>	Swing-out N.A. 0.2/0.9, with iris diaphragm, focusable and centerable.
<b>Transmitted illumination (Full Koehler type):</b>	X-LED <sup>3</sup> with white 3.6 W LED (6,300K) with brightness control. Multi-plug 100-240Vac/6Vdc external power supply.

# 2 B-1000FL-LED - LED Fluorescence Microscope

The modular OPTIKA B-1000 can stand a LED fluorescence attachment, helping you working in a comfortable way during extended periods of use and performing reliable, accurate and rapid diagnosis benefiting from modularity, which gives the chance to create customized configurations tailored on customer needs. Versatile, robust, durable and sturdy, B-1000 offers premium quality optics (including Semi-Apo objectives), the state-of-the-art, exclusive **X-LED<sup>®</sup>** (8 W) illumination system, designed by OPTIKA and the Koehler diaphragm. B-1000 gives multiple options as manual or motorized configuration, with a variety of objectives, stages and condensers.



### Innovative, LED Fluorescence

- » Recommended for routine applications
- » Cost-effective, money saving technology
- » Ready for immediate operation
- » Eliminate warm-up/cool-down times
- » Forget lamp replacement & centering

### Standard filterset

Name	Excitation filter (nm)	Dichroic mirror cut-off (nm)	Emission filter (nm)
B Blue	450 - 490	495	520LP
G Green	500 - 540	560	575LP

# B-1000FL-LED - Configuration Chart

Build the microscope that suites your needs by choosing among the components

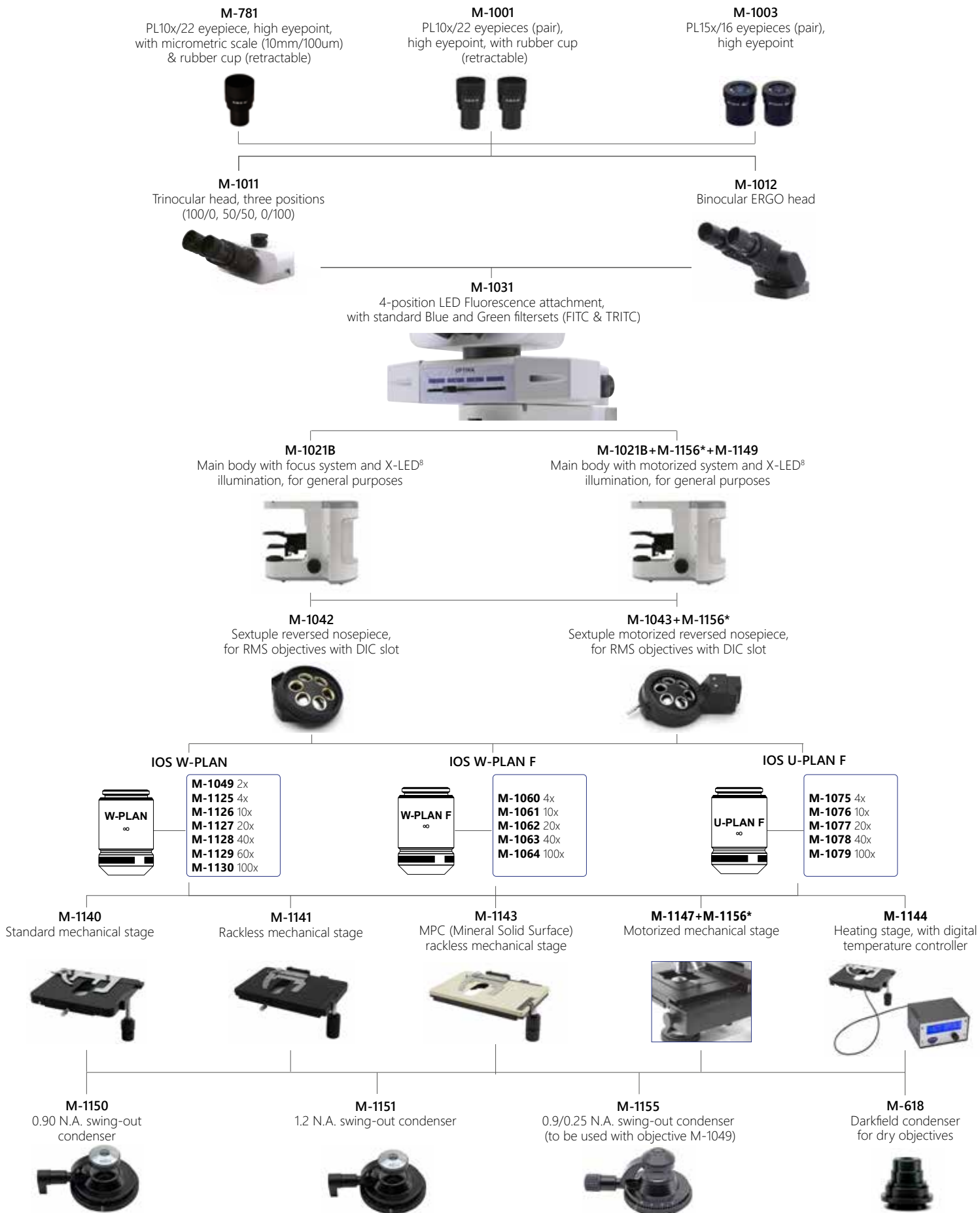

\* Code M-1156 must be added only **once** for any motorized configuration

# 2 OPTIKA B-1000FL-HBO - HBO Fluorescence Microscope

The modular OPTIKA B-1000 can stand a HBO fluorescence attachment, helping you working in a comfortable way during extended periods of use and performing reliable, accurate and rapid diagnosis benefiting from modularity, which gives the chance to create customized configurations tailored on customer needs. Versatile, robust, durable and sturdy, B-1000 offers premium quality optics (including Semi-Apo objectives), the state-of-the-art, exclusive **X-LED<sup>8</sup>** (8 W) illumination system, designed by OPTIKA and the Koehler diaphragm. B-1000 gives multiple options as manual or motorized configuration, with a variety of objectives, stages and condensers.

## Standard filterset

Name	Excitation filter (nm)	Dichroic mirror cut-off (nm)	Emission filter (nm)
<b>B Blue</b>	460 - 490	500	520LP
<b>G Green</b>	510 - 550	570	590LP

## Additional filterset (optional)

Name	Excitation filter (nm)	Dichroic mirror cut-off (nm)	Emission filter (nm)
<b>V (Violet)</b>	400 - 410	455	455LP
<b>UV</b>	330 - 385	400	420LP



# B-1000FL-HBO - Configuration Chart

Build the microscope that suites your needs by choosing among the components

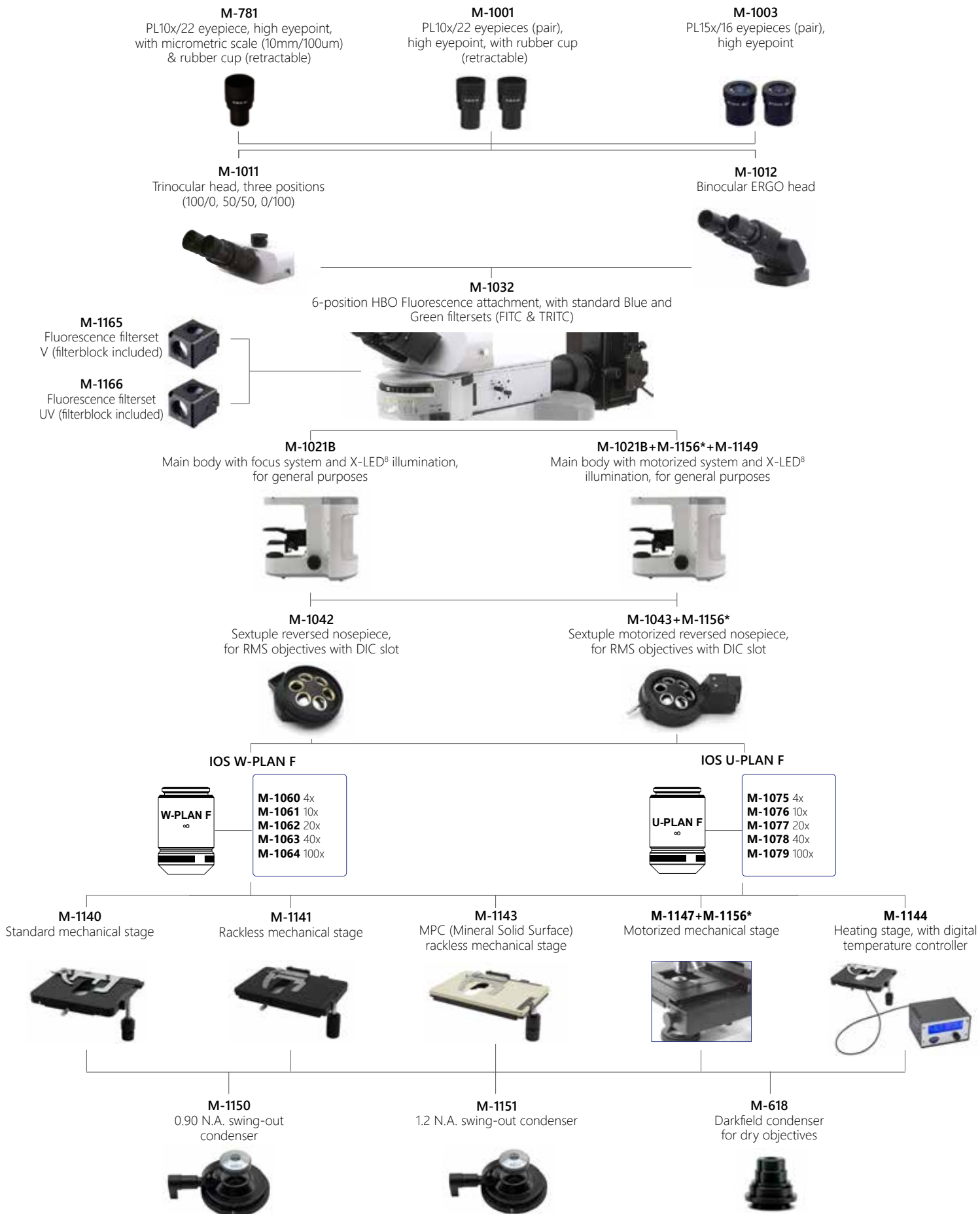

\* Code M-1156 must be added only **once** for any motorized configuration

# Fluorescence Filtersets

Name	Excitation filter (nm)	Dichroic mirror cut-off (nm)	Emission filter (nm)
<b>B (Blue)</b>	460 – 490	505	515LP
<b>G (Green)</b>	510 – 550	570	575LP
<b>V (Violet) optional</b>	385 – 425	440	455LP
<b>UV (Ultraviolet) optional</b>	325 – 375	415	435LP

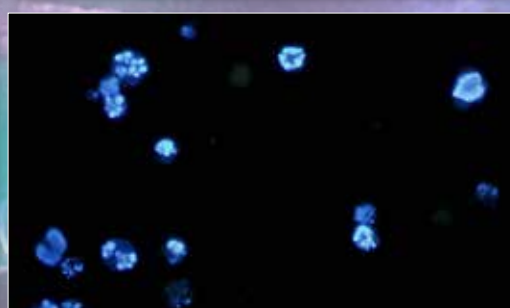
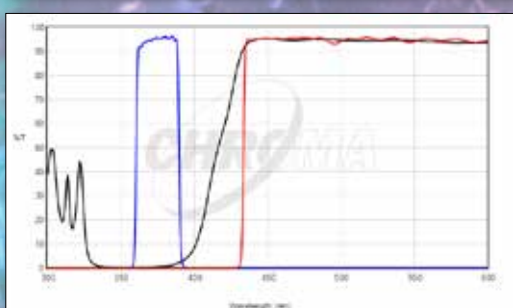
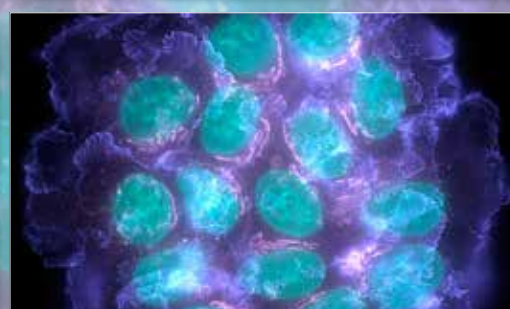
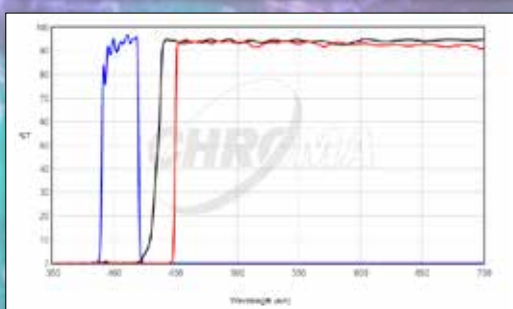
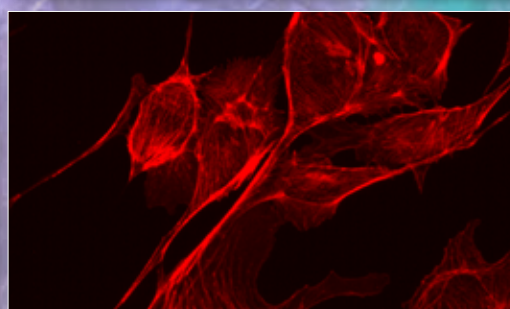
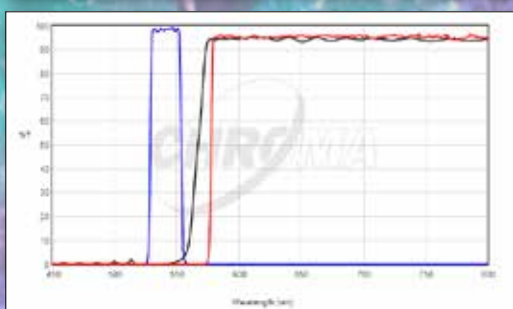
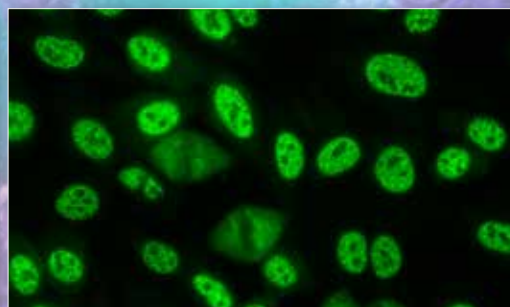
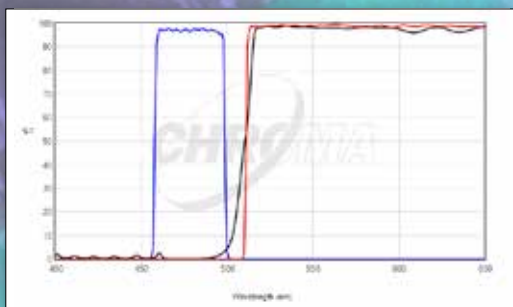

**MANY MORE FILTERSETS  
AVAILABLE ON REQUEST**

**CHROMA TECHNOLOGY CORP**  
THE WORLD'S FINEST OPTICAL FILTERS

# IM-3LD - LED Fluorescence Microscope

Routine inverted fluorescence microscope for transmitted brightfield, phase contrast and fluorescence observations with IOS LWD W-PLAN PH objectives.

The LED fluorescence illuminator is combined with blue and green excitation filter set for the visualization of the following fluorochromes: Acridine Yellow, Acridine Orange, Auramine, DiO, DTAF, FITC, GFP, YFP, etc. (blue) plus Rhodamine, Texas Red and TRITC (green). LED fluorescence ensures unparalleled convenience eliminating warm-up/cool-down times and all the inconveniences related lamp replacement and adjustment. Transmitted light through the exclusive **X-LED<sup>®</sup>** to ensure great-looking, rich and high-quality specimen view.

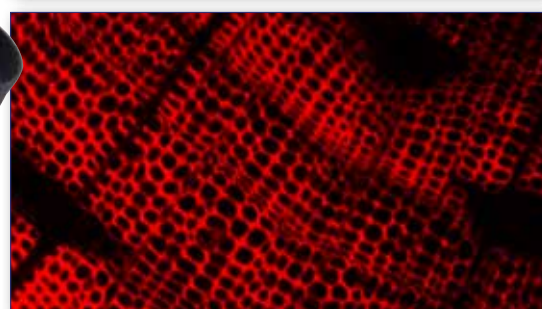
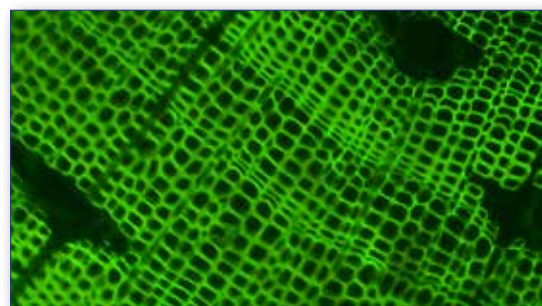

### Standard filterset

Name	Excitation filter (nm)	Dichroic mirror cut-off (nm)	Emission filter (nm)
B Blue	450 - 490	495	520LP
G Green	540 - 580	585	590LP

Part	Description
<b>Observation mode:</b>	Brightfield, phase contrast, LED fluorescence.
<b>Epi-illumination and filter:</b>	High-power 18 W LED with brightness control. 3-position filter holder; blue and green.
<b>Head:</b>	Trinocular (2-position 100/0, 0/100), 45° inclined.
<b>Interpupillary distance:</b>	Adjustable between 50 and 75 mm.
<b>Dioptric adjustment:</b>	On the left eyepiece tube.
<b>Eyepieces:</b>	WF10x/22 mm, high eye-point and with rubber cups.
<b>Nosepiece:</b>	Quintuple revolving nosepiece, rotation on ball bearings.
<b>Objectives:</b>	IOS LWD W-PLAN PH 10x/0.25 IOS LWD W-PLAN PH 20x/0.40 IOS LWD W-PLAN PH 40x/0.65 All with anti-fungus treatment.

Part	Description
<b>Specimen stage:</b>	Fixed stage, 250x160 mm, with glass and metal stage inserts.
<b>Focusing:</b>	Coaxial coarse (adjustable tension) and fine focusing mechanism with limit stop to prevent the contact between objective and specimen.
<b>Condenser:</b>	LWD pre-centered condenser, N.A. 0.30, W.D. 72 mm. With 4x/10x, 20x/40x phase contrast slider and brightfield. Removable to extend the working distance up to 150 mm.
<b>Transmitted illumination:</b>	X-LED <sup>®</sup> with white 8 W LED (6,300K) with brightness control. With aperture diaphragm. 100-240Vac/24Vdc external power supply.

# IM-3F - HBO Fluorescence Microscope

Routine inverted fluorescence microscope for transmitted brightfield, phase contrast and fluorescence observations with IOS LWD W-PLAN objectives.

The HBO fluorescence illuminator is combined with blue and green excitation filter set for the visualization of the following fluorochromes: Acridine Yellow, Acridine Orange, Auramine, DiO, DTAF, FITC, GFP, YFP, etc. (blue) plus Rhodamine, Texas Red and TRITC (green).

Transmitted light through the exclusive **X-LED<sup>®</sup>** to ensure great-looking, rich and high-quality specimen view.

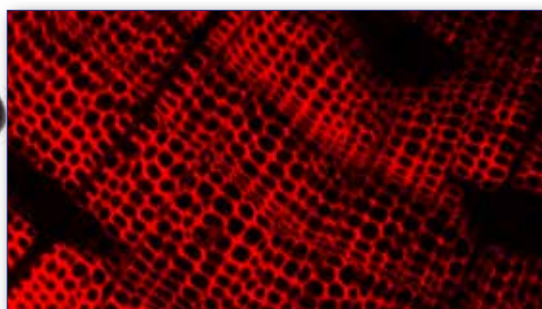
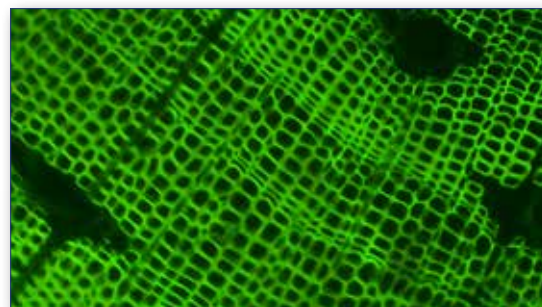

## Standard filtersets

Name	Excitation filter (nm)	Dichroic mirror cut-off (nm)	Emission filter (nm)
B (Blue)	450 – 490	495	520LP
G (Green)	540 – 580	585	590LP

Part	Description
<b>Observation mode:</b>	Brightfield, phase contrast, HBO fluorescence.
<b>Epi-illumination and filter:</b>	HBO 100 W high pressure mercury lamp. 3-position filter holder; blue & green included.
<b>Head:</b>	Trinocular (2-position 100/0, 0/100), 45° inclined.
<b>Interpupillary distance:</b>	Adjustable between 50 and 75 mm.
<b>Dioptric adjustment:</b>	On the left eyepiece tube.
<b>Eyepieces:</b>	WF10x/22 mm, high eye-point and with rubber cups.
<b>Nosepiece:</b>	Quintuple revolving nosepiece, rotation on ball bearings.
<b>Objectives:</b>	IOS LWD W-PLAN 4x/0.13 IOS LWD W-PLAN PH 10x/0.25 IOS LWD W-PLAN PH 20x/0.40 IOS LWD W-PLAN 40x/0.60 All with anti-fungus treatment.

Part	Description
<b>Specimen stage:</b>	Fixed stage, 250x160 mm, with glass and metal stage inserts.
<b>Focusing:</b>	Coaxial coarse (adjustable tension) and fine focusing mechanism with limit stop to prevent the contact between objective and specimen.
<b>Condenser:</b>	LWD pre-centered condenser, N.A. 0.30, W.D. 72 mm. With 4x/10x, 20x/40x phase contrast slider and brightfield. Removable to extend the working distance up to 150 mm.
<b>Transmitted illumination:</b>	X-LED <sup>®</sup> with white 8 W LED (6,300K) with brightness control. With aperture diaphragm. Multi-plug 100-240Vac/6Vdc external power supply.



# IM-3FL4 - HBO Fluorescence Microscope

Advanced inverted microscope for brightfield and fluorescence observations with Semi-Apo IOS LWD U-PLAN F objectives to enhance the visibility of the sample and increase the overall contrast. The HBO fluorescence illuminator provides an outstanding flexibility of use, standing the blue and green filter sets (supplied as standard) for Auramine, FITC, GFP and YFP (with blue filter set) plus Rhodamine, Texas Red and TRITC (with the green one), yet giving the possibility to combine any other specific filter sets for future upgrade. Transmitted light through the exclusive **X-LED<sup>8</sup>** to ensure great-looking, rich and high-quality specimen view.

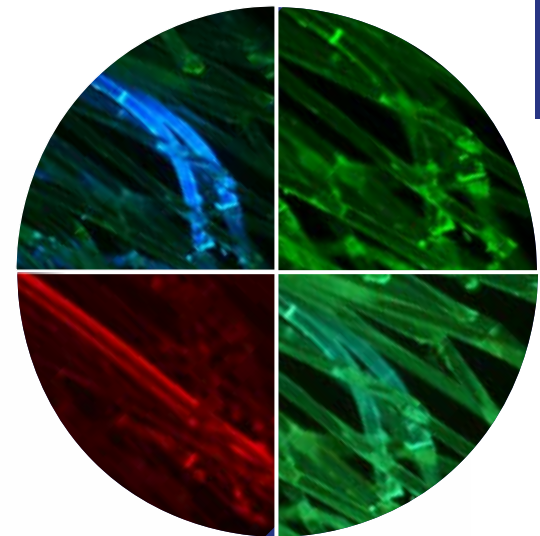

### Standard filterset

Name	Excitation filter (nm)	Dichroic mirror cut-off (nm)	Emission filter (nm)
<b>B Blue</b>	460 - 490	500	520LP
<b>G Green</b>	480 - 550	570	590LP

### Additional filterset (optional)

Name	Excitation filter (nm)	Dichroic mirror cut-off (nm)	Emission filter (nm)
<b>V (Violet)</b>	390 - 420	440	455LP
<b>UV</b>	325 - 375	415	435LP

Part	Description
<b>Observation mode:</b>	Brightfield, HBO fluorescence.
<b>Epi-illumination and filter:</b>	HBO 100 W high pressure mercury lamp. 4-position filter holder; blue & green included.
<b>Head:</b>	Trinocular (2-position 100/0, 0/100), 45° inclined.
<b>Interpupillary distance:</b>	Adjustable between 50 and 75 mm.
<b>Dioptric adjustment:</b>	On the left eyepiece tube.
<b>Eyepieces:</b>	WF10x/22 mm, high eye-point and with rubber cups.
<b>Nosepiece:</b>	Quintuple revolving nosepiece, rotation on ball bearings.
<b>Objectives:</b>	IOS LWD U-PLAN F 10x/0.30 IOS LWD U-PLAN F 20x/0.45 IOS LWD U-PLAN F 40x/0.65 All with anti-fungus treatment.

Part	Description
<b>Specimen stage:</b>	Fixed stage, 250x160 mm, with glass and metal stage inserts.
<b>Focusing:</b>	Coaxial coarse (adjustable tension) and fine focusing mechanism with limit stop to prevent the contact between objective and specimen.
<b>Condenser:</b>	LWD pre-centered condenser, N.A. 0.30, W.D. 72 mm. Removable to extend the working distance up to 150 mm.
<b>Transmitted illumination:</b>	X-LED <sup>8</sup> with white 8 W LED (6,300K) with brightness control. With aperture diaphragm. Multi-plug 100-240Vac/6Vdc external power supply.

# IM-5FLD - LED Fluorescence Microscope

Phase contrast, brightfield and darkfield (dry) LED fluorescence trinocular inverted microscope, with freely configurable lenses according to customer's preferences, FN 24 high eyepoint, infinity corrected optical system, coaxial focusing, mechanical stage, Abbe condenser and powerful, uniform, white color temperature 8 W **X-LED8**. The 4-position epi-fluorescence attachment is powered by extremely powerful 5 W LEDs fluorescence illuminator and combined with blue, green and UV excitation filters for the visualization of the following fluorochromes: Acridine Yellow, Acridine Orange, Auramine, DiO, DTAF, FITC, GFP, YFP (blue filter) plus Rhodamine, Texas Red and TRITC (green filter) plus Alexa Fluor® 350, 7- Amino-4-methylcoumarin, 6-Aminoquinoline, Calcofluor® White, Dansyl cadaverine, DAPI, Dapoxyl, DIDS, Europium (III) Chloride, Fluoro-Gold™, Fura-2, Hoechst 33342 & 33258, 1,5 IAEDANS, Indo-1, Marina Blue®, 4-Methylumbelliferone, PBF1, Pyrene, SBF1, Y66F, Y66H (UV filter) among the others. LED fluorescence ensures unparalleled convenience eliminating warm-up/cool-down times and all the inconveniences related lamp replacement and adjustment. Sturdy and incredibly reliable, it is equipped with all the main controls in ergonomic position and with long lasting, efficient LED illumination to provide over 20 years of use



# IM-5FLD - Specifications



Part	Description
<b>Head:</b>	Trinocular (split ratio: 100/0, 0/100), 45° inclined.
<b>Dioptric adjustment:</b>	Both eyepieces.
<b>Eyepieces:</b>	WF10x/24 mm, high eyepoint and with retractable rubber cups.
<b>Epi-fluorescence illumination &amp; filters:</b>	High-power 5 W LEDs with brightness control, motorized LED selection with centrable field diaphragm, 4-position filter holder; blue (EX 450-490, DM 495, EM 500-550), green (EX 540-580, DM 585, EM 608-682) and UV (EX 340-390, DM 400, EM 420LP) excitation filters included.
<b>Nosepiece:</b>	Quintuple ball bearings revolving nosepiece, reversed.
<b>Objectives:</b>	Selectable according to customer's preferences. All with anti-fungus treatment.
<b>Specimen stage:</b>	Fixed stage, 215x250 mm and attachable mechanical stage, 290x250 mm, 120x80 mm X-Y movement range.
<b>Focusing:</b>	Coaxial coarse and fine focusing mechanism with limit stop to prevent the contact between objective and specimen. Adjustable tension of coarse focusing knob.
<b>Condenser:</b>	Abbe N.A. 0.50, removable, with iris diaphragm and slider for phase contrast.
<b>Transmitted illumination (Full Koehler):</b>	X-LED <sup>®</sup> with white 8 W LED and brightness control. Color temperature: 6,300 K. Multi-plug 100-240Vac/12Vdc external power supply.

## Fluorescence filtersets

Name	Excitation filter (nm)	Dichroic mirror cut-off (nm)	Emission filter (nm)
<b>B (Blue)</b>	450 – 490	495	500 - 550
<b>G (Green)</b>	540 – 580	585	607 - 682
<b>UV (Ultraviolet)</b>	340 -390	400	420LP

### IM-5FLD is freely configurable in terms of objectives, by choosing among:

Included  Optional

Infinity-corrected Plan-Achromatic, Long Working Distance objectives, field flatness up to F.N. 22:		
M-782	IOS LWD W-PLAN objective 4x/0.13	<input type="checkbox"/>
M-773	IOS LWD W-PLAN objective 40x/0.60	<input type="checkbox"/>
M-786	IOS LWD W-PLAN objective 60x/0.70	<input type="checkbox"/>

Infinity-corrected Semi-Apochromatic, Long Working Distance objectives, field flatness up to F.N. 25:		
M-800	IOS LWD U-PLAN F objective 4x/0.13	<input type="checkbox"/>
M-801	IOS LWD U-PLAN F objective 10x/0.30	<input type="checkbox"/>
M-802	IOS LWD U-PLAN F objective 20x/0.45	<input type="checkbox"/>
M-803	IOS LWD U-PLAN F objective 40x/0.65	<input type="checkbox"/>
M-804	IOS LWD U-PLAN F objective 60x/0.75	<input type="checkbox"/>

Positive Phase Contrast Infinity-corrected Plan-Achromatic, Long Working Distance objectives, field flatness up to F.N. 22:		
M-782.1	IOS LWD W-PLAN PH objective 4x/0.13	<input type="checkbox"/>
M-783N	IOS LWD W-PLAN PH objective 10x/0.25	<input type="checkbox"/>
M-784N	IOS LWD W-PLAN PH objective 20x/0.40	<input type="checkbox"/>
M-785	IOS LWD W-PLAN PH objective 40x/0.65	<input type="checkbox"/>

Positive Phase Contrast Infinity-corrected Semi-Apochromatic, Long Working Distance objectives, field flatness up to F.N. 25:		
M-1177	IOS LWD U-PLAN F PH objective 20x/0.45	<input type="checkbox"/>
M-1178	IOS LWD U-PLAN F PH objective 40x/0.65	<input type="checkbox"/>

v 1.4.0 - OPTIKA reserves the right to make corrections, modifications, enhancements, improvements and other changes to its products at any time without notice.

---

## Headquarters and Manufacturing Facilities

---

**OPTIKA® S.r.l.** Via Rigla, 30 - 24010 Ponteranica (BG) - ITALY - Tel.: +39 035.571.392 - [info@optikamicroscopes.com](mailto:info@optikamicroscopes.com)

### Optika Sales branches

---

**OPTIKA® Spain** [spain@optikamicroscopes.com](mailto:spain@optikamicroscopes.com)  
**OPTIKA® China** [china@optikamicroscopes.com](mailto:china@optikamicroscopes.com)  
**OPTIKA® India** [india@optikamicroscopes.com](mailto:india@optikamicroscopes.com)

**OPTIKA® USA** [usa@optikamicroscopes.com](mailto:usa@optikamicroscopes.com)  
**OPTIKA® Central America** [america@optikamicroscopes.com](mailto:america@optikamicroscopes.com)

**OPTIKA<sup>®</sup>**  
M I C R O S C O P E S  
I T A L Y



***INSPECTION & INDUSTRIAL Microscopes***

# INSPECTION & INDUSTRIAL Microscopes

## Professional Stereo Microscopes

**SLX SERIES** - Stereomicroscopes For Higher Education & Laboratory page 263

**SZ SERIES** - Stereozoom Microscopes For Laboratory & Industry page 273

**SZM SERIES** - Stereozoom Microscopes for Routine Inspections page 289

**SZO SERIES** - Stereozoom Microscopes for Laboratory & Industry page 303

**MODULAR SERIES** - Advanced Modular Stereozoom Microscopes page 319

























**GEM SERIES** - Stereozoom Microscopes For Gemology page 343

## Industrial Microscopes

**MET SERIES** - Metallurgical Microscopes page 353

**IS SERIES** - Inspection Video Microscopes page 365

## Icons

	Field number		W-Plan objectives (up to 22mm f.o.v)		USB connection
	Incident light		U-Plan objectives (up to to 24mm f.o.v)		Tablet screen size
	Transmitted light		Fluorescence		Camera resolution
	LED illuminator		Metallography		Software included
	X-LED illuminator		Polarized light		HDMI output
	Multi-Plug low voltage power supply		Darkfield		MicroSD slot
	Infinity corrected optics		Fixed objective		Wi-Fi
	N-Plan objectives (up to 20mm f.o.v)		Zoom objective		BlueTooth

## SLX Series



**Stereomicroscopes For Higher Education & Laboratory**

# Extremely Versatile Cordless Stereo & Stereozoom Microscopes

## PROFESSIONAL FEATURES FOR... WELL, EVERYONE

- » Level up skills and become a professional user
- » 3D Greenough view for high resolved images & large field depth
- » 6.43:1 ratio - 7x ... 45x - or turnable objective - 2x, 4x - on 21 mm
- » Compact, practical and intuitive to use
- » Sturdy and durable for extended lifetime

## THE LONGEST AUTONOMY ON THE MARKET

- » Longlife LED illumination (providing over 20 years of use)
- » Ultra-flat base with  $\varnothing$  100 mm disc for diffused transmitted light
- » Cordless use, totally independent from mains/batteries connection
- » Freely settable illumination - incident, oblique and transmitted light
- » External power supply for enhanced safety and convenient servicing

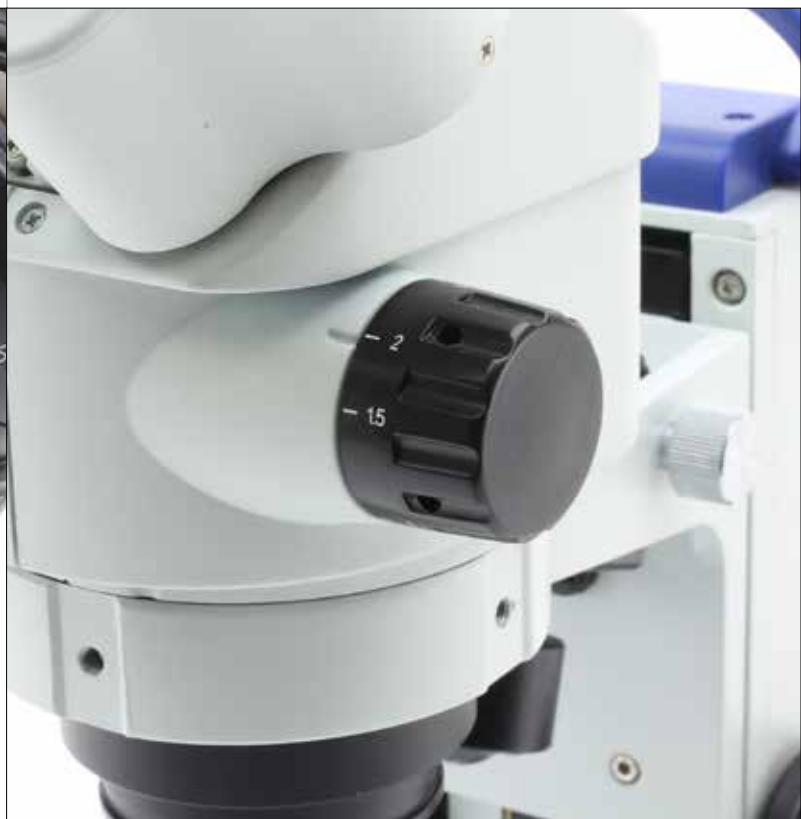



# SLX Series

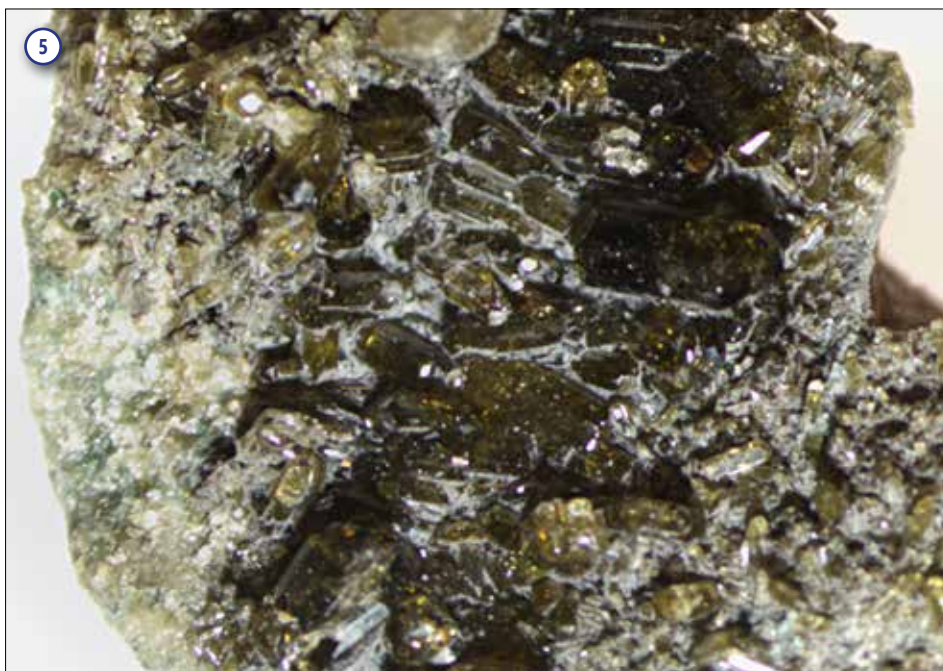
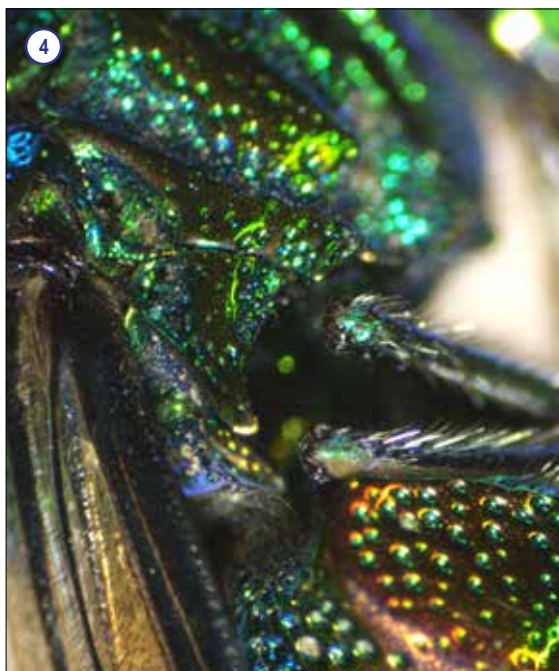
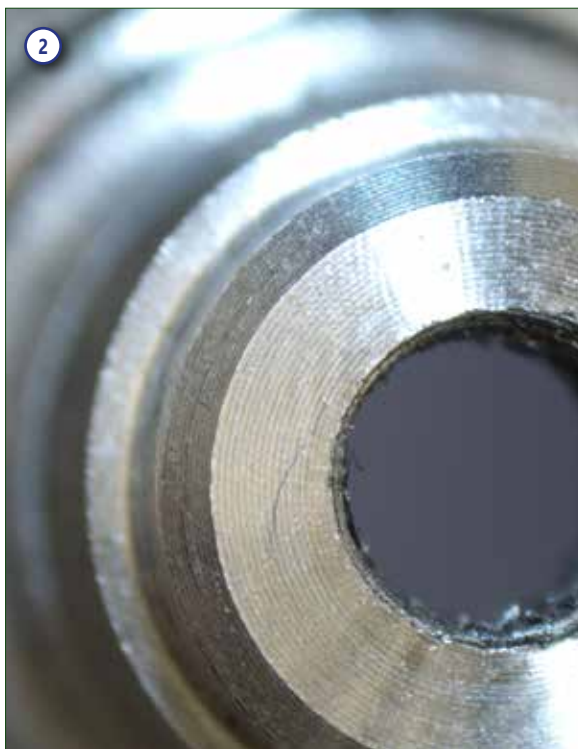

## Legend

- |   |                                       |
|---|---------------------------------------|
| 1. Aluminum - SLX-1 and 4x objective.             | 4. Fly, detail - SLX-2 and 4.5x zoom. |
| 2. Component worked on lathe - SLX-2 and 3x zoom. | 5. Rock - SLX-2 - 1.5x zoom.          |
| 3. Wasp - SLX-3 and 4x zoom.                      |                                       |

## SLX Series



Valuable configurations of cordless and modern stereo & stereozoom microscopes ideal for a variety of applications, including dissection, biology, entomology, anatomy, chemistry, material science among the others and even industrial purposes.

Provided with dual magnification or **6.43:1 zoom ratio**, **FN 21** high eyepoint eyepieces, high-grade precise fixed arm with focus and handle with the latest technology of **EcoLED™** illumination plus rechargeable batteries. Slim and easy to carry, all the models with high-grade precise fixed arm are equipped with long lasting **LED** illumination to provide over 20 years of use.

### High eyepoint eyepieces for glasses wearers

These eyepieces are designed in such a way that the exit pupil is further away from the eye lens than standard eyepieces, being well suited for eyeglasses wearers

### The longest autonomy on the market ensured by EcoLED™

OPTIKA has re-designed illumination in microscopy, once again: a special coating process on optics combined with a new, higher ratio between low consumptions and ultra-efficiency has addressed us to top brightness levels

### 6.43:1 zoom ratio - zoom magnification from 7x to 45x

Purposely designed for professional routine inspections, the total magnification can be even extended to 135x with 20x eyepieces and 1.5x additional lens, obtaining an excellent results in this class



### Ultra-flat base with Ø 100 mm disc for diffused transmitted light

A new level of ergonomics and comfort is achieved during operations, with the ultra-flat base of only 3 cm height to ensure smooth specimen movement and the Ø 100 mm for top class diffusion of the transmitted light

# Stereomicroscopes For Higher Education & Laboratory

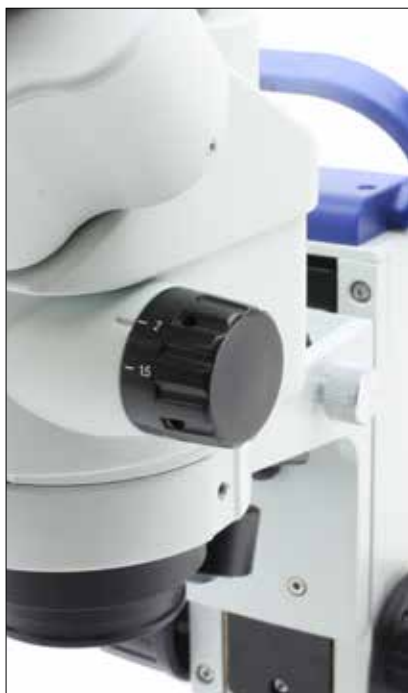

### Longlife LED illumination (providing over 20 years of use)

Money & energy saving thanks to LED long lifetime (65.000 hours, 22 years in case of 8 hours/day) which is more than 20 times compared to a standard halogen bulb

### Cordless use, totally independent from mains/batteries connection

All models work with or without the batteries in place and are provided with three NiMH rechargeable batteries for the longest autonomy in outdoor use (12-hour autonomy, at medium intensity)



### External power supply for enhanced safety and convenient servicing

OPTIKA's safety first approach drives to the use of a low voltage, multi-plug, external power supply in order to prevent any risk of electric shock and heatflow inside the unit

## SLX Series - Get the most out of our accessories

### Additional Lenses

Simply to be screwed into the threads below the objectives of SLX-2 and SLX-3 to either increase or decrease total magnification, or to increase the working distance when users need to work with hands under the microscope



ST-091 - Additional lens 0.75x

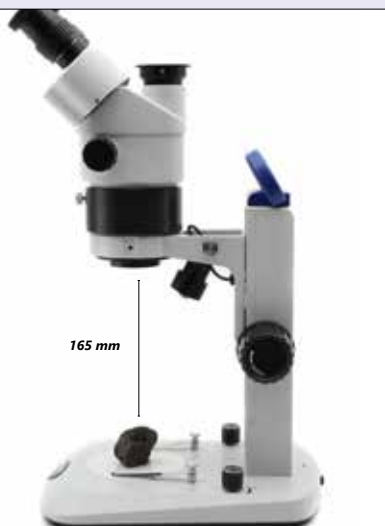

ST-085.1 - Additional lens 0.5x (w.d. 165mm) with SZ-EXT

### ST-040.1 - Darkfield condenser

This is a darkfield condenser for stereo microscopes with bottom light and 100 mm round working plate to provide dark-field microscopy features, fitting all OPTIKA stereomicroscopes with 100 mm mounting size and transmitted light

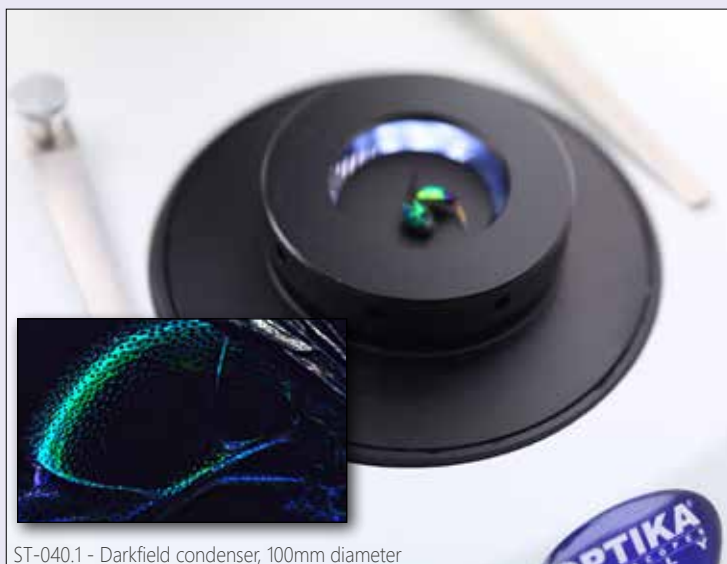

ST-040.1 - Darkfield condenser, 100mm diameter

# SLX Series - Range

## SLX-1

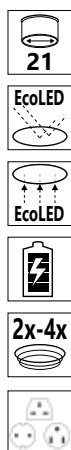

Cordless binocular stereomicroscope ideal for students, schools and amateurs to dissect and discover mainly biology and materials science in 3D, with turnable objective (2x-4x), FN 21 high eyepoint, precision fixed arm with handle and the latest technology of EcoLED™ illumination plus rechargeable batteries. Slim and easy to carry, it is equipped with long lasting LED illumination to provide over 20 years of use.

**Head:** Binocular, 45° inclined; 360° rotating.

**Dioptric adjustment:** Left eyepiece.

**Eyepieces:** WF10x/21 mm, high eyepoint, secured by screw and with rubber cups.

**Objective:** Achromatic 2x-4x with anti-fungus treatment.

**Working distance:** 100 mm.

**Stand:** High-grade, precision fixed with handle and focus.

**Focusing:** Rack and pinion focusing mechanism.

**Illumination:** EcoLED™ swiveling incident and transmitted, with brightness control, rechargeable batteries.

Color temperature: 6,300 K.

Multi-plug 100-240Vac/5Vdc external power supply.

## SLX-2

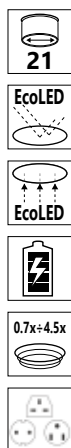

Cordless binocular stereozoom microscope ideal for students, schools and amateurs to dissect and discover mainly biology and materials science in 3D, with 0.7x...4.5x zoom, FN 21 high eyepoint, precision fixed arm with handle and the latest technology of EcoLED™ illumination plus rechargeable batteries. Slim and easy to carry, it is equipped with long lasting LED illumination to provide over 20 years of use.

**Head:** Binocular, 45° inclined; 360° rotating.

**Dioptric adjustment:** Both eyepieces.

**Eyepieces:** WF10x/21 mm, high eyepoint, secured by screw and with rubber cups.

**Objective:** Parfocal achromatic zoom 0.7x...4.5x (6.43:1 ratio) with anti-fungus treatment.

**Working distance:** 100 mm.

**Stand:** High-grade, precision fixed with handle and focus.

**Focusing:** Rack and pinion focusing mechanism.

**Illumination:** EcoLED™ swiveling incident and transmitted, with brightness control, rechargeable batteries.

Color temperature: 6,300 K.

Multi-plug 100-240Vac/5Vdc external power supply.

# SLX Series - Range

## SLX-3

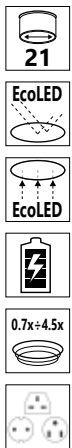

Cordless trinocular stereozoom microscope ideal for students, schools and amateurs to dissect and discover mainly biology and materials science in 3D, with 0.7x...4.5x zoom, FN 21 high eyepoint, precision fixed arm with handle and the latest technology of EcoLED™ illumination plus rechargeable batteries. Slim and easy to carry, it is equipped with long lasting LED illumination to provide over 20 years of use.

**Head:** Trinocular (split ratio: 50/50), 45° inclined; 360° rotating.

**Dioptric adjustment:** Both eyepieces.

**Eyepieces:** WF10x/21 mm, high eyepoint, secured by screw and with rubber cups.

**Objective:** Parfocal achromatic zoom 0.7x...4.5x (6.43:1 ratio) with anti-fungus treatment.

**Working distance:** 100 mm

**Stand:** High-grade, precision fixed with handle and focus.







**Focusing:** Rack and pinion focusing mechanism.

**Illumination:** EcoLED™ swiveling incident and transmitted, with brightness control, rechargeable batteries. Color temperature: 6,300 K. Multi-plug 100-240Vac/5Vdc external power supply.



# SLX Series - Range

## SLX-4 / SLX-5

-  21
-  EcoLED
-  EcoLED
- 
-  0.7x-4.5x
- 



**SLX-5**

Binocular (SLX-4) or trinocular (SLX-5) stereomicroscope with Extremely stable, long overhanging stand for observation of particularly large specimens to be matched with a focusing system and stereozoom head. Smooth horizontal and vertical movements are ensured and the head can be easily swivelled for inspection at oblique angles. In case illumination is needed, choose from the wide choice of external illuminators available.

**Head:**

**SLX-4:** Binocular, 45° inclined; 360° rotating.

**SLX-5:** Trinocular (split ratio: 50/50), 45° inclined; 360° rotating.

**Dioptric adjustment:** Both eyepieces.

**Eyepieces:** WF10x/21 mm, high eyepoint, secured by screw and with rubber cups.

**Objective:** Parfocal achromatic zoom 0.7x...4.5x (6.43:1 ratio) with anti-fungus treatment.

**Working distance:** 100 mm.

**Focusing:** Rack and pinion mechanism controlled by a pair of knobs placed on both sides of the stand.

**Stand:** Overhanging stand 420 mm high, 430 mm horizontal arm length, base 230x230 mm with following adjustments: height, longitudinal extension and head rotation angle (left-right).

# SLX Series - Comparison Chart

Model	Head	Eyepieces	Objective	Working Distance	Stand	Illumination
<b>SLX-1</b>	Binocular 45° inclined 360° rotating	WF 10x/21	2x – 4x selectable	100 mm	High-grade, precision fixed with handle and focus	<b>EcoLED™</b> swiveling incident and transmitted with brightness control, rechargeable batteries
<b>SLX-2</b>	Binocular 45° inclined 360° rotating	WF 10x/21	0.7x...4.5x zoom	100 mm	High-grade, precision fixed with handle and focus	<b>EcoLED™</b> swiveling incident and transmitted with brightness control, rechargeable batteries
<b>SLX-3</b>	Trinocular (50/50) 45° inclined 360° rotating	WF 10x/21	0.7x...4.5x zoom	100 mm	High-grade, precision fixed with handle and focus	<b>EcoLED™</b> swiveling incident and transmitted with brightness control, rechargeable batteries
<b>SLX-4</b>	Binocular 45° inclined 360° rotating	WF 10x/21	0.7x...4.5x zoom	100 mm	Overhanging stand	Without illumination; External light source needed
<b>SLX-5</b>	Trinocular (50/50) 45° inclined 360° rotating	WF 10x/21	0.7x...4.5x zoom	100 mm	Overhanging stand	Without illumination; External light source needed

## Optical performance SLX-1

Eyepiece	10x (ST-081)		15x (ST-082)		20x (ST-083)		10x (ST-084)	
Field number (mm)	21		15		10		21	
Additional lens	Total magnification	Field of View (mm)	Total magnification	Field of View (mm)	Total magnification	Field of View (mm)	Total magnification	Field of View (mm)
1x	20x - 40x	10.50 - 5.25	30x - 60x	7.50 - 3.75	40x - 80x	5.00 - 2.50	20x - 40x	10.50 - 5.25

## Optical performance SLX-2 - SLX-3 - SLX-4 - SLX-5

Eyepiece	10x (ST-081)		15x (ST-082)		20x (ST-083)		10x (ST-084)	
Field number (mm)	21		15		10		21	
Additional lens	Total magnification	Field of View (mm)	Total magnification	Field of View (mm)	Total magnification	Field of View (mm)	Total magnification	Field of View (mm)
0.5x	3.5x - 22.5x	60.00 - 9.33	5.25x - 33.75x	42.86 - 6.67	7x - 45x	28.57 - 4.44	3.5x - 22.5x	60.00 - 9.33
0.75x	5.25x - 33.75x	40.00 - 6.22	7.875x - 50.625x	28.57 - 4.44	10.5x - 67.5x	19.05 - 2.96	5.25x - 33.75x	40.00 - 6.22
1x	7x - 45x	30.00 - 4.67	10.5x - 67.5x	21.43 - 3.33	14x - 90x	14.29 - 2.22	7x - 45x	30.00 - 4.67
1.5x	10.5x - 67.5x	20.00 - 3.11	15.75x - 101.25x	14.29 - 2.22	21x - 135x	9.52 - 1.48	10.5x - 67.5x	20.00 - 3.11



# SLX Series - Accessories

## Eyecups & Eyepieces

ST-036	Eyecups (pair), curved
ST-081	EW10x/21 eyepieces (pair), high eyepoint, with rubber cup
ST-082	WF15x/15 eyepieces (pair), high eyepoint
ST-083	WF20x/10 eyepieces (pair), high eyepoint
ST-084	WF10x/21 micrometric eyepiece, high eyepoint, with rubber cup

## Objectives & Additional Lenses

ST-085.1	Additional lens 0.5x (w.d. 165mm) with SZ-EXT (except for SLX-1)
ST-091	Additional lens 0.75x (w.d. 105mm) (except for SLX-1)
ST-086.1	Additional lens 1.5x (w.d. 45mm) with compensating disc (except for SLX-1)
ST-087	Additional lens 2x (w.d. 33mm) (only for SLX-4 & SLX-5)

## Stages

ST-100.1	Hand moving stage, 100mm diameter
ST-110.1	Moving stage, coaxial knobs, 100mm diameter
ST-111.1	Moving stage, micrometric screws, 100mm diameter
ST-666.1-EU	Applicable heating stage (stereomicroscopes, 100mm diameter), EU
ST-666.1-UK	Applicable heating stage (stereomicroscopes, 100mm diameter), UK
ST-666.1-US	Applicable heating stage (stereomicroscopes, 100mm diameter), US
ST-666.1-SW	Applicable heating stage (stereomicroscopes, 100mm diameter), CH

## Condensers & Filters

ST-040.1	Darkfield condenser, 100mm diameter
ST-088.1	Polarising set (filters and rotating stage), 100mm diameter

## Camera Adapters

M-113.1	Ring adapter, 30mm (for monocular and binocular microscopes)
M-115	0.35x C-Mount projection lens
M-114	0.5x C-Mount projection lens
M-118	0.75x C-Mount projection lens
M-173	C-Mount projection lens for APS-C/full frame reflex cameras (trino)
M-699	Universal adapter for C-Mount projection lens (trino)
ST-090	0.35x focusable C-Mount adapter (stereomicroscopes)
ST-090.1	0.5x focusable C-Mount adapter (stereomicroscopes)
ST-090.2	0.65x focusable C-Mount adapter (stereomicroscopes)
M-620.3	1x focusable C-Mount adapter (biological & stereomicroscopes)

## Miscellaneous

15104	Cleaning kit
DC-002	Plastic dust cover, medium, 490(l)x490(h) mm (only for SLX-1, SLX-2 and SLX-3)
DC-004	TNT dust cover, large, 700(l)x550(h) mm (only for SLX-4 & SLX-5)
M-005	Micrometric slide, 26x76mm, with 2 scales (1mm/100 & 10mm/100)
ST-041	Sample clip
ST-042	White/black object-plate, 100mm diameter
ST-043	Glass object-plate, 100mm diameter
ST-092	Protective glass for stereohead
VP-SLX	IQ/OQ/PQ manual for SLX series



### How to connect the cameras to our microscopes.

Please refer to the Adapter reference list on Digital section.

### 15104 - Cleaning kit

It cleans glass quickly and effectively, without leaving residue or odor. Ideal for precision lens or prism cleaning.



v 1.4.0 - OPTIKA reserves the right to make corrections, modifications, enhancements, improvements and other changes to its products at any time without notice.

## Headquarters and Manufacturing Facilities

**OPTIKA® S.r.l.** Via Rigla, 30 - 24010 Ponteranica (BG) - ITALY - Tel.: +39 035.571.392 - info@optikamicroscopes.com

## Optika Sales branches

**OPTIKA® Spain** spain@optikamicroscopes.com  
**OPTIKA® China** china@optikamicroscopes.com  
**OPTIKA® India** india@optikamicroscopes.com

**OPTIKA® USA** usa@optikamicroscopes.com  
**OPTIKA® Central America** america@optikamicroscopes.com



# SZ Series



**Stereozoom Microscopes For Laboratory & Industry**

# FIELD OF VIEW - 23 mm Full Plan Field of View

## 10x/22mm or 10x/23mm PLAN EYEPIECES

Plan eyepieces with 22 or 23 mm field of view; high eye-point type, also suitable for the use of eyeglasses.

## ZOOM OBJECTIVE

The High-Grade Zoom Objective grants a sharp and clear vision. With a zoom ratio of 6.72:1 or 8.46:1 it makes this series a perfect instrument for any application.



## CLICK-STOP DETENTS

On SZO Heads the zoom objective is equipped with a precise click-stop mechanism which makes easy to quickly find the default zoom positions: 0.67x, 0.80x, 1x, 1.2x, 1.5x, 2x, 2.5x, 3x, 3.5x, 4x, and 4.5x.



# X-LED - Two Times Brighter Than Any Other



## X-LED: A SEA OF LIGHT

Where present, stands' illuminators are equipped with X-LED systems:

- the incident illuminator with **X-LED<sup>3</sup>** (single LED, 3.6W)
- the transmitted illuminator with **X-LED<sup>T1-T3</sup>** (12 or 60 LEDs)

## X-LED: RESPECTING COLORS

With 6,300K color temperature the samples are illuminated with the most natural light. It allows to respect their colors, without altering the nuances.



## X-LED<sup>T3</sup>: SIMPLY UNMATCHABLE

Top class illuminator for transmitted light. With up to 60 LEDs geometrically arranged, it grants a perfect light uniformity and the observation of large samples thanks to its 10cm diameter.



Multi-plug power supply

## SZ Series

### Greenough Optical System

The V-shape optical path of Greenough allows us to design a very compact and a slim unit, highly versatile and appreciated for the 3D viewing. Samples with significant depth can be quickly inspected. Binocular and trinocular heads are 45° inclined to grant comfortable posture to the user even after several hours of operation.

### Zoom Ratio

SZ Series has 0.67x-4.5x or 0.65x-5.5x zoom range (6.72:1 or 8.46:1 zoom ratio, depending on the head), being purposely designed for routine and advanced inspections. These zoom ratios enable most samples to be observed at the appropriate magnifications. When combined with proper accessories (2x additional lens and 25x eyepieces), SZX-A delivers excellent image quality up to 275x.



### X-LED Exclusive Lighting Source

Special technology able to double the light intensity for incomparable performance, ensuring constant pure-white colour temperature.

Relevant money & energy saving thanks to the incredibly low energy consumptions allow you to cut the electricity bills by 90%!

# Stereozoom Microscopes For Laboratory & Industry

## Overhanging Stands, In Case Of Large Samples

These stands are recommended for efficient, quick and precise observation and digital imaging of large samples, that cannot be processed with regular stands.

Achieve 360° rotation and smooth movement with no limits, as the mechanism can be tilted from right to left, backward to forward.

## Large Working Distance And Field Of View Size Are Important!

If you need to work under the microscope, you will need a large working distance.

SZ series ensures an extended working distance of 110mm. Keep in my mind your application, always: if you are soldering a printed circuit board, it may be more important to have a long working distance; if you are counting items, then a large field of view will be of great assistance.

**LWD  
110mm**



## Get the most out of our accessories

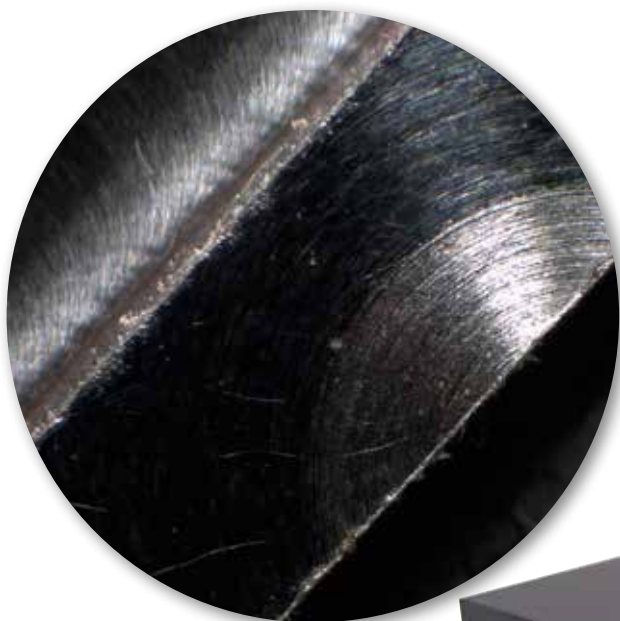

### ST-111 - Moving stage

Moving stage ST-111 is a micrometer positioning stage with XY graduation of 0.01mm.

Whenever you need to precisely move the sample or make measurements, this is the ideal solution. It works with both incident and transmitted illumination, and it is equipped with rotating stage and sample clips. It is suggested to use it in conjunction with the optional micrometer eyepieces.



# SZ Series - Modular Chart

**SZX-B**  
WF 10x/22  
0.67x...4.5x



**SZX-T**  
WF 10x/22  
0.67x...4.5x



**SZX-BA**  
WF 10X/23  
0.65x...5.5x



**SZ-A1**  
Coarse focus



**SZ-A6**  
Coarse & Fine focus



**SZ-ST1**  
Simple Stand



**SZ-ST2**  
Stand with Incident (X-LED<sup>3</sup>) and Transmitted (12-Led) Illuminators



**SZ-ST3**  
Stand with Incident (X-LED<sup>3</sup>) and Transmitted (60-Led) Illuminators



**SZ-ST7**  
Stand with **Double Incident** (X-LED<sup>3</sup>) and Transmitted (12-Led) Illuminators



**SZ-ST8**  
Stand with **Double Incident** (X-LED<sup>3</sup>) and Transmitted (60-Led) Illuminators



# SZ Series - Modular Chart

**SZX-TA**  
WF 10X/23  
0.65x - 5.5x



**SZO-B**  
WF 10X/23  
0.67x...4.5x Click-stops



**SZO-T**  
WF 10X/23  
0.67x...4.5x Click-stops



**SZ-STLX**

Advanced Precision Overhanging Stand with Coarse Focus Mechanism



**SZ-STL1**

Overhanging Stand



**SZ-STL2**

Advanced Overhanging Stand



# SZ Series - Heads

## SZX-B / SZX-T



### SZX Heads - Excellent Price/Performance Ratio For Any Laboratory

- » Ideal for universities, experts & common routine lab requirements
- » 3D Greenough view for high resolved images & large field depth
- » 22 mm field number and large working distance (up 110 mm)
- » 6.72:1 zoom ratio - zoom magnification from 6.7x to 45x
- » Simultaneous eyepiece & camera observation (on SZX-T)
- » Cost-effective solution for diversified applications

#### Head:

**SZX-B:** Binocular, 360° rotating on all stands and 45° inclined.

**SZX-T:** Trinocular (split ratio: 50/50), 360° rotating on all stands and 45° inclined.

**Interpupillary distance:** Adjustable between 51 and 75 mm.

**Dioptric adjustment:** On both eyepieces.

**Eyepieces:** WF10x/22 mm, high eyepoint, secured by screw and with integrated rubber cups.

**Objective:** Parfocal achromatic zoom 0.67x...4.5x (zoom factor 6.72:1)

**Working distance:** 110 mm.

## SZX-BA / SZX-TA



### SZX-A Heads - Advanced Analysis With High Power Magnification

- » Purposely designed for particularly performing zoom conditions
- » 3D Greenough view for high resolved images & large field depth
- » 23 mm field number and large working distance (up 110 mm)
- » 8.46:1 zoom ratio - zoom magnification from 6.5x to 55x
- » Simultaneous eyepiece & camera observation (on SZX-TA)
- » High magnification change from overview to tiny details

#### Head:

**SZX-BA:** Binocular, 360° rotating on all stands and 45° inclined.

**SZX-TA:** Trinocular (split ratio: 50/50), 360° rotating on all stands and 45° inclined.

**Interpupillary distance:** Adjustable between 51 and 75 mm.

**Dioptric adjustment:** On both eyepieces.

**Eyepieces:** WF10x/23 mm, high eyepoint, secured by screw and with integrated rubber cups.

**Objective:** Parfocal achromatic zoom 0.65x...5.5x (zoom factor 8.46:1).

**Working distance:** 110 mm.



# SZ Series - Heads

## SZO-B / SZO-T



### SZO Heads - Addressed For Extreme Reliability & Repeatability

- » Ensuring the sharpest vision, high productivity, repetitive analysis
- » 3D Greenough view for high resolved images & large field depth
- » 23 mm field number and large working distance (up 110 mm)
- » 6.72:1 zoom ratio - zoom magnification from 6.7x to 45x
- » Simultaneous eyepiece & camera observation (on SZO-T)
- » Multi-position click-stop - no need to move eyes from eyepieces

#### Head:

**SZO-B:** Binocular, 360° rotating on all stands and 45° inclined.

**SZO-T:** Trinocular (split ratio: 70/30), 360° rotating on all stands and 45° inclined.

**Interpupillary distance:** Adjustable between 51 and 75 mm.

**Dioptric adjustment:** On both eyepieces.

**Eyepieces:** WF10x/23 mm, high eyepoint, secured by screw and with retractable rubber cups.

**Objective:** Parfocal achromatic zoom 0.67x...4.5x (zoom factor 6.72:1) with click-stop.

**Working distance:** 110 mm.

### CLICK-STOP DETENTS

On SZO Heads the zoom objective is equipped with a precise click-stop mechanism which makes easy to quickly find the default zoom positions: 0.67x, 0.80x, 1x, 1.2x, 1.5x, 2x, 2.5x, 3x, 3.5x, 4x, and 4.5x.

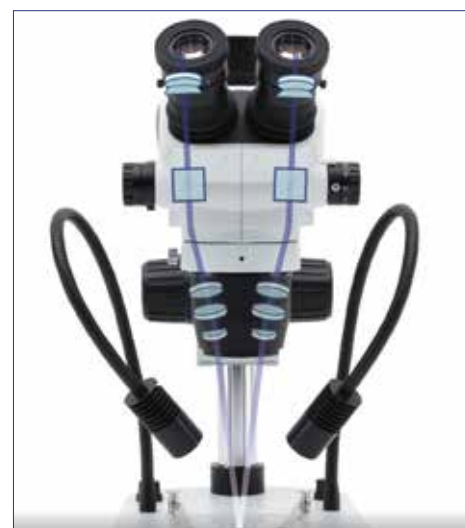

## SZ Series - Zoom Heads Comparison Chart

Model	Head	Eyepieces	Zoom Objective	Zoom Ratio	Click-Stops Detents	Working Distance	Photo Tube
<b>SZX-B</b>	Binocular 45° inclined	WF 10x/22	0.67x...4.5x	6.72:1	-	110 mm	-
<b>SZX-T</b>	Trinocular 45° inclined	WF 10x/22	0.67x...4.5x	6.72:1	-	110 mm	Fixed 50%-50%
<b>SZX-BA</b>	Binocular 45° inclined	WF 10x/23	0.65x...5.5x	8.46:1	-	110 mm	-
<b>SZX-TA</b>	Trinocular 45° inclined	WF 10x/23	0.65x...5.5x	8.46:1	-	110 mm	Fixed 50%-50%
<b>SZO-B</b>	Binocular 45° inclined	WF 10x/23	0.67x...4.5x	6.72:1	0.67x, 0.80x, 1x, 1.2x, 1.5x, 2x, 2.5x, 3x, 3.5x, 4x, and 4.5x	110 mm	-
<b>SZO-T</b>	Trinocular 45° inclined	WF 10x/23	0.67x...4.5x	6.72:1	0.67x, 0.80x, 1x, 1.2x, 1.5x, 2x, 2.5x, 3x, 3.5x, 4x, and 4.5x	110 mm	Fixed 70%-30%

# SZ Series - Pillar Stands

## SZ-ST1



Extremely stable, ultra-slim and modern stand to be matched with a focusing system and stereozoom head. The 25 mm height makes this stand very effective in preventing fatigue during operation, increasing the ergonomics and the performance as a result. In case illumination is needed, choose from the wide choice of external illuminators available.

<b>Width:</b> 210 mm
<b>Length:</b> 270 mm
<b>Thickness:</b> 25 mm
<b>Pillar diameter:</b> 32 mm
<b>Pillar height:</b> 275 mm
<b>Stage:</b> 95 mm dia., black and white disc with sample clips
<b>Incident illumination:</b> None
<b>Transmitted illumination:</b> None

To be used in combination with a focusing mechanism (SZ-A1/A6)

## SZ-ST2 / SZ-ST3

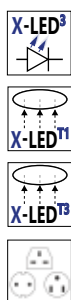

**Top-class X-LED<sup>™</sup> transmitted light, with geometrically arranged LEDs and X-LED<sup>3</sup> incident light**  
 The impressive incident illumination generated by the exclusive X-LED<sup>3</sup> swivelling illuminator (3.6 W) is combined with an extra-large, settable 12-LED X-LED<sup>™</sup> disc (2 W, on SZ-ST2) or 60-LED X-LED<sup>™3</sup> disc (4 W, on SZ-ST3) for transmitted illumination.

**Incident illumination:** X-LED<sup>3</sup> with white 3.6 W LED and brightness control. Color temperature: 6,300 K.

**Transmitted illumination:**  
**SZ-ST2:** 12-LED X-LED<sup>™</sup> disc with white 2 W LED and brightness control. Color temperature: 6,300 K. Multi-plug 100-240Vac/6Vdc external power supply.  
**SZ-ST3:** 60-LED X-LED<sup>™3</sup> disc with white 4 W LED and brightness control. Color temperature: 6,300 K. Multi-plug 100-240Vac/12Vdc external power supply.

**Base dimensions:** 270×210 mm.

**Pillar dimensions:** Ø32×280 mm.

**Weight:** 1.90 kg.

To be used in combination with a focusing mechanism (SZ-A1/A6)



**SZ-ST2:** 12-Led X-LED<sup>™</sup> Transmitted Illuminator



**SZ-ST3:** 60-Led X-LED<sup>™3</sup> Transmitted Illuminator

# SZ Series - Pillar Stands

## SZ-ST7 / SZ-ST8



**Top-class X-LED<sup>™</sup> transmitted light, with geometrically arranged LEDs and freely orientable, flexible double gooseneck X-LED<sup>™</sup> incident light**

The impressive incident illumination generated by the exclusive X-LED<sup>™</sup> lighting system located in two flexible gooseneck arms (3.6 W each, for a total of 7.2 W) is combined with an extra-large, settable 12-LED X-LED<sup>™</sup> disc (2 W, on SZ-ST7) or 60-LED X-LED<sup>™</sup> disc (4 W, on SZ-ST8) for transmitted illumination.

**Incident illumination:** Two flexible X-LED<sup>™</sup> gooseneck arms with white 3.6 W LED/each and brightness control. Illuminance: 170,000 lux (at 10 cm distance). Color temperature: 6,300 K.

**Transmitted illumination:**

**SZ-ST7:** 12-LED X-LED<sup>™</sup> disc with white 2 W LED and brightness control. Illuminance: 4,000 lux. Color temperature: 6,300 K. Multi-plug 100-240Vac/12Vdc external power supply.

**SZ-ST8:** 60-LED X-LED<sup>™</sup> disc with white 4 W LED and brightness control. Illuminance: 8,000 lux. Color temperature: 6,300 K. Multi-plug 100-240Vac/12Vdc external power supply.

**Base dimensions:** 270×210 mm.

**Pillar dimensions:** Ø32×280 mm.

**Weight:** 2.40 kg.

To be used in combination with a focusing mechanism (SZ-A1/A6)



**SZ-ST7:** 12-Led X-LED<sup>™</sup> Transmitted Illuminator



**SZ-ST8:** 60-Led X-LED<sup>™</sup> Transmitted Illuminator

# SZ Series - Pillar Stands Comparison Chart

Model	Base	Pillar	Stage	Incident Illumination	Transmitted Illumination
<b>SZ-ST1</b>	270x210x25h mm	32dia.x275h mm	95 mm dia., black and white disc with sample clips	None	None
<b>SZ-ST2</b>	270x210x30h mm	32dia.x280h mm	95 mm dia., white disc with sample clips	X-LED <sup>™</sup> (single Led, 3.6 W); brightness control	X-LED <sup>™</sup> (12-Led); brightness control
<b>SZ-ST3</b>	270x210x30h mm	32dia.x280h mm	95 mm dia., white disc with sample clips	X-LED <sup>™</sup> (single Led, 3.6 W); brightness control	X-LED <sup>™</sup> (60-Led); brightness control
<b>SZ-ST7</b>	270x210x30h mm	32dia.x280h mm	95 mm dia., white disc with sample clips	Double X-LED <sup>™</sup> (total 7.2 W) on flexible goosenecks; brightness control	X-LED <sup>™</sup> (12-Led); brightness control
<b>SZ-ST8</b>	270x210x30h mm	32dia.x280h mm	95 mm dia., white disc with sample clips	Double X-LED <sup>™</sup> (total 7.2 W) on flexible goosenecks; brightness control	X-LED <sup>™</sup> (60-Led); brightness control

# SZ Series - Boom Stands

## SZ-STLX



Extremely stable, long overhanging stand complete of head holder and coarse focusing system for observation of particularly large specimens to be matched with a stereozoom head. Smooth horizontal and vertical movements are ensured and the head can be easily swivelled and tilted for inspection at oblique angles. In case illumination is needed, choose from the wide choice of external illuminators available.

<b>Base dimensions:</b>	: 210×255 mm
<b>Pillar dimensions:</b>	∅32×430 mm
<b>Horizontal arm:</b>	790 mm
<b>Maximum sample height:</b>	270 mm
<b>Swivelling movement:</b>	360°
<b>Tilting movement:</b>	180°
<b>Weight:</b>	16.3 kg

## SZ-STL1



Extremely stable, long overhanging stand for observation of particularly large specimens to be matched with a focusing system and stereozoom head. Smooth horizontal and vertical movements are ensured and the head can be easily swivelled for inspection at oblique angles. In case illumination is needed, choose from the wide choice of external illuminators available.

<b>Base dimensions:</b>	230×230 mm
<b>Pillar dimensions:</b>	∅32×435 mm.
<b>Horizontal arm:</b>	415 mm
<b>Maximum sample height:</b>	400 mm
<b>Swivelling movement:</b>	360°
<b>Weight:</b>	14.00 kg

To be used in combination with a focusing mechanism (SZ-A1 or SZ-A6)

## SZ-STL2



Extremely stable, hinged and long overhanging stand for observation of particularly large specimens to be matched with a focusing system and stereozoom head. Smooth horizontal and vertical movements are ensured and the head can be easily swivelled and tilted for inspection at oblique angles. In case illumination is needed, choose from the wide choice of external illuminators available.

<b>Base dimensions:</b>	260×210 mm
<b>Pillar dimensions:</b>	∅32×425 mm
<b>Horizontal arm:</b>	515 mm
<b>Maximum sample height:</b>	440 mm
<b>Swivelling movement:</b>	360°
<b>Tilting movement:</b>	180°
<b>Weight:</b>	18.8 kg

To be used in combination with a focusing mechanism (SZ-A1 or SZ-A6)

# SZ Series - Focusing Mechanisms

## SZ-A1



**Entry-level coarse focusing to raise or lower the head to focus**  
Coarse focusing system (76 mm head holder, 32 mm pillar) with adjustable tension for standard stereomicroscope requirements.

**Type:** Coarse

**Coarse total travel:** 50 mm

**Adjustable tension:** Yes

**Head holder internal diameter:** 76 mm

**Pillar diameter:** 32 mm

## SZ-A6



**Coaxial coarse and fine focusing results in easy, precise conditions**

Coaxial coarse and fine focusing system (76 mm head holder, 32 mm pillar) with 2  $\mu$ m fine resolution and adjustable tension ideal for extremely precise fine adjustments and smooth movements.

**Type:** Coaxial coarse and fine

**Coarse total travel:** 50 mm

**Fine total travel (per single rotation):** 0.2 mm.

**Fine graduations:** 100

**Fine resolution:** 2  $\mu$ m

**Adjustable tension:** Yes

**Head holder internal diameter:** 76 mm

**Pillar diameter:** 32 mm



# SZ Series - Optical Performance

## SZX-B and SZX-T Heads

Eyepiece	10x (ST-141)		15x (ST-302)		20x (ST-303)		25x (ST-144)	
Field number (mm)	22		16		12		9	
Objective	Total magnification	Field of View (mm)	Total magnification	Field of View (mm)	Total magnification	Field of View (mm)	Total magnification	Field of View (mm)
0.3x (W.D: 287 mm)	2.01x-13.5x	109.45-16.30	3.02x-20.25x	79.60-11.85	4.02x-27x	59.70-8.89	5.02x-33.75x	44.78-6.67
0.5x (W.D: 177 mm)	3.35x-22.5x	65.67-9.78	5.02x-33.75x	47.76-7.11	6.7x-45x	35.82-5.33	8.37x-56.25x	26.87-4.0
0.75x (W.D: 120 mm)	5.02x-33.75x	43.78-6.52	7.54x-50.62x	31.84-4.74	10.05x-67.5x	23.88-3.56	12.56x-84.37x	17.91-2.67
1x (W.D: 110 mm)	6.7x-45x	32.84-4.89	10.05x-67.5x	23.88-3.56	13.4x-90x	17.91-2.67	16.75x-112.5x	13.43-2.0
1.5x (W.D: 47 mm)	10.05x-67.5x	21.89-3.26	15.07x-101.25	15.92-2.37	20.1x-135x	11.94-1.78	25.12x-168.75x	8.96-1.33
2x (W.D: 26 mm)	13.4x-90.0x	16.42-2.44	20.1x-135x	11.94-1.78	26.8x-180x	8.96-1.33	33.5x-225x	6.72-1.0

## SZX-BA and SZX-TA Heads

Eyepiece	10x (ST-306)		15x (ST-302)		20x (ST-303)		25x (ST-144)	
Field number (mm)	23		16		12		9	
Objective	Total magnification	Field of View (mm)	Total magnification	Field of View (mm)	Total magnification	Field of View (mm)	Total magnification	Field of View (mm)
0.3x (W.D: 287 mm)	1.95x-15.5x	117.95-13.94	2.93x-23.25x	82.05-9.70	3.9x-31.0x	61.54-7.27	4.88x-38.75x	46.15-5.45
0.5x (W.D: 177 mm)	3.25x-27.5x	70.77-8.36	4.88x-41.25x	49.23-5.82	6.5x-55x	36.92-4.36	8.13x-68.75x	27.69-3.27
0.75x (W.D: 120 mm)	4.87x-41.25x	47.18-5.58	7.31x-61.88x	32.82-3.88	9.74x-82.5x	24.62-2.91	12.18x-103.13x	18.46-2.18
1x (W.D: 110 mm)	6.5x-55x	35.38-4.18	9.75x-82.5x	24.62-2.91	13.0x-110x	18.46-2.18	16.25x-137.5x	13.85-1.64
1.5x (W.D: 47 mm)	9.75x-82.5x	23.59-2.79	14.63x-123.75	16.41-1.94	19.5x-165x	12.31-1.45	24.38x-206.25x	9.23-1.09
2x (W.D: 26 mm)	13.0x-110.0x	17.69-2.09	19.5x-165x	12.31-1.45	26.0x-210x	9.23-1.09	32.5x-262.5x	6.92-0.82

## SZO-B and SZO-T Heads

Eyepiece	10x (ST-301)		15x (ST-302)		20x (ST-303)		25x (ST-144)	
Field number (mm)	23		16		12		9	
Objective	Total magnification	Field of View (mm)	Total magnification	Field of View (mm)	Total magnification	Field of View (mm)	Total magnification	Field of View (mm)
0.3x (W.D: 287 mm)	2.01x-13.5x	114.43-17.04	3.02x-20.25x	79.60-11.85	4.02x-27x	59.70-8.89	5.02x-33.75x	44.78-6.67
0.5x (W.D: 177 mm)	3.35x-22.5x	68.66-10.22	5.02x-33.75x	47.76-7.11	6.7x-45x	35.82-5.33	8.37x-56.25x	26.87-4.0
0.75x (W.D: 120 mm)	5.02x-33.75x	45.77-6.81	7.54x-50.62x	31.84-4.74	10.05x-67.5x	23.88-3.56	12.56x-84.37x	17.91-2.67
1x (W.D: 110 mm)	6.7x-45x	34.33-5.11	10.05x-67.5x	23.88-3.56	13.4x-90x	17.91-2.67	16.75x-112.5x	13.43-2.0
1.5x (W.D: 47 mm)	10.05x-67.5x	22.89-3.41	15.07x-101.25	15.92-2.37	20.1x-135x	11.94-1.78	25.12x-168.75x	8.96-1.33
2x (W.D: 26 mm)	13.4x-90.0x	17.16-2.56	20.1x-135x	11.94-1.78	26.8x-180x	8.96-1.33	33.5x-225x	6.72-1.0

# SZ Series - Best Selling Configurations



**SZO-B + SZ-A1 + SZ-ST1**



**SZX-B + SZ-A1 + SZ-ST3**



**SZX-BA + SZ-A1 + SZ-ST7**



**SZO-T + SZ-A1 + SZ-ST8**



**SZO-T + SZ-A1 + SZ-STL1**



**SZO-T + SZ-A1 + SZ-STL2**

# SZ Series - Accessories

## Eyecups & Eyepieces

ST-141	WF10x/22 eyepieces (pair), high eyepoint, focusable, rubber cup (only for SZX-B & SZX-T)
ST-145	WF10x/22 micrometric eyepiece, high eyepoint, focusable, rubber cup (only for SZX-B & SZX-T)
ST-144	WF25x/9 eyepieces (pair), high eyepoint, focusable, with rubber cup
ST-301	WF10x/23 eyepieces (pair), high eyepoint, focusable, with rubber cup (only for SZO-B & SZO-T)
ST-302	WF15x/16 eyepieces (pair), high eyepoint, focusable, with rubber cup
ST-303	WF20x/12 eyepieces (pair), high eyepoint, focusable, with rubber cup
ST-305	WF10x/23 micrometric eyepiece, high eyepoint, focusable, rubber cup (only for SZO-B & SZO-T)
ST-306	WF10x/23 eyepieces (pair), high eyepoint, focusable, rubber cup (only for SZX-BA & SZX-TA)
ST-310	WF10x/23 micrometric eyepiece, high eyepoint, focusable, rubber cup (only for SZX-BA & SZX-TA)

## Objectives & Additional Lenses

ST-102	Additional lens 0.3x (w.d. 287mm)
ST-103	Additional lens 0.5x (w.d. 177mm)
ST-104	Additional lens 0.75x (w.d. 120mm)
ST-105	Additional lens 1.5x (w.d. 47mm)
ST-106	Additional lens 2x (w.d. 26mm)

## Stages

ST-100	Hand moving stage, 95mm diameter
ST-110	Moving stage, coaxial knobs, 95mm diameter
ST-111	Moving stage, micrometric screws, 95mm diameter
ST-666-EU	Applicable heating stage (stereomicroscopes, 95mm diameter), EU
ST-666-UK	Applicable heating stage (stereomicroscopes, 95mm diameter), UK
ST-666-US	Applicable heating stage (stereomicroscopes, 95mm diameter), US
ST-666-SW	Applicable heating stage (stereomicroscopes, 95mm diameter), CH

## Condenser & Filters

ST-040	Darkfield condenser, 95mm diameter
ST-088	Polarising set (filters and rotating stage), 95mm diameter

## Camera Adapters

M-113.1	Ring adapter, 30mm (for monocular and binocular microscopes)
M-115	0.35x C-Mount projection lens
M-114	0.5x C-Mount projection lens
M-118	0.75x C-Mount projection lens
M-173	C-Mount projection lens for APS-C/full frame reflex cameras (trino)
M-699	Universal adapter for C-Mount projection lens (trino)
ST-090	0.35x focusable C-Mount adapter (stereomicroscopes)
ST-090.1	0.5x focusable C-Mount adapter (stereomicroscopes)
ST-090.2	0.65x focusable C-Mount adapter (stereomicroscopes)
M-620.3	1x focusable C-Mount adapter (biological & stereomicroscopes)

## Miscellaneous

15104	Cleaning kit
DC-002	Plastic dust cover, medium, 490(l)x490(h) mm
DC-003	TNT dust cover, medium, 600(l)x550(h) mm
DC-004	TNT dust cover, large, 700(l)x550(h) mm
M-005	Micrometric slide, 26x76mm, with 2 scales (1mm/100 & 10mm/100)
M-069	Solar charger
ST-012	White/black object-plate, 95mm diameter
ST-014	Glass object-plate, 95mm diameter
ST-041	Sample clip
ST-092	Protective glass for stereohead
VP-SZ	IQ/OQ/PQ manual for SZ series

### 15104 - Cleaning kit

It cleans glass quickly and effectively, without leaving residue or odor. Ideal for precision lens or prism cleaning.



### How to connect the cameras to our microscopes.

Please refer to the Adapter reference list on Digital section.

v 1.4.0 - OPTIKA reserves the right to make corrections, modifications, enhancements, improvements and other changes to its products at any time without notice.

## Headquarters and Manufacturing Facilities

**OPTIKA® S.r.l.** Via Rigla, 30 - 24010 Ponteranica (BG) - ITALY - Tel.: +39 035.571.392 - info@optikamicroscopes.com

## Optika Sales branches

**OPTIKA® Spain** spain@optikamicroscopes.com  
**OPTIKA® China** china@optikamicroscopes.com  
**OPTIKA® India** india@optikamicroscopes.com

**OPTIKA® USA** usa@optikamicroscopes.com  
**OPTIKA® Central America** camerica@optikamicroscopes.com



## SZM Series



**Stereozoom Microscopes for Routine Inspections**

# FIELD OF VIEW - 21 mm Full Plan Field of View

## 10x/21mm PLAN EYEPIECES

Plan eyepieces with 21 mm field of view; high eye-point type, also suitable for the use of eyeglasses.

## ZOOM OBJECTIVE

The High-Grade Zoom Objective grants a sharp and clear vision. With a zoom ratio of 6.43:1 it makes this series a perfect instrument for any application.



# X-LED - Two Times Brighter Than Any Other



## X-LED: A SEA OF LIGHT

On LED models both illuminators are equipped with X-LED systems:

- the incident illuminator with **X-LED<sup>3</sup>** (single LED, 3.6W)
- the transmitted illuminator with **X-LED<sup>11</sup>** (18 LEDs)

## X-LED: RESPECTING COLORS

With 6,300K color temperature the samples are illuminated with the most natural light. It allows to respect their colors, without altering the nuances.



Multi-plug power supply

# SZM Series

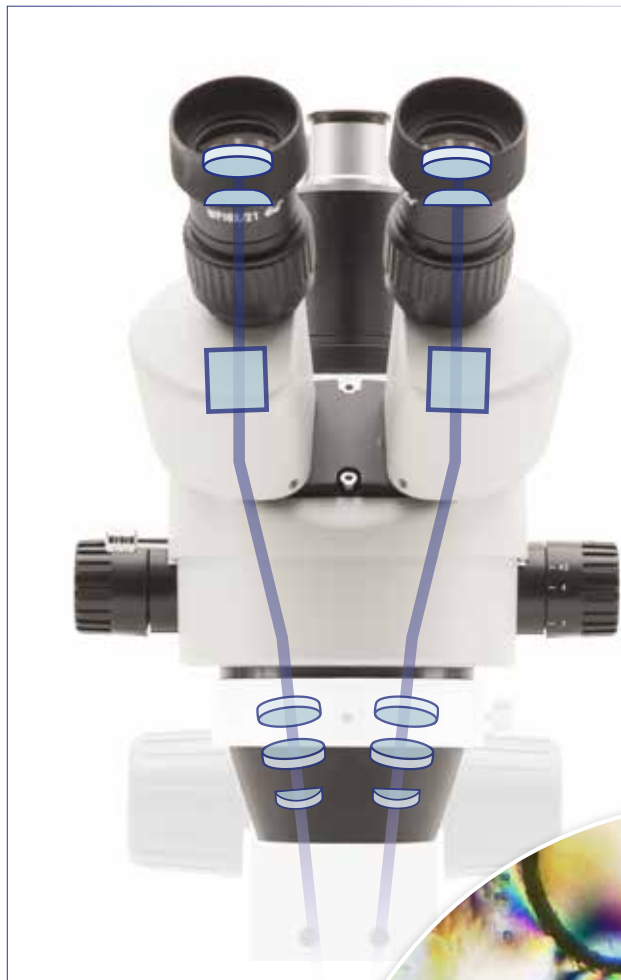

### Greenough Optical System

The V-shape optical path of Greenough allows us to design a very compact and a slim unit, highly versatile and appreciated for the 3D viewing. Samples with significant depth can be quickly inspected. Binocular and trinocular heads are 45° inclined to grant comfortable posture to the user even after several hours of operation.

### 6.43:1 Zoom Ratio

SZM Series has 0.7x-4.5x zoom range (6.43:1 zoom ratio), being purposely designed for routine inspections. This zoom ratio enables most samples to be observed at the appropriate magnifications. When combined with proper accessories (2x additional lens and 20x eyepieces), SZM delivers excellent images up to 180x.

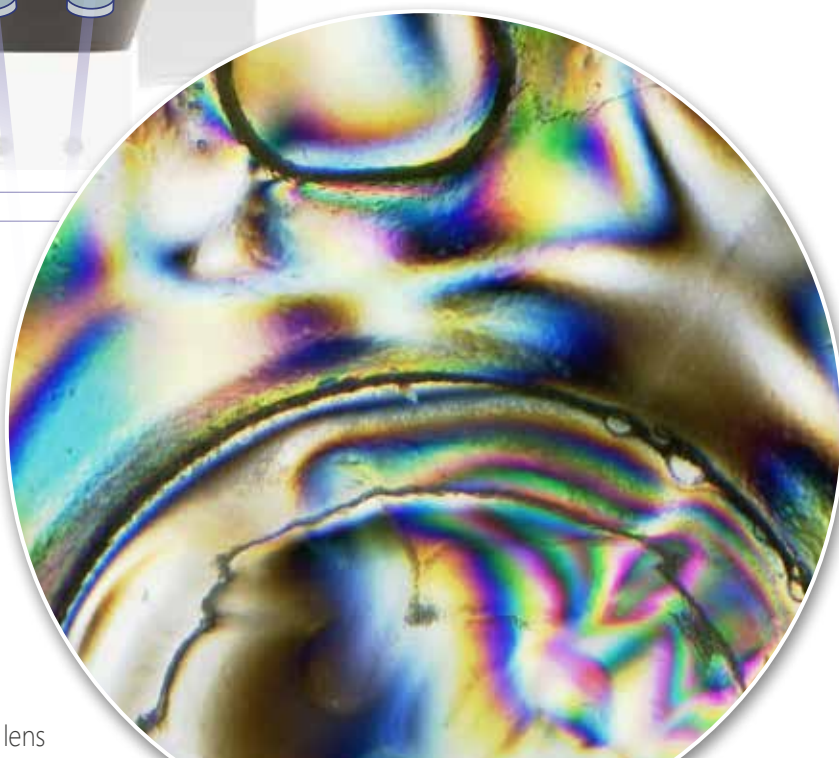

**Plastic lens - 4.5x zoom - SZM-LED2 Polarizing**

# Stereozoom Microscopes for Routine Inspections

## Overhanging Stand, In Case Of Large Samples

This stand is recommended for efficient, quick and precise observation and digital imaging of large samples, that cannot be processed with regular stands.

Achieve 360° rotation and smooth movement with no limits, as the mechanism can be tilted from right to left, backward to forward.

## X-LED<sup>3</sup> Exclusive Lighting Source

Special technology able to double the light intensity for incomparable performance, ensuring constant pure-white colour temperature.

Relevant money & energy saving thanks to the incredibly low energy consumptions allow you to cut the electricity bills by 90%!

On SZM-LED1, SZM-LED2



## Get the most out of our accessories



### ST-088.1 - Polarizing set

Polarizing set ST-088.1 is composed of a rotating polarizing stage (with graduation), a analyzer filter and it is the ideal accessory for analysis of birefringent materials.

Polarization is primarily used in the field of geology or petrography for the study of rocks and minerals, or many other applications, including medicine, chemistry, biology and metallurgy.

Materials that can be examined under a polarized microscope include minerals, ceramics, polymers, wood, urea, natural and synthetic fibers.

## SZM Series

### Applications

Some application examples demonstrating the versatility of SZM series. Routine applications are extremely facilitated!

### Legend

1. SZM-LED2 with darkfield condenser.
2. Salt crystal, with SZM-LED2, 0.7x zoom with darkfield.
3. Mechanical part, with SZM-LED1, 1.5x zoom.
4. Electronic board, with SZM-2, 2x zoom.
5. QC of a mechanical component, with SZM-3.
6. Fine art inspection, with SZM-4 and CLD-01 + CL-11.1 illuminator.
7. Textile fiber, with, 4x zoom.

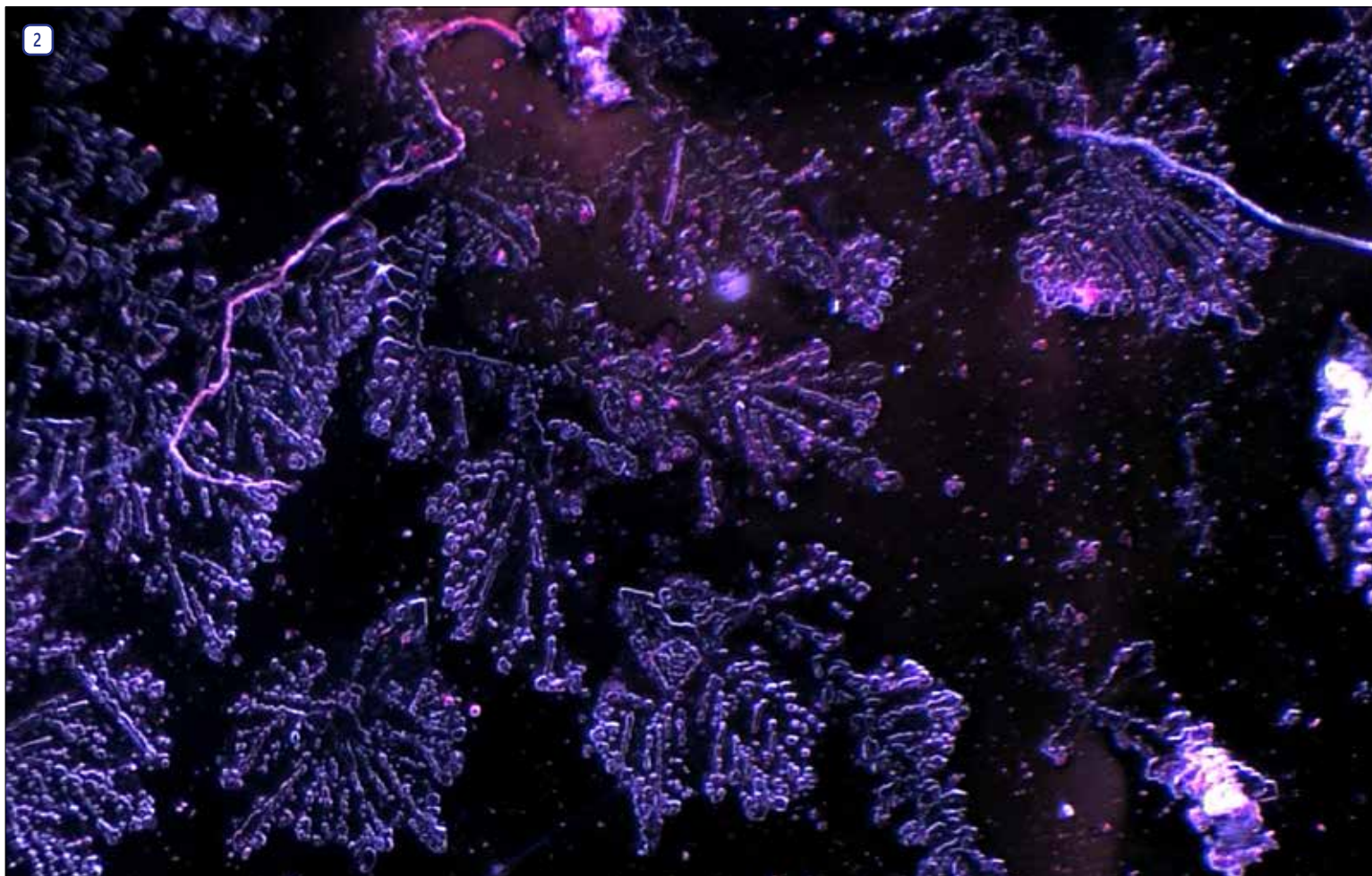
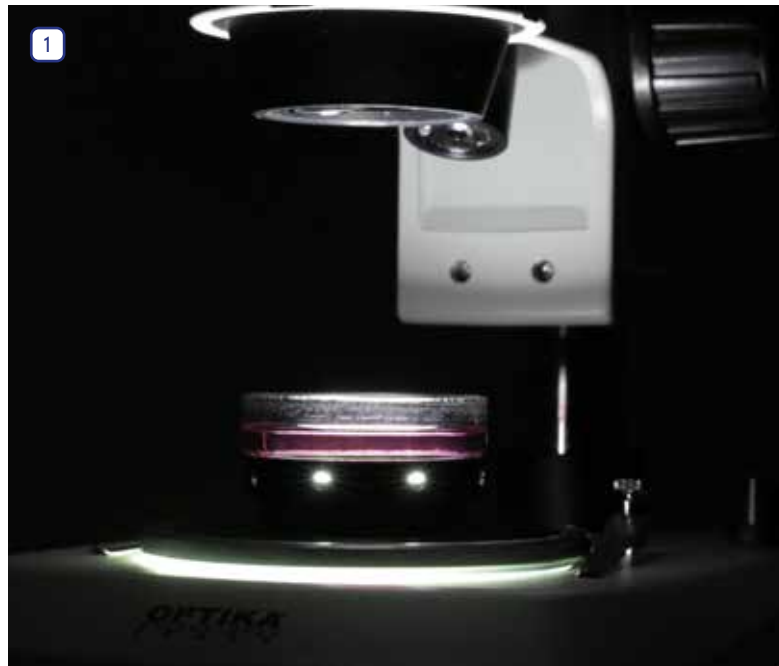

# Stereozoom Microscopes For Routine Inspections

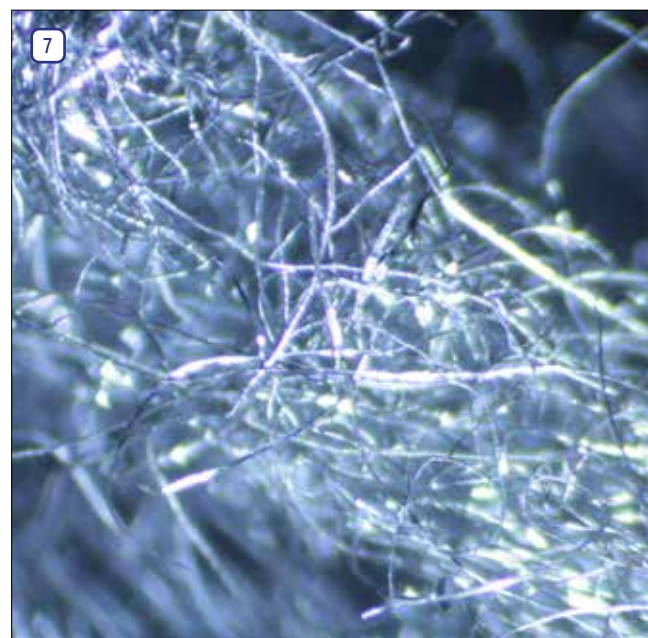
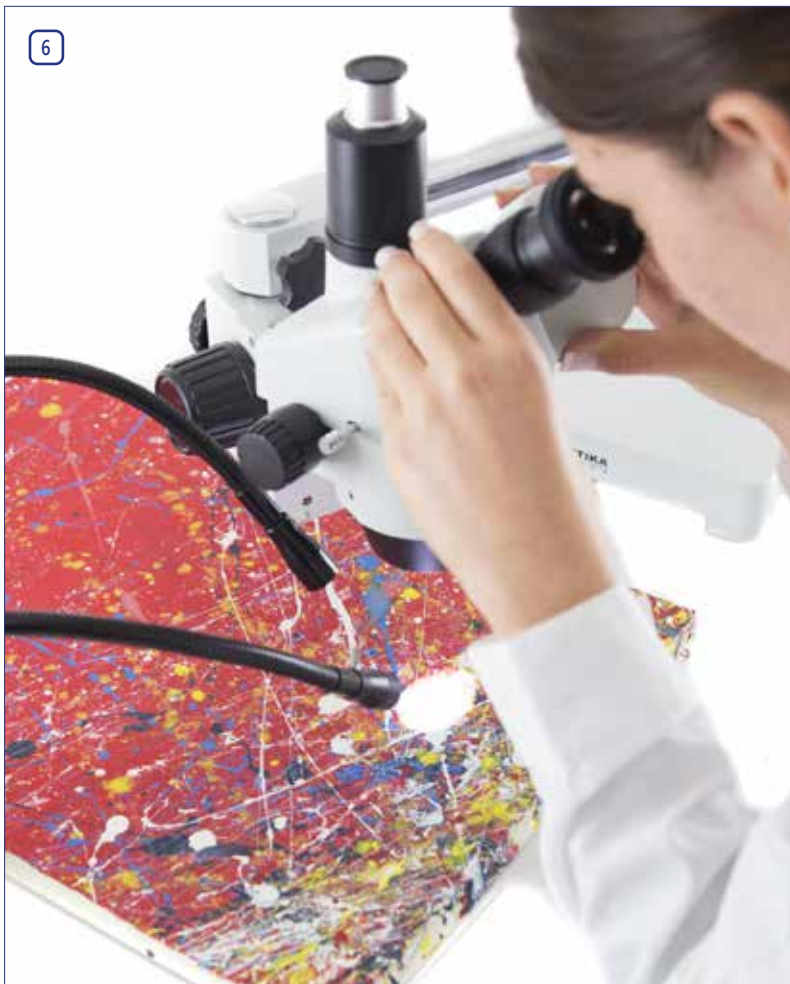

# 3 SZM Series - Heads

## SZM-B



Part	Description
<b>Head:</b>	Binocular, 360° rotating on all stands and 45° inclined.
<b>Interpup. distance:</b>	Adjustable between 51 and 75 mm.
<b>Dioptric adjustment:</b>	On both eyepiece tubes.
<b>Eyepieces:</b>	WF10x/21 mm, high eye-point.
<b>Objective:</b>	Parfocal achromatic zoom 0.7x...4.5x (zoom factor 6.43:1).
<b>Working distance:</b>	100 mm

## SZM-T



Part	Description
<b>Head:</b>	Trinocular, 360° rotating on all stands and 45° inclined. 2-position photo port: 100/0 and 0/100 (on right eyepiece tube).
<b>Interpup. distance:</b>	Adjustable between 51 and 75 mm.
<b>Dioptric adjustment:</b>	On both eyepiece tubes.
<b>Eyepieces:</b>	WF10x/21 mm, high eye-point.
<b>Objective:</b>	Parfocal achromatic zoom 0.7x...4.5x (zoom factor 6.43:1).
<b>Working distance:</b>	100 mm



# SZM Series - Range

## SZM-1



Binocular stereomicroscope with pillar stand and illuminated stage with halogen transmitted and incident illumination, freely settable.

**Observation mode:** Brightfield.

**Head:** Binocular, 45° inclined, 360° rotating.

**Interpupillary distance:** Adjustable between 51 and 75 mm.

**Dioptric adjustment:** On both eyepiece tubes.

**Eyepieces:** WF10x/21 mm, high eye-point.

**Objective:** Parfocal achromatic zoom 0.7x...4.5x (zoom factor 6.43:1).

**Working distance:** 100 mm.

**Specimen stage:** Fitted with a black/white disc, specimen clips and a frosted disc for transmitted light.

**Focusing:** Rack and pinion mechanism controlled by a pair of knobs placed on both sides of the stand.

**Stand:** Pillar stand 32 mm diameter and 250 mm high, base: 260x200x60h mm.

**Illumination:** Double, adjustable incident and transmitted light with separated brightness controls, fitted with two 12 V/15 W halogen bulbs.

## SZM-2



Trinocular stereomicroscope with pillar stand and illuminated stage with halogen transmitted and incident illumination, freely settable.

**Observation mode:** Brightfield.

**Head:** Trinocular, 45° inclined, 360° rotating.  
2-position photo port: 100/0 and 0/100 (on right eyepiece tube).

**Interpupillary distance:** Adjustable between 51 and 75 mm.

**Dioptric adjustment:** On both eyepiece tubes.

**Eyepieces:** WF10x/21 mm, high eye-point.

**Objective:** Parfocal achromatic zoom 0.7x...4.5x (zoom factor 6.43:1).

**Working distance:** 100 mm.

**Specimen stage:** Fitted with a black/white disc, specimen clips and a frosted disc for transmitted light.

**Focusing:** Rack and pinion mechanism controlled by a pair of knobs placed on both sides of the stand.

**Stand:** Pillar stand 32 mm diameter and 250 mm high, base: 260x200x60h mm.

**Illumination:** Double, adjustable incident and transmitted light with separated brightness controls, fitted with two 12 V/15 W halogen bulbs.

## SZM-LED1

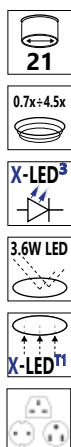

Binocular stereomicroscope, pillar stand and ultra-flat base, illuminated stage with **X-LED<sup>T1</sup>** transmitted illumination and **X-LED<sup>3</sup>** incident illumination for outstanding brightness, freely settable.

**Observation mode:** Brightfield.

**Head:** Binocular, 45° inclined, 360° rotating.

**Interpupillary distance:** Adjustable between 51 and 75 mm.

**Dioptric adjustment:** On both eyepiece tubes.

**Eyepieces:** WF10x/21 mm, high eye-point.

**Objective:**

**Working distance:** 100 mm.

**Specimen stage:** Fitted with a black/white disc, specimen clips and a diffusing disc for transmitted light.

**Specimen stage:** Fitted with a black/white disc, specimen clips and a diffusing disc for transmitted light.

**Focusing:** Rack and pinion mechanism controlled by a pair of knobs placed on both sides of the stand.

**Stand:** Pillar stand 32 mm diameter and 315 mm high, base: 270x205x30h mm.

**Illumination:** Double, adjustable incident and transmitted light with separated brightness controls and 6,300K color temperature:

**Incident illuminator:** **X-LED<sup>3</sup>** (single LED, 3.6W).

**Transmitted illuminator:** **X-LED<sup>T1</sup>** (18 LEDs).

Multi-plug 100-240Vac/6Vdc external power supply.

## SZM-LED2

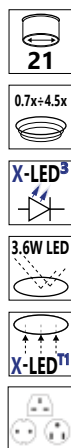

Trinocular stereomicroscope, pillar stand and ultra-flat base, illuminated stage with **X-LED<sup>T1</sup>** transmitted illumination and **X-LED<sup>3</sup>** incident illumination for outstanding brightness, freely settable.

**Observation mode:** Brightfield.

**Head:** Trinocular, 45° inclined, 360° rotating.  
2-position photo port: 100/0 and 0/100 (on right eyepiece tube).

**Interpupillary distance:** Adjustable between 51 and 75 mm.

**Dioptric adjustment:** On both eyepiece tubes.

**Eyepieces:** WF10x/21 mm, high eye-point.

**Objective:** Parfocal achromatic zoom 0.7x...4.5x (zoom factor 6.43:1).

**Working distance:** 100 mm.

**Specimen stage:** Fitted with a black/white disc, specimen clips and a diffusing disc for transmitted light.

**Focusing:** Rack and pinion mechanism controlled by a pair of knobs placed on both sides of the stand.

**Stand:** Pillar stand 32 mm diameter and 315 mm high, base: 270x205x30h mm.

**Illumination:** Double, adjustable incident and transmitted light with separated brightness controls and 6,300K color temperature:

**Incident illuminator:** **X-LED<sup>3</sup>** (single LED, 3.6W).

**Transmitted illuminator:** **X-LED<sup>T1</sup>** (18 LEDs).

Multi-plug 100-240Vac/6Vdc external power supply.

# SZM Series - Range

## SZM-3



Binocular stereomicroscope with extremely stable overhanging stand complete of head holder and focusing system for perpendicular observation of particularly large specimens. Smooth horizontal and vertical movement are ensured. In case illumination is needed, choose from the wide choice of external illuminators available.

**Observation mode:** Brightfield.

**Head:** Binocular, 45° inclined, 360° rotating.

**Interpupillary distance:** Adjustable between 51 and 75 mm.

**Dioptric adjustment:** On both eyepiece tubes.

**Eyepieces:** WF10x/21 mm, high eye-point.

**Objective:** Parfocal achromatic zoom 0.7x...4.5x (zoom factor 6.43:1).

**Working distance:** 100 mm.

**Focusing:** Rack and pinion mechanism controlled by a pair of knobs placed on both sides of the stand.

**Stand:** Overhanging stand 420 mm high, 430 mm horizontal arm length, base 230x230 mm with following adjustments: height, longitudinal extension and head rotation angle (left-right).

## SZM-4



Trinocular stereomicroscope with extremely stable overhanging stand complete of head holder and focusing system for perpendicular observation of particularly large specimens. Smooth horizontal and vertical movement are ensured. In case illumination is needed, choose from the wide choice of external illuminators available.

**Observation mode:** Brightfield.

**Head:** Trinocular, 45° inclined, 360° rotating.

2-position photo port: 100/0 and 0/100 (on right eyepiece tube).

**Interpupillary distance:** Adjustable between 51 and 75 mm.

**Dioptric adjustment:** On both eyepiece tubes.

**Eyepieces:** WF10x/21 mm, high eye-point.

**Objective:** Parfocal achromatic zoom 0.7x...4.5x (zoom factor 6.43:1).

**Working distance:** 100 mm.

**Focusing:** Rack and pinion mechanism controlled by a pair of knobs placed on both sides of the stand.

**Stand:** Overhanging stand 420 mm high, 430 mm horizontal arm length, base 230x230 mm with following adjustments: height, longitudinal extension and head rotation angle (left-right).

# SZM-D



Digital binocular stereomicroscope with simultaneous view from both eyepieces and camera. The built-in camera can be connected to any PC.

**Observation mode:** Brightfield.

**Head:** Binocular, 45° inclined, 360° rotating.

**Interpupillary distance:** Adjustable between 51 and 75 mm.

**Dioptric adjustment:** On both eyepiece tubes.

**Eyepieces:** WF10x/21 mm, high eye-point.

**Objective:** Parfocal achromatic zoom 0.7x..4.5x (zoom factor 6.43:1).

**Working distance:** 100 mm.

**Specimen stage:** Fitted with a black/white disc, specimen clips and a frosted disc for transmitted light.

**Focusing:** Rack and pinion mechanism controlled by a pair of knobs placed on both sides of the stand.

**Stand:** Pillar stand 32 mm diameter and 250 mm high, base: 260x200x60h mm.

**Illumination:** Double, adjustable incident and transmitted light with separated brightness controls, fitted with two 12 V/15 W halogen bulbs.



## Technical specifications of the built-in camera

Resolution	1280 x 1024 pixels (1.3 MP)
Sensor	CMOS 1/3"
Pixel Size	3.6 μm x 3.6 μm
Frame Rate at Full Resolution	15 frames/sec
Frame Rate at 640x480	55 frames/sec
Optical Format	1/3"
Aspect Ratio	4:3
S/N Ratio	44 dB
Dynamic Range	71 dB
ADC	8 bit
Sensitivity	1.0V/Lux-second
System Requirements	Windows XP/Vista, Win7, Win8, Win10, 32/64bit, USB 2.0
Software	Optika Vision Lite, Optika view, TWAIN interface, several freeware for image elaboration
Capture Features	Continuous auto white balance, continuous auto exposure

# SZM Series - Comparison Chart

Model	Head	Eyepieces	Objectives	Working Distance	Stand	Illuminator
<b>SZM-1</b>	Binocular, 360° rotating, 45° inclined	Wide Field 10x/21mm, high eye-point	0.7x...4.5x zoom	100 mm	Pillar stand	Incident and transmitted 12V/15W halogen with separated brightness controls
<b>SZM-LED1</b>	Binocular, 360° rotating, 45° inclined	Wide Field 10x/21mm, high eye-point	0.7x...4.5x zoom	100 mm	Pillar stand	<b>Incident:</b> high power single X-LED <sup>3</sup> <b>Transmitted:</b> X-LED <sup>T1</sup> diffusing disc with separated brightness controls
<b>SZM-2</b>	Trinocular, 360° rotating, 45° inclined	Wide Field 10x/21mm, high eye-point	0.7x...4.5x zoom	100 mm	Pillar stand	Incident and transmitted 12V/15W halogen with separated brightness controls
<b>SZM-LED2</b>	Trinocular, 360° rotating, 45° inclined	Wide Field 10x/21mm, high eye-point	0.7x...4.5x zoom	100 mm	Pillar stand	<b>Incident:</b> high power single X-LED <sup>3</sup> <b>Transmitted:</b> X-LED <sup>T1</sup> diffusing disc with separated brightness controls
<b>SZM-3</b>	Binocular, 360° rotating, 45° inclined	Wide Field 10x/21mm, high eye-point	0.7x...4.5x zoom	100 mm	Overhanging stand	Without illumination; External light source needed
<b>SZM-4</b>	Trinocular, 360° rotating, 45° inclined	Wide Field 10x/21mm, high eye-point	0.7x...4.5x zoom	100 mm	Overhanging stand	Without illumination; External light source needed
<b>SZM-D</b>	Binocular, 360° rotating, 45° inclined	Wide Field 10x/21mm, high eye-point	0.7x...4.5x zoom	100 mm	Pillar stand	Incident and transmitted 12V/15W halogen with separated brightness controls

## SZM Series - Optical Performance

Eyepiece	10x (ST-081)		15x (ST-082)		20x (ST-083)	
Field number (mm)	21		15		10	
Objective	Total magnification	Field of View (mm)	Total magnification	Field of View (mm)	Total magnification	Field of View (mm)
0.5x (W.D. 165 mm)	3.5x-22.5x	60.00-9.23	5.25x-33.75x	42.86-6.67	7x-45x	28.57-4.44
0.75x (W.D. 117 mm)	5.25x-33.75x	40.00-6.22	7.875x-50.625x	28.57-4.44	10.50x-67.5x	19.05-2.96
1x (W.D. 100 mm)	7x-45x	30.00-4.66	10.5x-67.5x	21.43-3.33	14x-90x	14.29-2.22
1.5x (W.D. 47 mm)	10.50x-67.5x	20.00-3.11	15.75x-101.25x	14.29-2.22	21x-135x	9.52-1.48
2x (W.D. 33 mm)	14x-90x	15.00-2.33	21x-135x	10.71-1.67	28x-180x	7.14-1.11

## SZM Series - Zoom Comparison

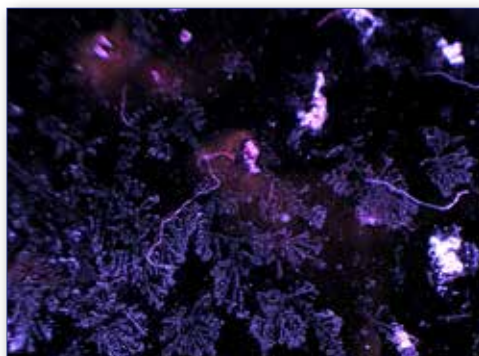

Salt crystal- SZM-LED2 - 0.7x zoom

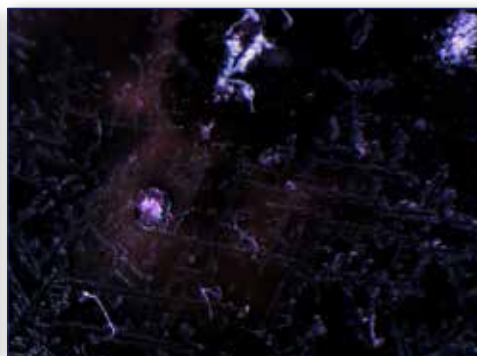

Salt crystal- SZM-LED2 - 3x zoom

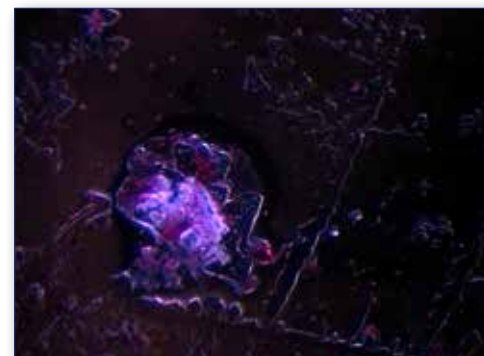

Salt crystal- SZM-LED2 - 4x zoom

# SZM Series - Accessories

## Eyecups & Eyepieces

- ST-036 Eyecups (pair), curved
- ST-081 EW10x/21 eyepieces (pair), high eyepoint, with rubber cup
- ST-082 WF15x/15 eyepieces (pair), high eyepoint
- ST-083 WF20x/10 eyepieces (pair), high eyepoint
- ST-084 WF10x/21 micrometric eyepiece, high eyepoint, with rubber cup

## Objectives & Additional Lenses

- ST-091 Additional lens 0.75x (w.d. 105mm)
- ST-087 Additional lens 2x (w.d. 33mm)

## Stages

- ST-100 Hand moving stage, 95mm diameter (only for SZM-1, SZM-2 and SZM-D)
- ST-110 Moving stage, coaxial knobs, 95mm diameter (only for SZM-1, SZM-2 and SZM-D)
- ST-100.1 Hand moving stage, 100mm diameter (only for SZM-LED1 & SZM-LED2)
- ST-110.1 Moving stage, coaxial knobs, 100mm diameter (only for SZM-LED1 & SZM-LED2)
- ST-111 Moving stage, micrometric screws, 95mm diameter (only for SZM-1, SZM-2 and SZM-D)
- ST-111.1 Moving stage, micrometric screws, 100mm diameter (only for SZM-LED1 & SZM-LED2)
- ST-666 Applicable heating stage (stereomicroscopes, 95mm diameter), EU (only for SZM-1, SZM-2 and SZM-D)
- ST-666.1 Applicable heating stage (stereomicroscopes, 100mm diameter), EU (only for SZM-LED1 & SZM-LED2)

## Condenser & Filters

- ST-040 Darkfield condenser, 95mm diameter (only for SZM-1, SZM-2 and SZM-D)
- ST-040.1 Darkfield condenser, 100mm diameter (only for SZM-LED1 & SZM-LED2)
- ST-088 Polarising set (filters and rotating stage), 95mm diameter (only for SZM-1, SZM-2 and SZM-D)
- ST-088.1 Polarising set (filters and rotating stage), 100mm diameter (only for SZM-LED1 & SZM-LED2)

## Camera Adapters

- M-113.1 Ring adapter, 30mm (for monocular and binocular microscopes)
- M-115 0.35x C-Mount projection lens
- M-114 0.5x C-Mount projection lens
- M-118 0.75x C-Mount projection lens
- M-173 C-Mount projection lens for APS-C/full frame reflex cameras (trino)
- M-699 Universal adapter for C-Mount projection lens (trino)
- ST-090 0.35x focusable C-Mount adapter (stereomicroscopes)
- ST-090.1 0.5x focusable C-Mount adapter (stereomicroscopes)
- ST-090.2 0.65x focusable C-Mount adapter (stereomicroscopes)
- M-620.3 1x focusable C-Mount adapter (biological & stereomicroscopes)

## Miscellaneous

- 15104 Cleaning kit
- DC-002 Plastic dust cover, medium, 490(l)x490(h) mm
- DC-003 TNT dust cover, medium, 600(l)x550(h) mm
- DC-004 TNT dust cover, large, 700(l)x550(h) mm
- M-005 Micrometric slide, 26x76mm, with 2 scales (1mm/100 & 10mm/100)
- ST-012 White/black object-plate, 95mm diameter (only for SZM-1, SZM-2 and SZM-D)
- ST-014 Glass object-plate, 95mm diameter (only for SZM-1, SZM-2 and SZM-D)
- ST-037 Halogen bulb 12V/15W, with dichroic mirror (only for SZM-1, SZM-2 and SZM-D)
- ST-038 Halogen bulb 12V/15W (only for SZM-1, SZM-2 and SZM-D)
- ST-041 Sample clip (only for SZM-1, SZM-2, SZM-LED1 and SZM-LED2)
- ST-042 White/black object-plate, 100mm diameter (only for SZM-LED1 & SZM-LED2)
- ST-043 Glass object-plate, 100mm diameter (only for SZM-LED1 & SZM-LED2)
- ST-092 Protective glass for stereohead
- VP-SZM IQ/OQ/PQ manual for SZM series

### 15104 - Cleaning kit

It cleans glass quickly and effectively, without leaving residue or odor. Ideal for precision lens or prism cleaning.



### How to connect the cameras to our microscopes.

Please refer to the Adapter reference list on Digital section.

v 1.4.0 - OPTIKA reserves the right to make corrections, modifications, enhancements, improvements and other changes to its products at any time without notice.

## Headquarters and Manufacturing Facilities

**OPTIKA® S.r.l.** Via Rigla, 30 - 24010 Ponteranica (BG) - ITALY - Tel.: +39 035.571.392 - info@optikamicroscopes.com

## Optika Sales branches

**OPTIKA® Spain** spain@optikamicroscopes.com  
**OPTIKA® China** china@optikamicroscopes.com  
**OPTIKA® India** india@optikamicroscopes.com

**OPTIKA® USA** usa@optikamicroscopes.com  
**OPTIKA® Central America** camerica@optikamicroscopes.com

## SZO Series



**Stereozoom Microscopes For Laboratory & Industry**

# FIELD OF VIEW - 23 mm Full Plan Field of View

## 10x/23mm PLAN EYEPIECES

Plan eyepieces with 23 mm field of view; high eye-point type, also suitable for the use of eyeglasses.

## ZOOM OBJECTIVE

The High-Grade Zoom Objective grants a sharp and clear vision. With a zoom ratio of 6.72:1 it makes this series a perfect instrument for any application.



## CLICK-STOP DETENTS

The zoom objective is equipped with a precise click-stop mechanism which makes easy to quickly find the default zoom positions: 0.67x, 0.80x, 1x, 1.2x, 1.5x, 2x, 2.5x, 3x, 3.5x, 4x, and 4.5x.





# X-LED - Two Times Brighter Than Any Other



## X-LED: A SEA OF LIGHT

Where present, both illuminators are equipped with X-LED systems:

- the incident illuminator with **X-LED<sup>3</sup>** (single LED, 3.6W)
- the transmitted illuminator with **X-LED<sup>T3</sup>** (60 LEDs)

## X-LED: RESPECTING COLORS

With 6,300K color temperature the samples are illuminated with the most natural light. It allows to respect their colors, without altering the nuances.



## X-LED<sup>T3</sup>: SIMPLY UNMATCHABLE

Top class illuminator for transmitted light. With 60 LEDs geometrically arranged, it grants a perfect light uniformity and the observation of large samples thanks to its 10cm diameter.



Multi-plug power supply

## SZO Series

### Greenough Optical System

The V-shape optical path of Greenough allows us to design a very compact and a slim unit, highly versatile and appreciated for the 3D viewing. Samples with significant depth can be quickly inspected. Binocular and trinocular heads are 45° inclined to grant comfortable posture to the user even after several hours of operation.

### 6.72:1 Zoom Ratio

SZO Series has 0.67x-4.5x zoom range (6.72:1 zoom ratio), being purposely designed for routine inspections. This zoom ratio enables most samples to be observed at the appropriate magnifications. When combined with proper accessories (2x additional lens and 25x eyepieces), SZO delivers excellent image quality up to 225x.

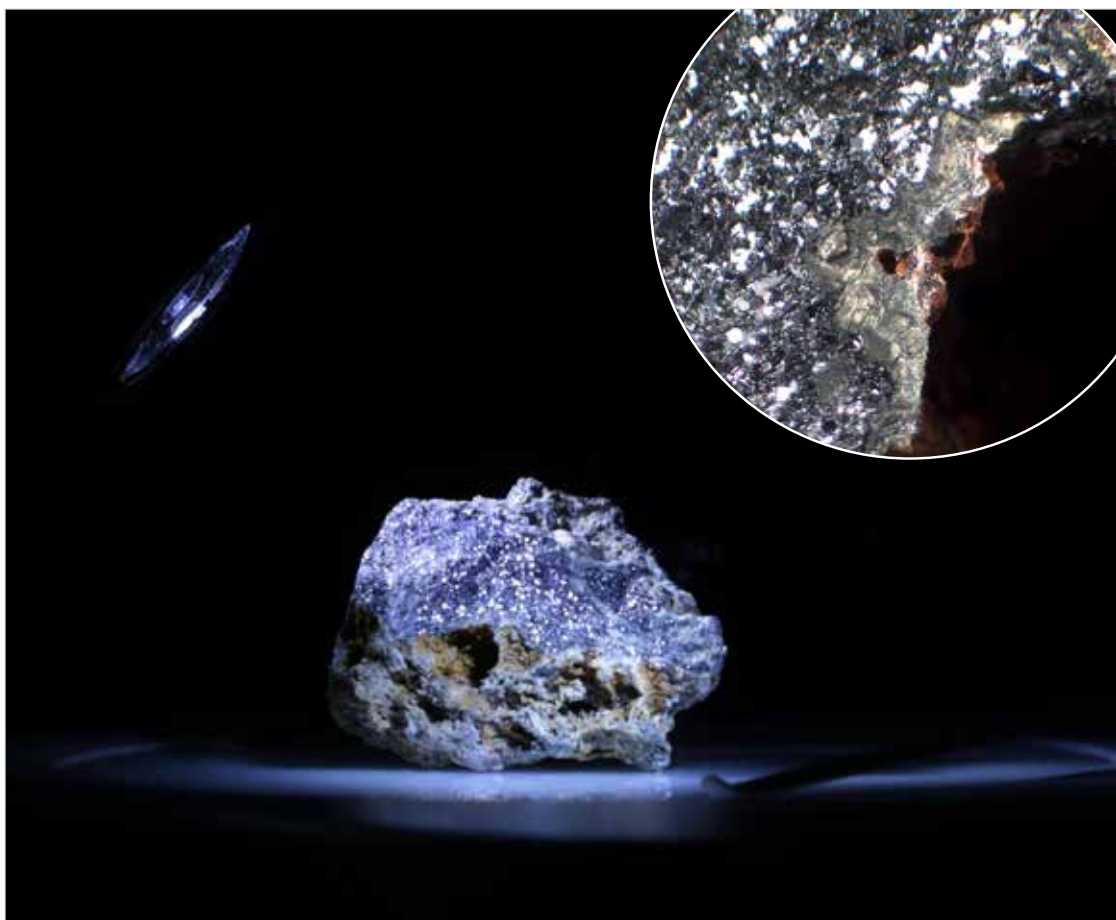

### X-LED Exclusive Lighting Source

Special technology able to double the light intensity for incomparable performance, ensuring constant pure-white colour temperature.

Relevant money & energy saving thanks to the incredibly low energy consumptions allow you to cut the electricity bills by 90%! On SZO-3, SZO-4, SZO-5, SZO-6.

# Stereozoom Microscopes For Laboratory & Industry

## Overhanging Stand, In Case Of Large Samples

This stand is recommended for efficient, quick and precise observation and digital imaging of large samples, that cannot be processed with regular stands. Achieve 360° rotation and smooth movement with no limits, as the mechanism can be tilted from right to left, backward to forward. On SZO-7, SZO-8, SZO-9, SZO-10.

## Large Working Distance And Field Of View Size Are Important!

If you need to work under the microscope, you will need a large working distance. SZO Series ensures an extended working distance of 110mm compared to the standard 100mm. Keep in my mind your application, always: if you are soldering a printed circuit board, it may be more important to have a long working distance; if you are counting items, then a large field of view will be of great assistance.

**LWD  
110mm**



## Get the most out of our accessories

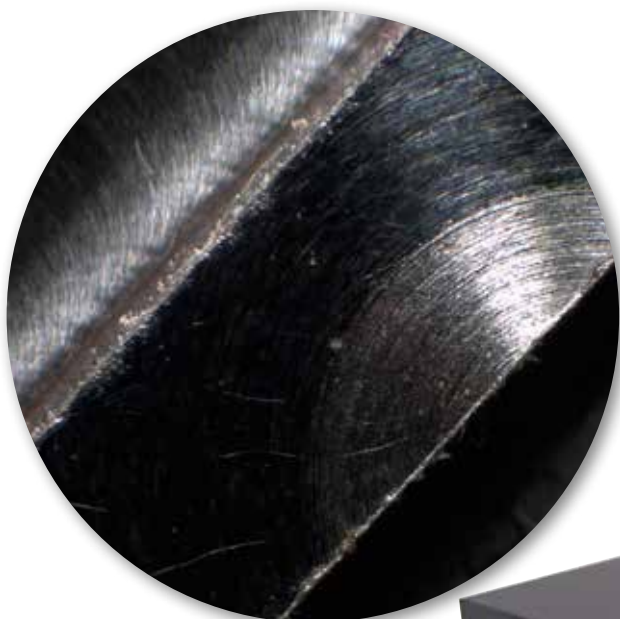

### ST-111.1 - Moving stage

Moving stage ST-111.1 is a micrometer positioning stage with XY graduation of 0.01mm. Whenever you need to precisely move the sample or make measurements, this is the ideal solution. It works with both incident and transmitted illumination, and it is equipped with rotating stage and sample clips. It is suggested to use it in conjunction with the optional micrometer eyepieces.



## SZO Series

### Applications

Some application examples demonstrating the versatility of SZO series. Applications in industrial and research are extremely facilitated by the advanced functionality offered.

### Legend

1. Mineral rock, with SZO-5.
2. Orchid petal, with SZO-6 and X-LED transmitted light.
3. Orchid petal, with SZO-6, 0.67x zoom.
4. Orchid petal, with SZO-6, 4.5x zoom.
5. Mechanical component, with SZO-4, 0.67x zoom.
6. Trunk wisteria sinensis, with SZO-8, 3.5x zoom.
7. Solanum, with SZO-6, 0.67x zoom.
8. Embossed paper, with SZO-6, 0.67x zoom.
9. Foam, with SZO-8, 2x zoom.

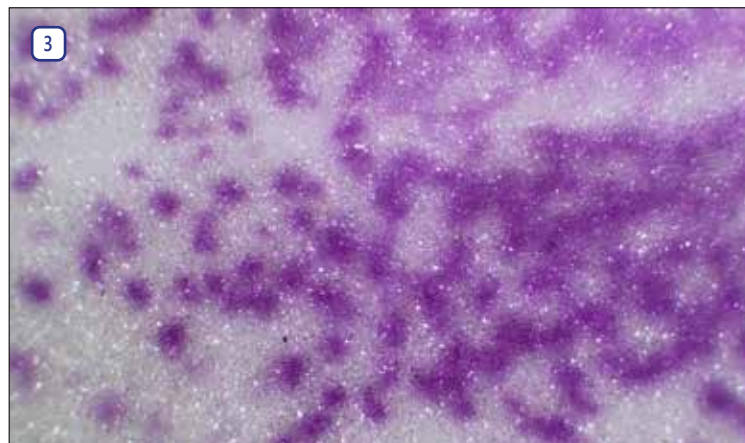
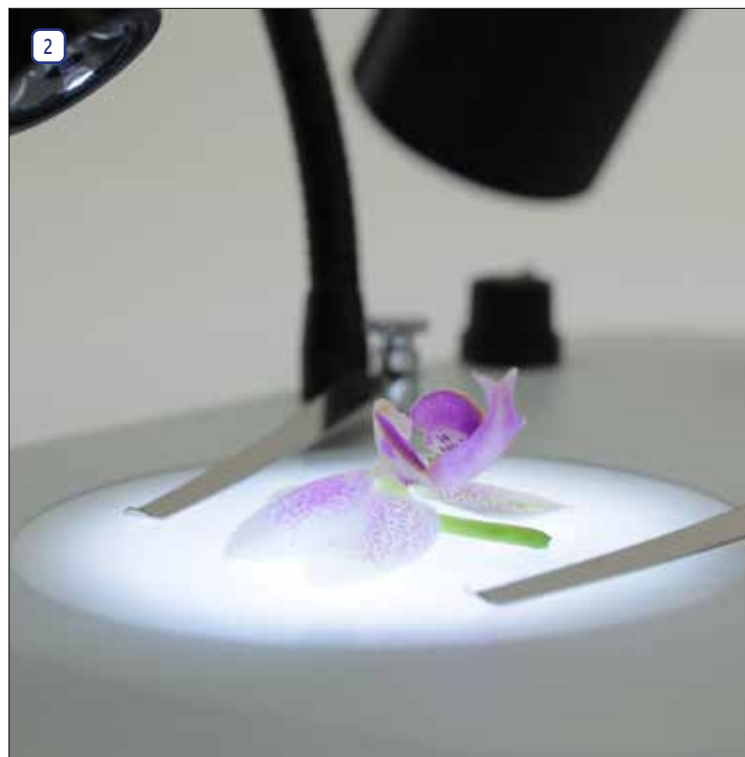

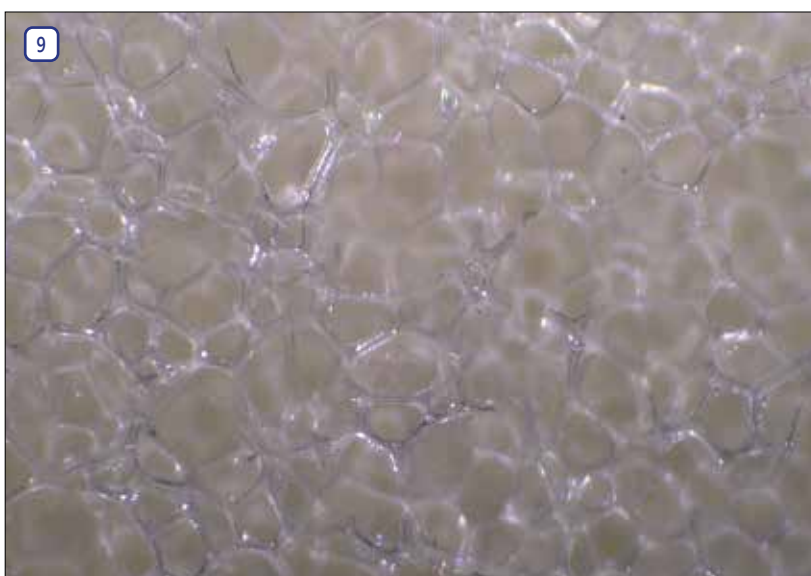
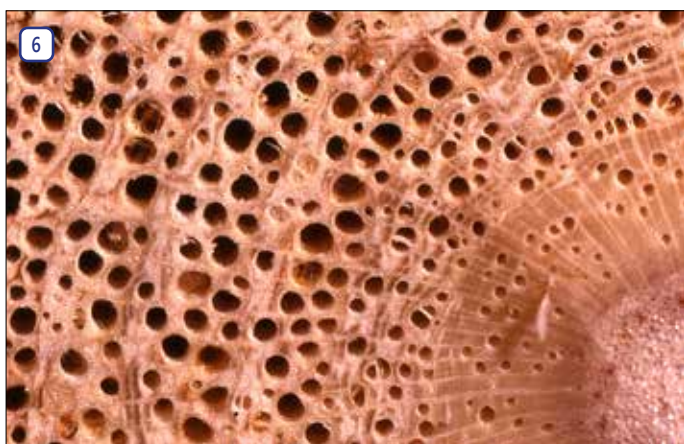
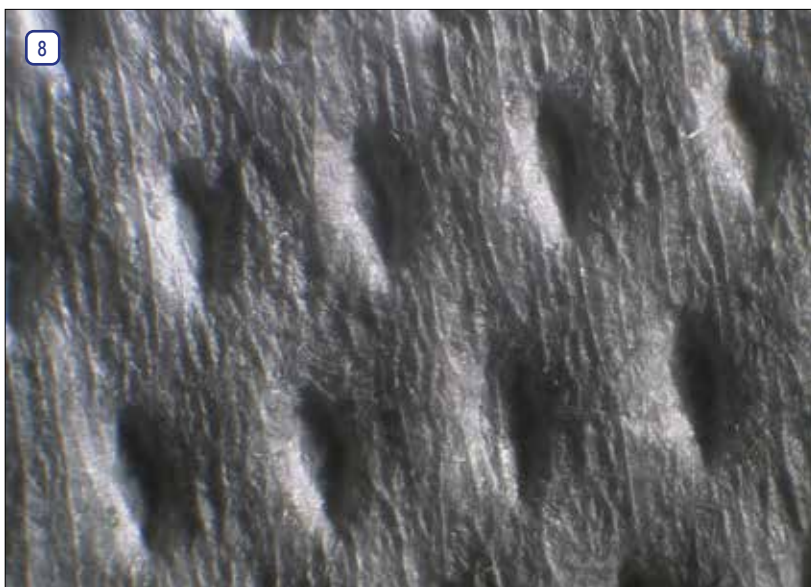

# SZO Series - Heads

## SZO-B



Part	Description
<b>Head:</b>	Binocular, 360° rotating on all stands and 45° inclined.
<b>Interpup. distance:</b>	Adjustable between 51 and 75 mm.
<b>Dioptric adjustment:</b>	On both eyepieces.
<b>Eyepieces:</b>	WF10x/23 mm, high eye-point.
<b>Objective:</b>	Parfocal achromatic zoom 0.67x...4.5x (zoom factor 6.72:1) with click-stop detents.
<b>Working distance:</b>	110 mm

## SZO-T



Part	Description
<b>Head:</b>	Trinocular (fixed photo port 70/30), 360° rotating on all stands and 45° inclined.
<b>Interpup. distance:</b>	Adjustable between 51 and 75 mm.
<b>Dioptric adjustment:</b>	On both eyepieces.
<b>Eyepieces:</b>	WF10x/23 mm, high eye-point.
<b>Objective:</b>	Parfocal achromatic zoom 0.67x...4.5x (zoom factor 6.72:1) with click-stop detents.
<b>Working distance:</b>	110 mm

## SZO-1



Binocular stereomicroscope with pillar stand and ultra-flat base. In case illumination is needed, choose from the wide choice of external illuminators available.

**Observation mode:** Brightfield.

**Head:** Binocular, 45° inclined, 360° rotating.

**Interpupillary distance:** Adjustable between 51 and 75 mm.

**Dioptric adjustment:** On both eyepieces.

**Eyepieces:** WF10x/23 mm, high eye-point.

**Objective:** Parfocal achromatic zoom 0.67x...4.5x (zoom factor 6.72:1) with click-stop detents.

**Working distance:** 110 mm

**Specimen stage:** Fitted with a black/white disc, specimen clips and a diffusing disc for external light.

**Focusing:** Rack and pinion mechanism controlled by a pair of knobs placed on both sides of the stand.

**Stand:** Pillar stand 32 mm diameter and 315 mm high, base: 270x210x30h mm.

## SZO-2



Trinocular stereomicroscope with pillar stand and ultra-flat base. In case illumination is needed, choose from the wide choice of external illuminators available.

**Observation mode:** Brightfield.

**Head:** Trinocular (fixed photo port 70/30), 45° inclined, 360° rotating.

**Interpupillary distance:** Adjustable between 51 and 75 mm.

**Dioptric adjustment:** On both eyepieces.

**Eyepieces:** WF10x/23 mm, high eye-point.

**Objective:** Parfocal achromatic zoom 0.67x...4.5x (zoom factor 6.72:1) with click-stop detents.

**Working distance:** 110 mm

**Specimen stage:** Fitted with a black/white disc, specimen clips and a diffusing disc for external light.

**Focusing:** Rack and pinion mechanism controlled by a pair of knobs placed on both sides of the stand.

**Stand:** Pillar stand 32 mm diameter and 315 mm high, base: 270x210x30h mm.

## SZO-3



Binocular stereomicroscope with pillar stand and ultra-flat base, illuminated stage with **X-LED<sup>73</sup>** transmitted illumination and **X-LED<sup>3</sup>** incident illuminator for outstanding brightness, freely settable.

**Observation mode:** Brightfield.

**Head:** Binocular, 45° inclined, 360° rotating.

**Interpupillary distance:** Adjustable between 51 and 75 mm.

**Dioptric adjustment:** On both eyepieces.

**Eyepieces:** WF10x/23 mm, high eye-point.

**Objective:** Parfocal achromatic zoom 0.67x...4.5x (zoom factor 6.72:1) with click-stop detents.

**Working distance:** 110 mm

**Specimen stage:** Fitted with a diffusing disc for transmitted light, specimen clips and with a black/white disc.

**Focusing:** Rack and pinion mechanism controlled by a pair of knobs placed on both sides of the stand.

**Stand:** Pillar stand 32 mm diameter and 315 mm high, base: 270x210x30h mm.

**Illumination:** Double, adjustable incident and transmitted light with separated brightness controls and 6,300K color temperature:

**Incident illuminator:** **X-LED<sup>3</sup>** (single LED, 3.6W).

**Transmitted illuminator:** **X-LED<sup>73</sup>** (60 LEDs).

Multi-plug 100-240Vac/12Vdc external power supply.

## SZO-4



Trinocular stereomicroscope with pillar stand and ultra-flat base, illuminated stage with **X-LED<sup>73</sup>** transmitted illumination and **X-LED<sup>3</sup>** incident illuminator for outstanding brightness, freely settable.

**Observation mode:** Brightfield.

**Head:** Trinocular (fixed photo port 70/30), 45° inclined, 360° rotating.

**Interpupillary distance:** Adjustable between 51 and 75 mm.

**Dioptric adjustment:** On both eyepieces.

**Eyepieces:** WF10x/23 mm, high eye-point.

**Objective:** Parfocal achromatic zoom 0.67x...4.5x (zoom factor 6.72:1) with click-stop detents.

**Working distance:** 110 mm

**Specimen stage:** Fitted with a diffusing disc for transmitted light, specimen clips and with a black/white disc.

**Focusing:** Rack and pinion mechanism controlled by a pair of knobs placed on both sides of the stand.

**Stand:** Pillar stand 32 mm diameter and 315 mm high, base: 270x210x30h mm.

**Illumination:** Double, adjustable incident and transmitted light with separated brightness controls and 6,300K color temperature:

**Incident illuminator:** **X-LED<sup>3</sup>** (single LED, 3.6W).

**Transmitted illuminator:** **X-LED<sup>73</sup>** (60 LEDs).

Multi-plug 100-240Vac/12Vdc external power supply.



## SZO-5



Binocular stereomicroscope with pillar stand and ultra-flat base, illuminated stage with **X-LED<sup>3</sup>** transmitted illumination and **X-LED<sup>3</sup>** incident double arm light for outstanding brightness, freely settable.

**Observation mode:** Brightfield.

**Head:** Binocular, 45° inclined, 360° rotating.

**Interpupillary distance:** Adjustable between 51 and 75 mm.

**Dioptric adjustment:** On both eyepieces.

**Eyepieces:** WF10x/23 mm, high eye-point.

**Objective:** Parfocal achromatic zoom 0.67x...4.5x (zoom factor 6.72:1) with click-stop detents.

**Working distance:** 110 mm

**Specimen stage:** Fitted with a diffusing disc for transmitted light, specimen clips and with a black/white disc.

**Focusing:** Rack and pinion mechanism controlled by a pair of knobs placed on both sides of the stand.

**Stand:** Pillar stand 32 mm diameter and 315 mm high, base: 270x210x30h mm.

**Illumination:** Double, adjustable incident and transmitted light with separated brightness controls and 6,300K color temperature:

**Incident illuminator:** Two **X-LED<sup>3</sup>** (single LED, 3.6W) on flexible gooseneck. Illuminance: 170,000 lux (at 10 cm distance).

**Transmitted illuminator:** **X-LED<sup>3</sup>** (60 LEDs).  
Multi-plug 100-240Vac/12Vdc external power supply.

## SZO-6



Trinocular stereomicroscope with pillar stand and ultra-flat base, illuminated stage with **X-LED<sup>3</sup>** transmitted illumination and **X-LED<sup>3</sup>** incident double arm light for outstanding brightness, freely settable.

**Observation mode:** Brightfield.

**Head:** Trinocular (fixed photo port 70/30), 45° inclined, 360° rotating.

**Interpupillary distance:** Adjustable between 51 and 75 mm.

**Dioptric adjustment:** On both eyepieces.

**Eyepieces:** WF10x/23 mm, high eye-point.

**Objective:** Parfocal achromatic zoom 0.67x...4.5x (zoom factor 6.72:1) with click-stop detents.

**Working distance:** 110 mm

**Specimen stage:** Fitted with a diffusing disc for transmitted light, specimen clips and with a black/white disc.

**Focusing:** Rack and pinion mechanism controlled by a pair of knobs placed on both sides of the stand.

**Stand:** Pillar stand 32 mm diameter and 315 mm high, base: 270x210x30h mm.

**Illumination:** Double, adjustable incident and transmitted light with separated brightness controls and 6,300K color temperature:

**Incident illuminator:** Two **X-LED<sup>3</sup>** (single LED, 3.6W) on flexible gooseneck. Illuminance: 170,000 lux (at 10 cm distance).

**Transmitted illuminator:** **X-LED<sup>3</sup>** (60 LEDs).  
Multi-plug 100-240Vac/12Vdc external power supply.

# SZO Series - Range

## SZO-7

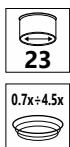

Binocular stereomicroscope with extremely stable overhanging stand complete of head holder and focusing system for perpendicular observation of particularly large specimens. Smooth horizontal and vertical movements are ensured. In case illumination is needed, choose from the wide choice of external illuminators available.

**Observation mode:** Brightfield.

**Head:** Binocular, 45° inclined, 360° rotating.

**Interpupillary distance:** Adjustable between 51 and 75 mm.

**Dioptric adjustment:** On both eyepieces.

**Eyepieces:** WF10x/23 mm, high eye-point.

**Objective:** Parfocal achromatic zoom 0.67x...4.5x (zoom factor 6.72:1) with click-stop detents.

**Working distance:** 110 mm

**Focusing:** Rack and pinion mechanism controlled by a pair of knobs placed on both sides of the stand.

**Stand:** Overhanging stand 420 mm high, 430 mm horizontal arm length, base 230x230 mm with following adjustments: height, longitudinal extension and head rotation angle (left-right).

## SZO-8

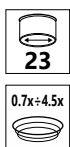

Trinocular stereomicroscope with extremely stable overhanging stand complete of head holder and focusing system for perpendicular observation of particularly large specimens. Smooth horizontal and vertical movements are ensured. In case illumination is needed, choose from the wide choice of external illuminators available.

**Observation mode:** Brightfield.

**Head:** Trinocular (fixed photo port 70/30), 45° inclined, 360° rotating.

**Interpupillary distance:** Adjustable between 51 and 75 mm.

**Dioptric adjustment:** On both eyepieces.

**Eyepieces:** WF10x/23 mm, high eye-point.

**Objective:** Parfocal achromatic zoom 0.67x...4.5x (zoom factor 6.72:1) with click-stop detents.

**Working distance:** 110 mm

**Specimen stage:** Fitted with a black/white disc and specimen clips

**Focusing:** Rack and pinion mechanism controlled by a pair of knobs placed on both sides of the stand.

**Stand:** Overhanging stand 420 mm high, 430 mm horizontal arm length, base 230x230 mm with following adjustments: height, longitudinal extension and head rotation angle (left-right).

# SZO Series - Range

## SZO-9

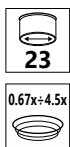

Binocular stereomicroscope with extremely stable, hinged and long overhanging stand complete of head holder and focusing system for observation of particularly large specimens. The head can be easily tilted for inspection at oblique angles ideal e.g. for stone setters. Smooth horizontal and vertical movement are ensured. In case illumination is needed, choose from the wide choice of external illuminators available.

**Observation mode:** Brightfield.

**Head:** Binocular, 45° inclined, 360° rotating.

**Interpupillary distance:** Adjustable between 51 and 75 mm.

**Dioptric adjustment:** On both eyepieces.

**Eyepieces:** WF10x/23 mm, high eye-point.

**Objective:** Parfocal achromatic zoom 0.67x..4.5x (zoom factor 6.72:1) with click-stop detents.

**Working distance:** 110 mm

**Focusing:** Rack and pinion mechanism controlled by a pair of knobs placed on both sides of the stand.

**Stand:** Overhanging stand 420 mm high, 550 mm horizontal arm length, base 260x210 mm with following adjustments: height, longitudinal extension and head rotation angle (left-right) and head inclination angle.

## SZO-10

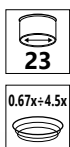

Binocular stereomicroscope with extremely stable, hinged and long overhanging stand complete of head holder and focusing system for observation of particularly large specimens. The head can be easily tilted for inspection at oblique angles ideal e.g. for stone setters. Smooth horizontal and vertical movement are ensured. In case illumination is needed, choose from the wide choice of external illuminators available.

**Observation mode:** Brightfield.

**Head:** Trinocular (fixed photo port 70/30), 45° inclined, 360° rotating.

**Interpupillary distance:** Adjustable between 51 and 75 mm.

**Dioptric adjustment:** On both eyepieces.

**Eyepieces:** WF10x/23 mm, high eye-point.

**Objective:** Parfocal achromatic zoom 0.67x..4.5x (zoom factor 6.72:1) with click-stop detents.

**Working distance:** 110 mm

**Focusing:** Rack and pinion mechanism controlled by a pair of knobs placed on both sides of the stand.

**Stand:** Overhanging stand 420 mm high, 550 mm horizontal arm length, base 260x210 mm with following adjustments: height, longitudinal extension and head rotation angle (left-right) and head inclination angle.

# 3 SZO Series - Optical System



## SZO Series - Optical Performance

Eyepiece	10x (ST-301)		15x (ST-302)		20x (ST-303)		25x (ST-144)	
Field number (mm)	23		16		12		9	
Objective	Total magnification	Field of View (mm)	Total magnification	Field of View (mm)	Total magnification	Field of View (mm)	Total magnification	Field of View (mm)
0.3x (W.D: 287 mm)	2.01x-13.5x	114.43-17.04	3.02x-20.25x	79.60-11.85	4.02x-27x	59.70-8.89	5.025x-33.75x	44.78-6.67
0.5x (W.D: 177 mm)	3.35x-22.5x	68.66-10.22	5.02x-33.75x	47.76-7.11	6.7x-45x	35.82-5.33	8.375x-56.25x	26.87-4.00
0.75x (W.D: 120 mm)	5.02x-33.75x	45.77-6.81	7.54x-50.63x	31.84-4.74	10.05x-67.5x	23.88-3.56	12.5625x-84.375x	17.91-2.67
1x (W.D: 110 mm)	6.7x-45x	34.33-5.11	10.05x-67.50x	23.88-3.56	13.4x-90x	17.91-2.67	16.75x-112.5x	13.43-2.00
1.5x (W.D: 47 mm)	10.05x-67.5x	22.89-3.41	15.08x-101.25	15.92-2.37	20.1x-135x	11.94-1.78	25.125x-168.75x	8.96-1.33
2x (W.D: 26 mm)	13.4x-90x	17.16-2.56	20.10x-135.00x	11.94-1.78	26.8x-180x	8.96-1.33	33.5x-225x	6.72-1.00

# SZO Series - Comparison Chart

Model	Head	Eyepiece	Objectives	Working Distance	Stand	Illumination
<b>SZO-1</b>	Binocular, 360° rotating, 45° inclined	Extra Wide Field 10x/23, high eye-point	0.67....4.5x	110mm	Pillar stand with rack and pinion system	Without illumination; External light source needed
<b>SZO-2</b>	Trinocular, 360° rotating, 45° inclined	Extra Wide Field 10x/23, high eye-point	0.67....4.5x	110mm	Pillar stand with rack and pinion system	Without illumination; External light source needed
<b>SZO-3</b>	Binocular, 360° rotating, 45° inclined	Extra Wide Field 10x/23, high eye-point	0.67....4.5x	110mm	Pillar stand with rack and pinion system	Transmitted: OPTIKA X-LED <sup>3</sup> , 100 mm LED disc (60 LEDs). Incident: OPTIKA X-LED <sup>3</sup> . With separated brightness controls
<b>SZO-4</b>	Trinocular, 360° rotating, 45° inclined	Extra Wide Field 10x/23, high eye-point	0.67....4.5x	110mm	Pillar stand with rack and pinion system	Transmitted: OPTIKA X-LED <sup>3</sup> , 100 mm LED disc (60 LEDs). Incident: OPTIKA X-LED <sup>3</sup> . With separated brightness controls
<b>SZO-5</b>	Binocular, 360° rotating, 45° inclined	Extra Wide Field 10x/23, high eye-point	0.67....4.5x	110mm	Pillar with rack and pinion system	Transmitted: OPTIKA X-LED <sup>3</sup> , 100 mm LED disc (60 LEDs). Incident: double arm OPTIKA X-LED <sup>3</sup> . With separated brightness controls
<b>SZO-6</b>	Trinocular, 360° rotating, 45° inclined	Extra Wide Field 10x/23, high eye-point	0.67....4.5x	110mm	Pillar with rack and pinion system	Transmitted: OPTIKA X-LED <sup>3</sup> , 100 mm LED disc (60 LEDs). Incident: double arm OPTIKA X-LED <sup>3</sup> . With separated brightness controls
<b>SZO-7</b>	Binocular, 360° rotating, 45° inclined	Extra Wide Field 10x/23, high eye-point	0.67....4.5x	110mm	Simple overhanging stand	Without illumination; External light source needed
<b>SZO-8</b>	Trinocular, 360° rotating, 45° inclined	Extra Wide Field 10x/23, high eye-point	0.67....4.5x	110mm	Simple overhanging stand	Without illumination; External light source needed
<b>SZO-9</b>	Binocular, 360° rotating, 45° inclined	Extra Wide Field 10x/23, high eye-point	0.67....4.5x	110mm	Hinged overhanging stand	Without illumination; External light source needed
<b>SZO-10</b>	Trinocular, 360° rotating, 45° inclined	Extra Wide Field 10x/23, high eye-point	0.67....4.5x	110mm	Hinged overhanging stand	Without illumination; External light source needed



# 3 SZO Series - Accessories

## Eyecups & Eyepieces

- ST-144 WF25x/9 eyepieces (pair), high eyepoint, focusable, with rubber cup
- ST-301 WF10x/23 eyepieces (pair), high eyepoint, focusable, with rubber cup
- ST-302 WF15x/16 eyepieces (pair), high eyepoint, focusable, with rubber cup
- ST-303 WF20x/12 eyepieces (pair), high eyepoint, focusable, with rubber cup
- ST-305 WF10x/23 micrometric eyepiece, high eyepoint, focusable, rubber cup

## Objectives & Additional Lenses

- ST-102 Additional lens 0.3x (w.d. 287mm)
- ST-103 Additional lens 0.5x (w.d. 177mm)
- ST-104 Additional lens 0.75x (w.d. 120mm)
- ST-105 Additional lens 1.5x (w.d. 47mm)
- ST-106 Additional lens 2x (w.d. 26mm)

## Stages

- ST-100.1 Hand moving stage, 100mm diameter
- ST-110.1 Moving stage, coaxial knobs, 100mm diameter
- ST-111.1 Moving stage, micrometric screws, 100mm diameter
- ST-666.1-EU Applicable heating stage (stereomicroscopes, 100mm diameter), EU
- ST-666.1-UK Applicable heating stage (stereomicroscopes, 100mm diameter), UK
- ST-666.1-US Applicable heating stage (stereomicroscopes, 100mm diameter), US
- ST-666.1-SW Applicable heating stage (stereomicroscopes, 100mm diameter), CH

## Condenser & Filters

- ST-040.1 Darkfield condenser, 100mm diameter
- ST-088.1 Polarising set (filters and rotating stage), 100mm diameter

## Camera Adapters

- M-113.1 Ring adapter, 30mm (for monocular and binocular microscopes)
- M-115 0.35x C-Mount projection lens
- M-114 0.5x C-Mount projection lens
- M-118 0.75x C-Mount projection lens
- M-173 C-Mount projection lens for APS-C/full frame reflex cameras (trino)
- M-699 Universal adapter for C-Mount projection lens (trino)
- ST-090 0.35x focusable C-Mount adapter (stereomicroscopes)
- ST-090.1 0.5x focusable C-Mount adapter (stereomicroscopes)
- ST-090.2 0.65x focusable C-Mount adapter (stereomicroscopes)
- M-620.3 1x focusable C-Mount adapter (biological & stereomicroscopes)

## Miscellaneous

- 15104 Cleaning kit
- DC-002 Plastic dust cover, medium, 490(l)x490(h) mm
- DC-003 TNT dust cover, medium, 600(l)x550(h) mm
- DC-004 TNT dust cover, large, 700(l)x550(h) mm
- M-005 Micrometric slide, 26x76mm, with 2 scales (1mm/100 & 10mm/100)
- ST-041 Sample clip
- ST-042 White/black object-plate, 100mm diameter
- ST-043 Glass object-plate, 100mm diameter
- ST-092 Protective glass for stereohead
- VP-SZ IQ/OQ/PQ manual for SZ series

### 15104 - Lens cleaner, 50ml

It cleans glass quickly and effectively, without leaving residue or odor. Ideal for precision lens or prism cleaning.



#### How to connect the cameras to our microscopes.

Please refer to the Adapter reference list on Digital section.

v 1.4.0 - OPTIKA reserves the right to make corrections, modifications, enhancements, improvements and other changes to its products at any time without notice.

## Headquarters and Manufacturing Facilities

**OPTIKA® S.r.l.** Via Rigla, 30 - 24010 Ponteranica (BG) - ITALY - Tel.: +39 035.571.392 - info@optikamicroscopes.com

## Optika Sales branches

**OPTIKA® Spain** spain@optikamicroscopes.com  
**OPTIKA® China** china@optikamicroscopes.com  
**OPTIKA® India** india@optikamicroscopes.com

**OPTIKA® USA** usa@optikamicroscopes.com  
**OPTIKA® Central America** camerica@optikamicroscopes.com

# MODULAR Series



**Advanced Modular Stereozoom Microscopes**



## Modular Series

### Identify The Most Suitable Heads For Your Needs

OPTIKA provides three series of stereomicroscope heads based on different field number, zoom level (and consequently, zoom ratio), inclination, and working distance.

An even more substantial differentiating element is also the optical system: choose between Greenough or Galilean.

### Multiple Mounting Stands and Configurations

An extremely wide stand selection gives you the chance to create your tailored stereomicroscope! Choose among the several models available to virtually cover every customers' needs, in terms of illumination, arm extension, and focusing system.





# Modular Stereozoom Microscopes

## Overhanging Stand, In Case Of Large Samples

This stand is recommended for efficient, quick and precise observation and digital imaging of large samples, that cannot be processed with regular stands. Achieve 360° rotation and smooth movement with no limits, as the mechanism can be tilted from right to left, backward to forward.

ST-172

## Get the most out of our accessories

### ST-172 - Iris diaphragm module

With this accessory, the depth of field of the final image can be adjusted, for applications where different planes all in focus are needed.



**OUT-OF-FOCUS AREA**

With iris diaphragm open

**FOCUS PLANE**



**IN-FOCUS AREA**

With iris diaphragm close

Soldered Led Pin - SZP-8 with iris diaphragm module and ST-156 stand.



# Modular Series

## Applications

Some application examples demonstrating the versatility of stereomicroscopes with SZM, SZO and SZP heads. Applications in industrial and research are extremely facilitated by the advanced functionality offered.

## Legend

1. Matrix LED adjustable incident illuminator on ST-156.
2. SZ-STL2H overhanging stand, SZO-T head and CL-41 flexible arm LED illuminator.
3. Sample of copper-brass weld interface.
4. CL-16.1 LED ring illuminator.
5. Oblique illumination using a CLD-01 cold light generator.
6. Inspection of a steel blade.
7. Applications in electronics manufacturing.
8. CLD-01 LED illuminator with CL-11.1 double-arm optical fiber guide.

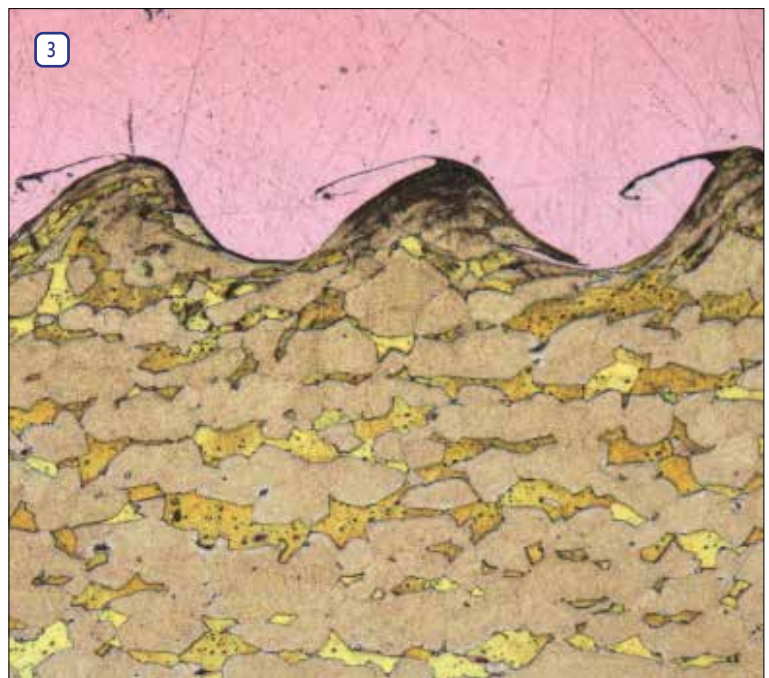
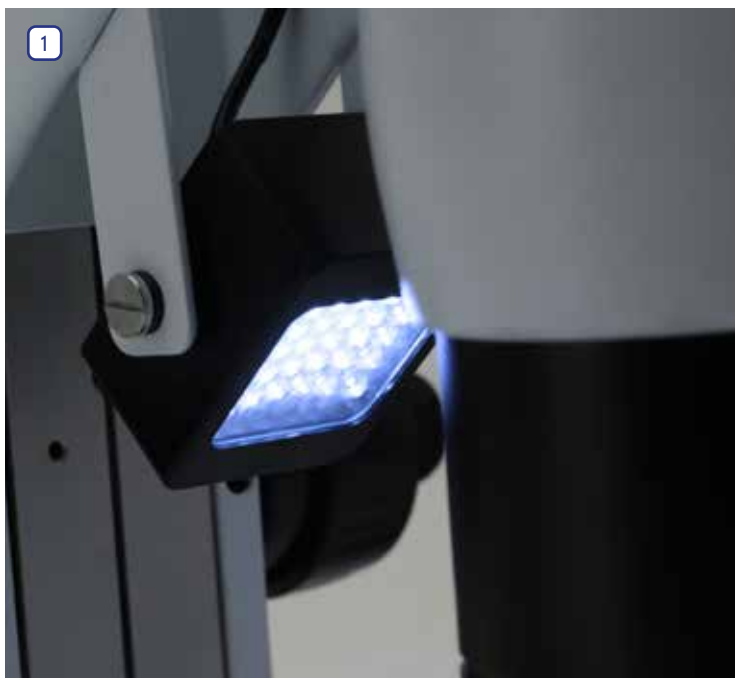

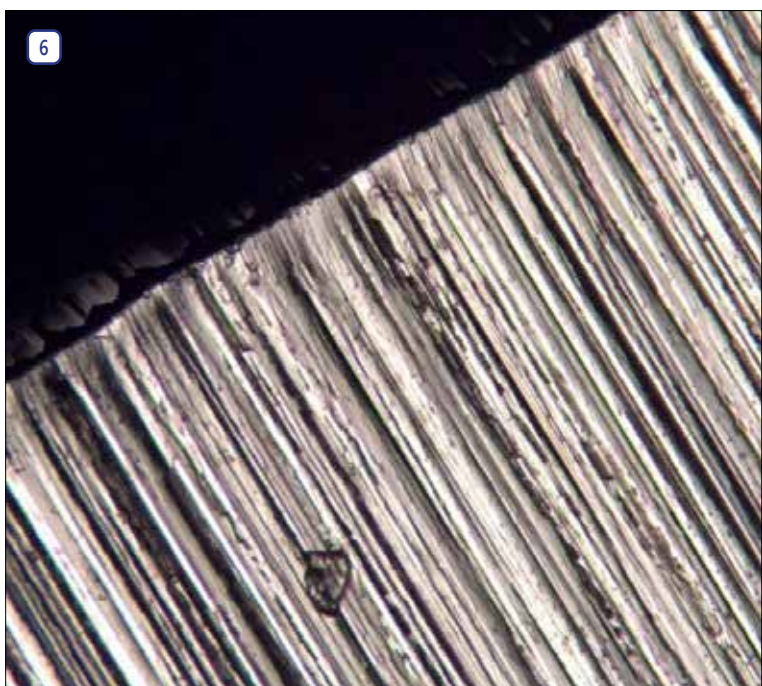
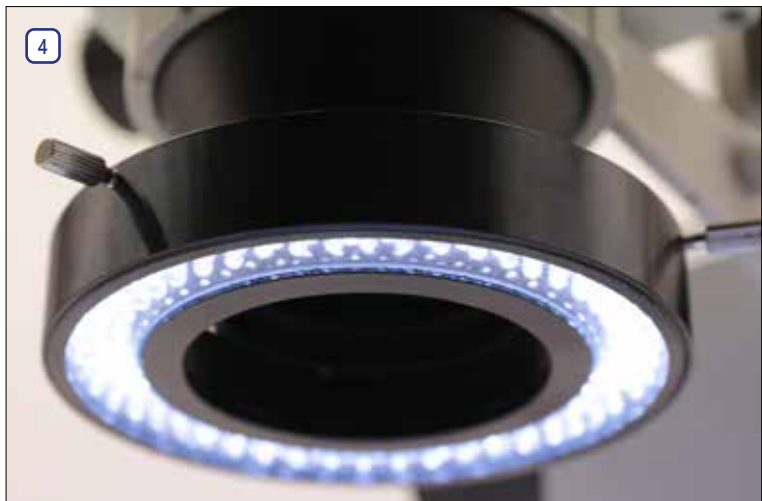

# MODULAR Series - Heads

OPTIKA provides three series of stereomicroscope heads based on different field number, zoom level (and consequently, zoom ratio), inclination, and working distance. An even more substantial differentiating element is also the optical system: choose between Greenough or Galilean, according to the application.



## SZM-B

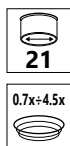

Part	Description
<b>Head:</b>	Binocular, 360° rotating on all stands and 45° inclined.
<b>Interpup. distance:</b>	Adjustable between 51 and 75 mm.
<b>Dioptric adjustment:</b>	On both eyepiece tubes.
<b>Eyepieces:</b>	WF10x/21 mm, high eye-point.
<b>Objective:</b>	Parfocal achromatic zoom 0.7x...4.5x (zoom factor 6.43:1).
<b>Working distance:</b>	100 mm
<b>Optical system:</b>	Greenough (15° inclined)

## SZM-T

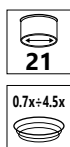

Part	Description
<b>Head:</b>	Trinocular, 360° rotating on all stands and 45° inclined. 2-position photo port: 100/0 and 0/100 (on right eyepiece tube).
<b>Interpup. distance:</b>	Adjustable between 51 and 75 mm.
<b>Dioptric adjustment:</b>	On both eyepiece tubes.
<b>Eyepieces:</b>	WF10x/21 mm, high eye-point.
<b>Objective:</b>	Parfocal achromatic zoom 0.7x...4.5x (zoom factor 6.43:1).
<b>Working distance:</b>	100 mm
<b>Optical system:</b>	Greenough (15° inclined)

# MODULAR Series - Heads

## SZO-B



Part	Description
<b>Head:</b>	Binocular, 360° rotating on all stands and 45° inclined.
<b>Interpup. distance:</b>	Adjustable between 51 and 75 mm.
<b>Dioptric adjustment:</b>	On both eyepieces.
<b>Eyepieces:</b>	WF10x/23 mm, high eye-point.
<b>Objective:</b>	Parfocal achromatic zoom 0.67x...4.5x (zoom factor 6.72:1) with click-stop detents.
<b>Working distance:</b>	110 mm
<b>Optical system:</b>	Greenough (15° inclined)

## SZO-T



Part	Description
<b>Head:</b>	Trinocular (fixed photo port 70/30), 360° rotating on all stands and 45° inclined.
<b>Interpup. distance:</b>	Adjustable between 51 and 75 mm.
<b>Dioptric adjustment:</b>	On both eyepieces.
<b>Eyepieces:</b>	WF10x/23 mm, high eye-point.
<b>Objective:</b>	Parfocal achromatic zoom 0.67x...4.5x (zoom factor 6.72:1) with click-stop detents.
<b>Working distance:</b>	110 mm
<b>Optical system:</b>	Greenough (15° inclined)

# MODULAR Series - Heads

## SZP-6, SZP-8, SZP-10



Part	Description
<b>Head:</b>	Binocular, 360° rotating on all stands and 30° inclined.
<b>Interpup. distance:</b>	Adjustable between 52 and 75 mm.
<b>Dioptric adjustment:</b>	On both eyepieces.
<b>Eyepieces:</b>	WF10x/24 mm, high eye-point.
<b>SZP-6 zoom body:</b>	Parfocal achromatic zoom 0.8x...5.0x (zoom factor 6.25:1).
<b>SZP-8 zoom body:</b>	Parfocal achromatic zoom 0.8x...6.4x (zoom factor 8:1).
<b>SZP-10 zoom body:</b>	Parfocal achromatic zoom 0.8x...8.0x (zoom factor 10:1).
<b>Objective lens:</b>	Plan Achromatic 1x.
<b>Working distance:</b>	80 mm.
<b>Optical system:</b>	Galilean (Parallel, infinity corrected).



## SZP-6e, SZP-8e, SZP-10e



Part	Description
<b>Head:</b>	Ergonomical binocular, 360° rotating on all stands and freely inclinable from 0° to 35°.
<b>Interpup. distance:</b>	Adjustable between 55 and 80 mm.
<b>Dioptric adjustment:</b>	On both eyepieces.
<b>Eyepieces:</b>	WF10x/24 mm, high eye-point.
<b>SZP-6e zoom body:</b>	Parfocal achromatic zoom 0.8x...5.0x (zoom factor 6.25:1).
<b>SZP-8e zoom body:</b>	Parfocal achromatic zoom 0.8x...6.4x (zoom factor 8:1).
<b>SZP-10e zoom body:</b>	Parfocal achromatic zoom 0.8x...8.0x (zoom factor 10:1).
<b>Objective lens:</b>	Plan Achromatic 1x.
<b>Working distance:</b>	80 mm.
<b>Optical system:</b>	Galilean (Parallel, infinity corrected).



# MODULAR Series - Optical Performance

## SZM Heads

Eyepiece	10x (ST-081)		15x (ST-082)		20x (ST-083)	
Field number (mm)	21		15		10	
Objective	Total magnification	Field of View (mm)	Total magnification	Field of View (mm)	Total magnification	Field of View (mm)
0.5x (W.D. 165 mm)	3.5x-22.5x	60.00-9.23	5.25x-33.75x	42.86-6.67	7x-45x	28.57-4.44
0.75x (W.D. 117 mm)	5.25x-33.75x	40.00-6.22	7.875x-50.625x	28.57-4.44	10.50x-67.5x	19.05-2.96
1x (W.D. 100 mm)	7x-45x	30.00-4.66	10.5x-67.5x	21.43-3.33	14x-90x	14.29-2.22
1.5x (W.D. 47 mm)	10.50x-67.5x	20.00-3.11	15.75x-101.25x	14.29-2.22	21x-135x	9.52-1.48
2x (W.D. 33 mm)	14x-90x	15.00-2.33	21x-135x	10.71-1.67	28x-180x	7.14-1.11

## SZO Heads

Eyepiece	10x (ST-301)		15x (ST-302)		20x (ST-303)		25x (ST-144)	
Field number (mm)	23		16		12		9	
Objective	Total magnification	Field of View (mm)	Total magnification	Field of View (mm)	Total magnification	Field of View (mm)	Total magnification	Field of View (mm)
0.3x (W.D: 287 mm)	2.01x-13.5x	114.43-17.04	3.02x-20.25x	79.60-11.85	4.02x-27x	59.70-8.89	5.025x-33.75x	44.78-6.67
0.5x (W.D: 177 mm)	3.35x-22.5x	68.66-10.22	5.02x-33.75x	47.76-7.11	6.7x-45x	35.82-5.33	8.375x-56.25x	26.87-4.00
0.75x (W.D: 120 mm)	5.02x-33.75x	45.77-6.81	7.54x-50.63x	31.84-4.74	10.05x-67.5x	23.88-3.56	12.5625x-84.375x	17.91-2.67
1x (W.D: 110 mm)	6.7x-45x	34.33-5.11	10.05x-67.50x	23.88-3.56	13.4x-90x	17.91-2.67	16.75x-112.5x	13.43-2.00
1.5x (W.D: 47 mm)	10.05x-67.5x	22.89-3.41	15.08x-101.25	15.92-2.37	20.1x-135x	11.94-1.78	25.125x-168.75x	8.96-1.33
2x (W.D: 26 mm)	13.4x-90x	17.16-2.56	20.10x-135.00x	11.94-1.78	26.8x-180x	8.96-1.33	33.5x-225x	6.72-1.00

## SZP Heads

### Optical performance SZP-6 / SZP-6e

Eyepiece	10x (ST-160)		15x (ST-161)		20x (ST-162)	
Field number (mm)	24		15		10	
Objective	Total magnification	Field of View (mm)	Total magnification	Field of View (mm)	Total magnification	Field of View (mm)
0.3x (W.D: 280 mm)	2.4x-15x	100.00-16.00	3.6x-22.5x	62.50-10.00	4.8x-30x	41.67-6.67
0.5x (W.D: 165 mm)	4x-25x	60.00-9.60	6x-37.5x	37.50-6.00	8x-50x	25.00-4.00
1x (W.D: 80 mm)	8x-50x	30-4.80	12x-75x	18.75-3.00	16x-100x	12.50-2.00
2x (W.D: 32.5 mm)	16x-100x	15-2.40	24x-150x	9.38-1.50	32x-200x	6.25-1.00

### Optical performance SZP-8 / SZP-8e

Eyepiece	10x (ST-160)		15x (ST-161)		20x (ST-162)	
Field number (mm)	24		15		10	
Objective	Total magnification	Field of View (mm)	Total magnification	Field of View (mm)	Total magnification	Field of View (mm)
0.3x (W.D: 280 mm)	2.4x-19.2x	100.00-12.50	3.6x-28.8x	62.50-7.81	4.8x-38.4x	41.67-5.21
0.5x (W.D: 165 mm)	4x-32x	60.00-7.50	6x-48x	37.50-4.69	8x-64x	25.00-3.13
1x (W.D: 80 mm)	8x-64x	30.00-3.75	12x-96x	18.75-2.34	16x-128x	12.50-1.56
2x (W.D: 32.5 mm)	16x-128x	15.00-1.88	24x-192x	9.38-1.17	32x-256x	6.25-0.78

### Optical performance SZP-10 / SZP-10e

Eyepiece	10x (ST-160)		15x (ST-161)		20x (ST-162)	
Field number (mm)	24		15		10	
Objective	Total magnification	Field of View (mm)	Total magnification	Field of View (mm)	Total magnification	Field of View (mm)
0.3x (W.D: 280 mm)	2.4x-24x	100.00-10.00	3.6x-36x	62.50-6.25	4.8x-48x	41.67-4.17
0.5x (W.D: 165 mm)	4x-40x	60.00-6.00	6x-60x	37.50-3.75	8x-80x	25.00-2.50
1x (W.D: 80 mm)	8x-80x	30.00-3.00	12x-120x	18.75-1.88	16x-160x	12.50-1.25
2x (W.D: 32.5 mm)	16x-160x	15.00-1.50	24x-240x	9.38-0.94	32x-320x	6.25-0.63



# MODULAR Series - Accessories for Heads

## ACCESSORIES FOR SZM HEADS

### Eyecups & Eyepieces

ST-036	Eyecups (pair), curved
ST-081	WF10x/21 eyepieces (pair), high eyepoint, with rubber cup
ST-082	WF15x/15 eyepieces (pair), high eyepoint
ST-083	WF20x/10 eyepieces (pair), high eyepoint
ST-084	WF10x/21 micrometric eyepiece, high eyepoint, with rubber cup

### Objectives & Additional Lenses

ST-091	Additional lens 0.75x (w.d. 105mm)
ST-087	Additional lens 2x (w.d. 33mm)

### Camera Adapters

M-113.1	Ring adapter, 30mm (for monocular and binocular microscopes)
M-115	0.35x C-Mount projection lens
M-114	0.5x C-Mount projection lens
M-118	0.75x C-Mount projection lens
M-173	C-Mount projection lens for APS-C/full frame reflex cameras (trino)
M-699	Universal adapter for C-Mount projection lens (trino)
ST-090	0.35x focusable C-Mount adapter (stereomicroscopes)
ST-090.1	0.5x focusable C-Mount adapter (stereomicroscopes)
ST-090.2	0.65x focusable C-Mount adapter (stereomicroscopes)
M-620.3	1x focusable C-Mount adapter (biological & stereomicroscopes)

### Miscellaneous

15104	Cleaning kit
DC-002	Plastic dust cover, medium, 490(l)x490(h) mm
M-005	Micrometric slide, 26x76mm, with 2 scales (1mm/100 & 10mm/100)
ST-092	Protective glass for stereohead
VP-SZM	IQ/OQ/PQ manual for SZM series

## ACCESSORIES FOR SZO HEADS

### Eyecups & Eyepieces

ST-144	WF25x/9 eyepieces (pair), high eyepoint, focusable, with rubber cup
ST-301	WF10x/23 eyepieces (pair), high eyepoint, focusable, with rubber cup
ST-302	WF15x/16 eyepieces (pair), high eyepoint, focusable, with rubber cup
ST-303	WF20x/12 eyepieces (pair), high eyepoint, focusable, with rubber cup
ST-305	WF10x/23 micrometric eyepiece, high eyepoint, focusable, rubber cup

### Objectives & Additional Lenses

ST-102	Additional lens 0.3x (w.d. 287mm)
ST-103	Additional lens 0.5x (w.d. 177mm)
ST-104	Additional lens 0.75x (w.d. 120mm)
ST-105	Additional lens 1.5x (w.d. 47mm)
ST-106	Additional lens 2x (w.d. 26mm)
SZ-EXT	Spacer for negative additional lenses

### Camera Adapters

M-113.1	Ring adapter, 30mm (for monocular and binocular microscopes)
M-115	0.35x C-Mount projection lens
M-114	0.5x C-Mount projection lens
M-118	0.75x C-Mount projection lens
M-173	C-Mount projection lens for APS-C/full frame reflex cameras (trino)
M-699	Universal adapter for C-Mount projection lens (trino)
ST-090	0.35x focusable C-Mount adapter (stereomicroscopes)
ST-090.1	0.5x focusable C-Mount adapter (stereomicroscopes)
ST-090.2	0.65x focusable C-Mount adapter (stereomicroscopes)
M-620.3	1x focusable C-Mount adapter (biological & stereomicroscopes)

### Miscellaneous

15104	Cleaning kit
DC-002	Plastic dust cover, medium, 490(l)x490(h) mm
DC-004	TNT dust cover, large, 700(l)x550(h) mm
M-005	Micrometric slide, 26x76mm, with 2 scales (1mm/100 & 10mm/100)
ST-092	Protective glass for stereohead
VP-SZ	IQ/OQ/PQ manual for SZ series

## ACCESSORIES FOR SZP HEADS

### Eyecups & Eyepieces

ST-160	WF10x/24 eyepiece, high eyepoint, focusable, with rubber cup
ST-161	WF15x/16 eyepieces (pair), focusable, with rubber cup
ST-162	WF20x/12 eyepieces (pair), focusable, with rubber cup
ST-163	WF10x/24 micrometric eyepiece, high eyepoint, focusable, rubber cup

### Objectives & Additional Lenses

ST-165	0.3x objective (w.d. 280mm)
ST-166	0.5x objective (w.d. 118mm)
ST-167	2x objective (w.d. 32.5mm)

### Camera Adapters

M-113.1	Ring adapter, 30mm (for monocular and binocular microscopes)
M-115	0.35x C-Mount projection lens
M-114	0.5x C-Mount projection lens
M-118	0.75x C-Mount projection lens
M-173	C-Mount projection lens for APS-C/full frame reflex cameras (trino)
M-699	Universal adapter for C-Mount projection lens (trino)
ST-090	0.35x focusable C-Mount adapter (stereomicroscopes)
ST-090.1	0.5x focusable C-Mount adapter (stereomicroscopes)
ST-090.2	0.65x focusable C-Mount adapter (stereomicroscopes)
M-620.3	1x focusable C-Mount adapter (biological & stereomicroscopes)

### Miscellaneous

15104	Cleaning kit
DC-002	Plastic dust cover, medium, 490(l)x490(h) mm
M-005	Micrometric slide, 26x76mm, with 2 scales (1mm/100 & 10mm/100)
M-151	HBO 100W high-pressure mercury bulb for fluorescence
ST-098	Polarising set (filters and rotating stage - specify stand diameter)
ST-170	Photo/Video beam splitter - 1 port
ST-171	Photo/Video beam splitter - 2 port
ST-172	Iris diaphragm module
ST-176	Protective glass for stereohead
SZP-FL-EU	HBO fluo attachment, 3-pos. (B & G filter set), EU
SZP-FL-UK	HBO fluo attachment, 3-pos. (B & G filter set), UK
SZP-FL-US	HBO fluo attachment, 3-pos. (B & G filter set), US
SZP-FL-SW	HBO fluo attachment, 3-pos. (B & G filter set), CH
VP-SZP	IQ/OQ/PQ manual for SZP series



ST-172



ST-170



ST-171

# MODULAR Series - Stands

An extremely wide stand selection gives you the chance to create your tailored stereomicroscope! Choose among the several models available to virtually cover every customers' needs, in terms of illumination, arm extension, and focusing system.



**SZ-STLX**

**ST-150**

**ST-151**

**SZ-STL5LED**

**ST-152**

**SZ-STL5**

**ST-153**

**SZ-STL2H**

**ST-155**

**SZ-STL1H**

**ST-156**

**SZ-STL8**

## ST-150

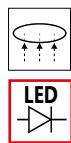

Large, simple plain stand with head holder and focusing mechanism. **Pillar type.**

Base size: 320x290 mm. Pillar size: Ø32x360 mm.

## ST-151



Large plain stand with **LED transmitted illumination** and adjustable intensity control, head holder and focusing mechanism. **Pillar type.**

Base size: 320x290 mm. Pillar size: Ø32x360 mm.

## ST-152

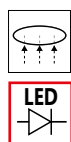

Large, simple plain stand with head holder and focusing mechanism. **Fixed arm type.**

Base size: 320x280 mm. Fixed arm height: 360 mm.

## ST-153



Large plain stand with **LED transmitted illumination**, and adjustable intensity control, head holder and focusing mechanism. **Fixed arm type.**

Base size: 320x290 mm. Fixed arm height: 360 mm.

# 3 MODULAR Series - Stands

## ST-155



ST-155 with SZP-8 head

Modern, large plain stand equipped with **LED transmitted and incident illumination**, both with **intensity control**. It comes complete of head holder and focusing mechanism.  
 Base size: 330x290 mm. Height: 40 mm. Fixed arm height: 340 mm.  
 Head not included.

## ST-156

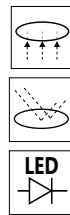

ST-156 with -8 head

Modern, large plain stand equipped with **LED transmitted and incident illumination**, both with **intensity control**. It comes complete of head holder and **coaxial coarse and fine focusing system**. Base size: 330x290 mm. Height: 40 mm.  
 Fixed arm height: 340 mm. Head not included.

## SZ-STL8

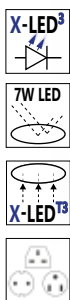

### X-LED<sup>3</sup>: 60-LED illuminator for transmitted light

Modern stand equipped with the **exclusive X-LED<sup>3</sup> lighting system** located in two flexible arms and extra-large **settable X-LED<sup>3</sup> transmitted illumination** for enhanced brightness and improved sample observation.  
**Incident illuminator:** Two X-LED3 (single LED, 3.6W) on flexible gooseneck. Illuminance: 170,000 lux (at 10 cm distance).  
**Transmitted illuminator:** X-LED<sup>3</sup> (60 LEDs).  
 Base size: 270x210 mm. Height: 30 mm. Pillar: Ø32x315 mm.  
 Multi-plug 100-240Vac/12Vdc external power supply.

## SZ-STL1H



Extremely stable overhanging stand **complete of head holder and focusing system** for perpendicular observation of particularly large specimens. **Smooth horizontal and vertical movements** are ensured. In case illumination is needed, choose from the wide choice of **external illuminators** available.

Base dimensions: 230x230 mm.  
Pillar: Ø32x420 mm.  
Horizontal arm: 430 mm.

## SZ-STL2H



Extremely stable, hinged and long overhanging stand complete of head holder and focusing system for observation of particularly large specimens. The head can be easily tilted for inspection at **oblique angles** ideal e.g. for stone setters. **Smooth horizontal and vertical movement** are ensured. In case illumination is needed, choose from the wide choice of **external illuminators** available.

Base dimensions: 255x210 mm.  
Pillar: Ø32x420 mm.  
Horizontal arm: 670 mm.

# MODULAR Series - Stands

## SZ-STL5



SZ-STL5L with SZO-T head



**Wall mount & table clamp, both included**

**Highly versatile flexible arm** stand, 360°rotating, ideal for industrial applications. It comes complete of **head holder with focusing system** and all the supports for **table clamp and wall mount**. **Small footprint** is ensured when not in use, saving valuable space on the bench. Head not included.

## SZ-STL5LED



**Mechanical component SZ-STL5LED and SZM-T**



SZ-STL5LED with SZP-8 head

**Highly versatile flexible arm** stand, 360°rotating, ideal for industrial applications. It comes complete of the settable and **exclusive X-LED<sup>3</sup> incident illumination system**, head holder with focusing system and all the supports for **table clamp and wall mount**. **Small footprint** is ensured when not in use, saving valuable space on the bench. Head not included. Multi-plug 100-240Vac/6Vdc external power supply.

## SZ-STLX



Extremely stable, long overhanging stand complete of head holder and focusing system for observation of particularly large specimens. The head can be easily **swivelled** and **tilted** for inspection at **oblique angles**. **Smooth horizontal and vertical movements** are ensured. In case illumination is needed, choose from the wide choice of **external illuminators** available.

Base dimensions: 210×255 mm.  
Pillar: Ø32×425 mm.  
Horizontal arm: 790 mm (movement range 330 mm).  
Swivel: 360°  
Tilt: 180°  
Weight: 16.25 kg  
Head not included.

SZ-STLX with SZN-B head



SZ-STLX with SZ0-B head and CLD-01 + CL11.1

# MODULAR Series - Accessories

Most of the time, it is of fundamental importance to combine a stereomicroscope with the right accessories, such as attachments, illuminators, and moving or heating stages are necessary for some specific applications.





# SZP-FL - Epi-Fluorescence Attachment

**Attachment for fluorescence applications for SZP stereomicroscopes only.**

Used in many applications like biology, botany, electronics, materials, forensics. Equipped with HBO 100W mercury lamp illuminator.  
To be combined with ST-150 or ST-151 stand.



FL



Name	Excitation filter (nm)	Dichroic mirror cut-off (nm)	Emission filter (nm)
<b>B Blue</b>	460 - 500	505	510LP
<b>G Green</b>	510 - 550	570	575LP

<b>SZP-FL</b>	<b>HBO fluorescence attachment for SZP heads</b>
<b>Description:</b>	SZP fluorescence attachment for biology, industrial inspection, criminal justice, etc. Essential tool for security printing and mineral research.
<b>Illumination:</b>	100W HBO high-pressure mercury bulb. Average lamp lifetime: 400 hours. Input voltage: 110/240Vac, 50/60Hz, 1A ; Fuse: F8AL 250V. Maximum input power: 125W. Current and time counter LED displays.
<b>Photo Attachment:</b>	Trinocular output Photo/Video port.

# MODULAR Series - Illuminators

## CLD-01



Flexible and professional cold light illuminator with high power, extra-efficiency 14W LED system, extremely bright and uniform. Optical power: >1000 lumen. Color temperature: pure white 6,300 K. Brightness control potentiometer, external power supply.



CLD-01 with CL-11.1



**CL-17.1:** Additional polarizing filters for CL-11.1

### CLD-01 Accessories

The output can be coupled to the following accessories:

- CL-11.1: Double-arm optical fiber guide with focusing lenses. Arm length 500 mm.
- CL-17.1: Polarizing filters (pair) for CL-11.1.
- CL-12: Ring optical fiber guide (length 700 mm).  
Guide diameter 16 mm.  
Diameter of the fixing ring: 55mm.  
The circular end is suitable for all stereo series.

## CL-11.1

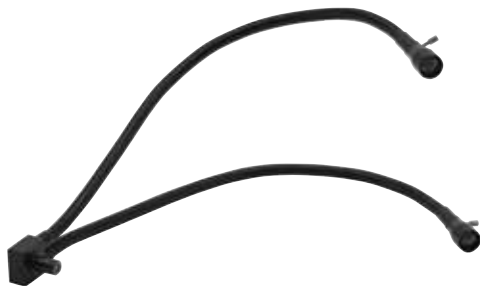

**Double-arm guide for CLD-01, with focusing lenses.**  
Arm length 500 mm. Each arm fitted with focusable lens adapter.  
**Illuminance (at 10 cm distance): 100.000 lux.**  
Optional accessory:  
**CL-17.1:** Polarizing filters (pair) for CL-11.1.

## CL-12



**Ring optical fiber guide for CLD-01.**  
Length 700 mm, diameter 16 mm.  
The circular end is suitable for all series, by using the three locking screws. Diameter of the fixing ring: 55 mm.  
**Illuminance (at 10 cm distance): 40,000 lux.**

## CL-30



### Double-arm Led illuminator.

**Light sources:** LED (x2); With 2W high efficiency LEDs.

**Color temperature:** pure white 6,300 K;

**Luminous flux:** 80 lm each arm;

**Illuminance:** 50,000 lux (at 10 cm distance).

Multi-plug 100-240Vac/12Vdc external power supply.

## CL-31



### Double-arm Led illuminator, with brightness control.

**Light sources:** LED (x2); With 2W high efficiency LEDs.

**Color temperature:** pure white 6,300 K;

**Luminous flux:** 80 lm each arm.

**Illuminance:** 50,000 lux (at 10 cm distance).

Multi-plug 100-240Vac/12Vdc external power supply.

## CL-41



### Double-arm X-LED<sup>3</sup> illuminator, with brightness control.

**Light sources:** With 3,6 W high efficiency X-LED<sup>3</sup>.

**Color temperature:** pure white 6,300 K;

**Luminous flux:** 400 lm each arm;

**Illuminance:** 170,000 lux (at 10 cm distance).

Multi-plug 100-240Vac/12Vdc external power supply.

## CL-14



### 56-LED ring light illuminator, with brightness control.

Compact, with 360° rotating ring connector.

**Illuminance (at 10 cm distance):** >8,000 lux.

Suitable for LAB, SZM and SZO.

# MODULAR Series - Illuminators

## CL-16.1

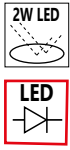

**Professional lighting system** including 144 LEDs (2W total power) for enhanced light uniformity and brightness. The ring light illumination is divided into 4 different zones, individually adjustable for **selectable light zones**. The **separated, external control panel** prevents interferences during use, whilst the sturdy metal structure makes it **more durable and resistant**.

**Diameter of the fixing ring:** 60mm.  
**Color temperature:** pure white 6,300 K.  
**Illuminance:** 6,000 lux (at 10 cm distance).

## CL-18

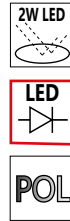

**Professional lighting system** including 96 LEDs for enhanced light uniformity and brightness, and **built-in rotating polarizing filter** and analyzer filters for complete polarization, ideal to reduce glares and reflections when viewing metallic parts.

Provided with **on-board intensity level adjustment**.  
**Diameter of the fixing ring:** 60mm.  
**Color temperature:** pure white 6,300 K.  
**Illuminance:** 9,000 lux (at 10 cm distance).

# MODULAR Series - Stages

## ST-100 & ST-100.1



### Hand moving stage

Dimensions: 185x145mm.  
 Range: 56mm (X) x 35mm (Y).  
 > ST-100: model for SZM-1 and SZM-2.  
 > ST-100.1: model for SZM-LED1, SZM-LED2 and SZO.  
 Please note that this item cannot be combined with SZO-5, SZO-6 and SZ-STL8. Specific versions available also for other models.  
 Note: Fastening on microscope base on request.

## ST-110 & ST-110.1



### Moving stage, with knobs

Manual positioning stage, using knobs for X-Y movements.  
 Dimensions: 180x155mm. Range: 75mm (X) x 54mm (Y).  
 > ST-110: model for SZM-1 and SZM-2.  
 > ST-110.1: model for SZM-LED1, SZM-LED2 and SZO.  
 Please note that this item cannot be combined with SZO-5, SZO-6 and SZ-STL8. Specific versions available also for other models.  
 Note: Fastening on microscope base on request.

## ST-111 & ST-111.1



## ST-666 & ST-666.1



### Moving stage, with micrometer screws

Manual positioning stage, using micrometer screws.

Dimensions: 185x145mm. Range: 25mm (X) x 25mm (Y).

Micrometer screws resolution: 0.01mm.

> ST-111: model for SZM-1 and SZM-2.

> ST-111.1: model for SZM-LED1, SZM-LED2 and SZO.

Please note that this item cannot be combined with SZO-5, SZO-6 and SZ-STL8. Specific versions available also for other models.

Note: Fastening on microscope base on request.

### Heating stage, round

Temperature range: 20°C (room temperature) – 50°C.

Temperature setting resolution: 1°C. Temperature measuring resolution:

0.1°C. Display: LED display for set temperature.

LED display for measured temperature.

> ST-666: model for SZM-1 and SZM-2.

> ST-666.1: model for SZM-LED1, SZM-LED2, SZO and SZ-STL8.

Specific versions available also for other models.

Note: Fastening on microscope base on request.



# MODULAR Series - General Accessories

## Miscellaneous

15104	Cleaning kit
DC-002	Plastic dust cover, medium, 490(l)x490(h) mm
DC-003	TNT dust cover, medium, 600(l)x550(h) mm
DC-004	TNT dust cover, large, 700(l)x550(h) mm
M-005	Micrometric slide, 26x76mm, with 2 scales (1mm/100 & 10mm/100)

### 15104 - Cleaning kit

It cleans glass quickly and effectively, without leaving residue or odor. Ideal for precision lens or prism cleaning.



### How to connect the cameras to our microscopes.

Please refer to the Adapter reference list on Digital section.

v 1.4.0 - OPTIKA reserves the right to make corrections, modifications, enhancements, improvements and other changes to its products at any time without notice.

## Headquarters and Manufacturing Facilities

**OPTIKA® S.r.l.** Via Rigla, 30 - 24010 Ponteranica (BG) - ITALY - Tel.: +39 035.571.392 - info@optikamicroscopes.com

## Optika Sales branches

**OPTIKA® Spain** spain@optikamicroscopes.com  
**OPTIKA® China** china@optikamicroscopes.com  
**OPTIKA® India** india@optikamicroscopes.com

**OPTIKA® USA** usa@optikamicroscopes.com  
**OPTIKA® Central America** america@optikamicroscopes.com

# GEM Series



**Stereozoom Microscopes For Gemology**



## GEM Series

As a leading company in the supply of gemological microscopes, OPTIKA offers 3 series of microscopes purposely designed for this sector by using both brightfield and darkfield methods, SZM-GEM-1 / SZM-GEM-2, OPTIGEM-1 / OPTIGEM-2 and OPTIGEM-3 / OPTIGEM-4. Every microscope has been designed and manufactured in order to satisfy the requests of a very demanding industry; brightfield/darkfield, immersion analysis, light color temperature: no detail has been left to chance.

### Specifically Designed for Specialists

Gemological stereomicroscopes are meant to help with stone inspection. Jewels and gems have a variety of grades (or quality levels), which ultimately influence their value and cost on the market; therefore it is important to have solutions that are purposely designed for gemology. These stereomicroscopes are equipped with iris and darkfield condenser on the bottom light source, and with a set of on stage tweezers to hold the stone in place.

### Much More Than Gemological Stereomicroscopes

**OPTIGEM-1 & OPTIGEM-2** are two-in-one gemology instruments that can be used both in vertical and horizontal position in a very easy way, just by turning one knob (no disassembling and re-assembling operations are required). The horizontal position extends the use of a gemological microscope, giving the possibility to perform immersion analysis by submerging a sample in liquid. If the stone's refractive index is close to the liquid's one, immersion makes the interior more visible by reducing the effects of refraction and surface reflection. This enables you to see a gem's inclusions or color distribution more easily.

Immersion is also necessary to see crystal growth structures, which might help you separate natural from synthetic corundum. Features like curved growth striae in flame-fusion synthetics, or separation planes in assembled stones, are often far easier to see when the stone is immersed.



**Vertical position for standard gem analysis with darkfield illumination and polarizing technique**



**Horizontal position for immersion gem analysis**

### Incredibly Versatile Operations

**OPTIGEM Series** offers multiple options for illumination and contrast techniques, such as incident, transmitted and oblique brightfield darkfield, polarization and immersion analysis only on Optigem 1 & 2. They come with a special optical condenser configuration to ensure real, perfect darkfield application (see the dedicated chapter for further information).



# Stereozoom Microscopes For Gemology

## Ultrabright LED Condenser for Optimized Illumination

An ultrabright LED-based electronic condenser with intensity control allows to switch from brightfield to darkfield; it also produces perfectly the colour of daylight. The condenser uses a new optical configuration especially created in order to obtain a perfect darkfield application.

With darkfield observation, the unscattered beams from the image are excluded: as a result, the field around the specimen is generally dark.

An additional flexible arm and velvet-field slider produce extra contrast for crisp and vibrant images. The illumination of OPTIGEM microscopes is greatly performing and this brings this series to be ideal for precious stones and jewels evaluation.



## Get the most out of our accessories

A wide range of optional accessories completes these instruments: from gemology clip, iris aperture diaphragm, polarization analysis kit, optical unit to switch the darkfield from a "sharp" (gem exhibition) to a "soft" (diamond analysis) mode, translating cell holder with vacuum pick-up and quartz immersion cells complete and enhance the OPTIGEM-1 & OPTIGEM-2 performances. All the accessories can be stacked, in any order, while using the microscope both horizontally and vertically.

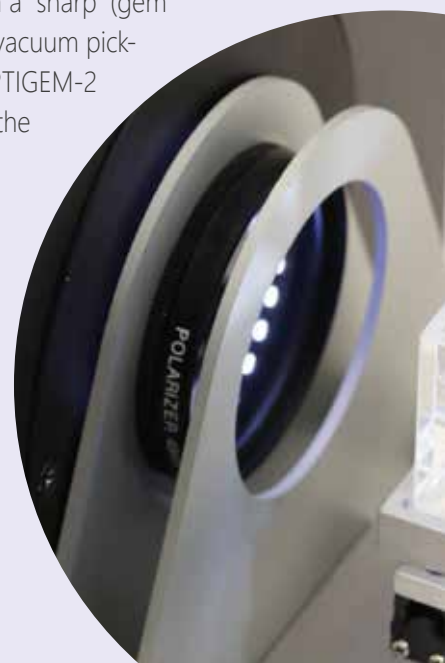
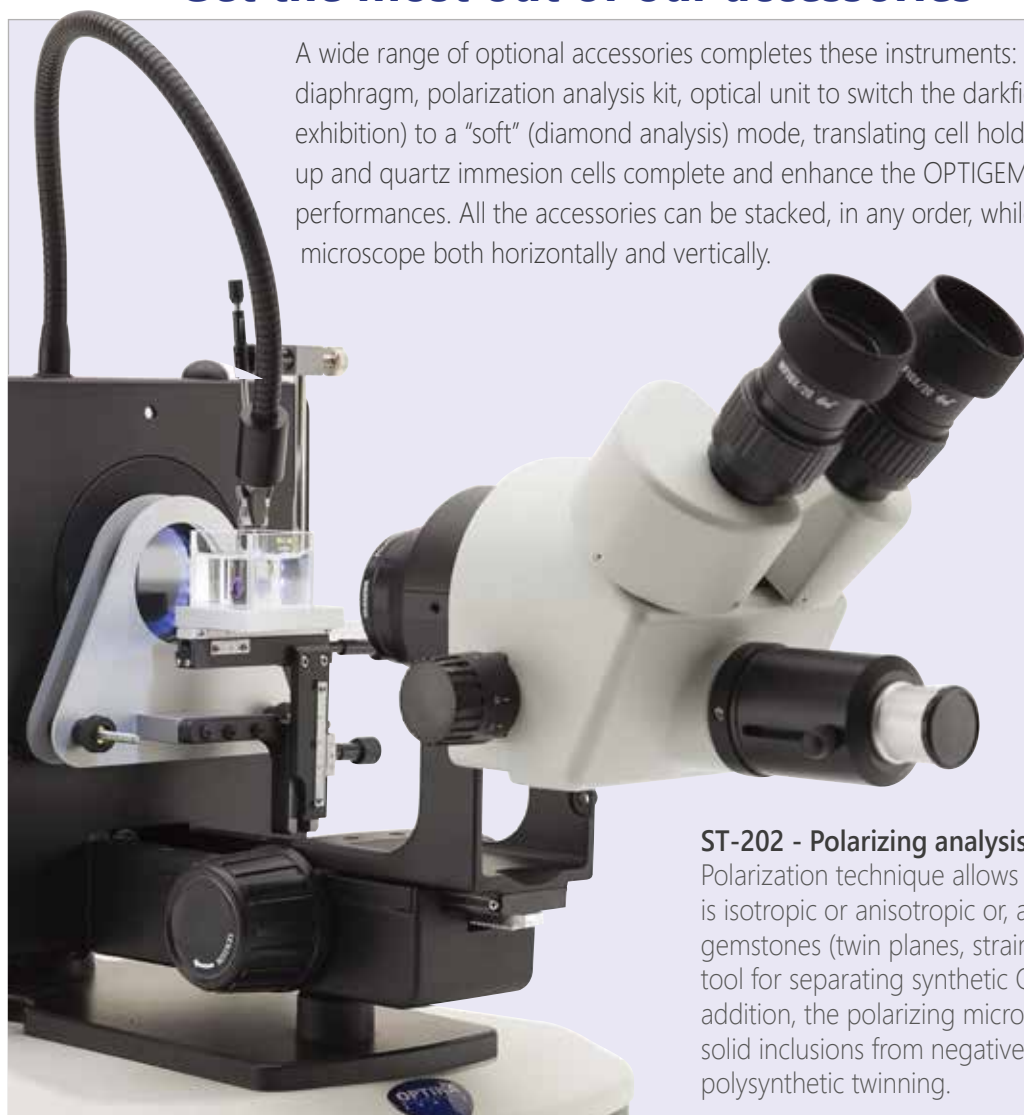

**ST-202**

### ST-202 - Polarizing analysis kit

Polarization technique allows to quickly determine if the stone at hand is isotropic or anisotropic or, at best, to determine the optic character of gemstones (twin planes, strain, pleochroism, etc.). It is also the preferred tool for separating synthetic Quartz from its natural counterparts. In addition, the polarizing microscope may be very useful for distinguishing solid inclusions from negative inclusions as well as for spotting polysynthetic twinning.

# GEM Series

## Applications

Some application examples demonstrating the performance of OPTIGEM Series, especially designed to observe samples of precious stones and jewels and provided with specific features for gemological needs.

## Legend



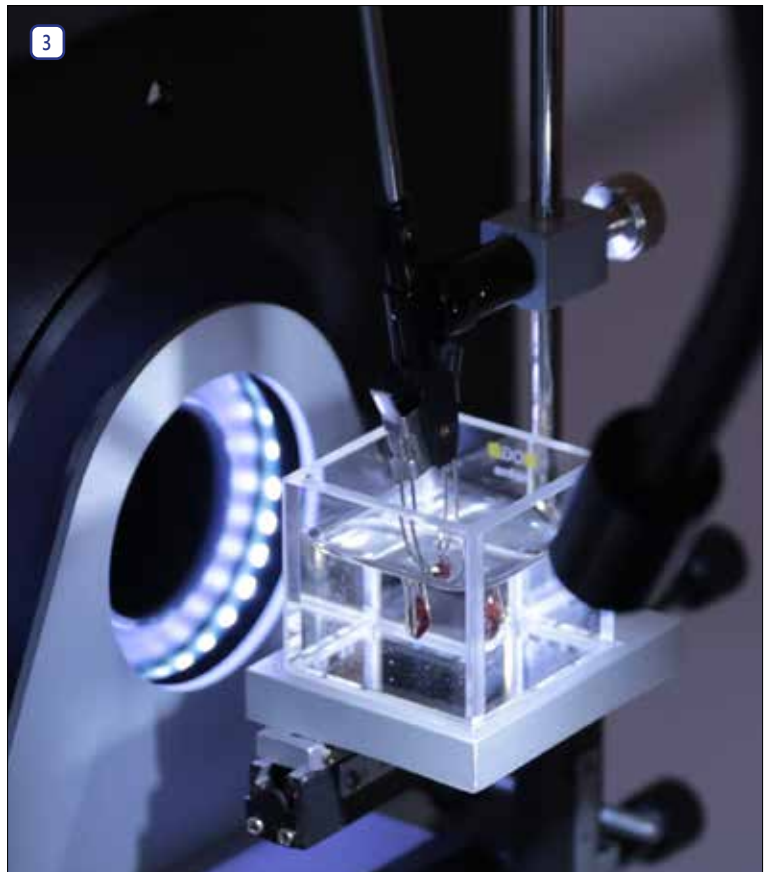

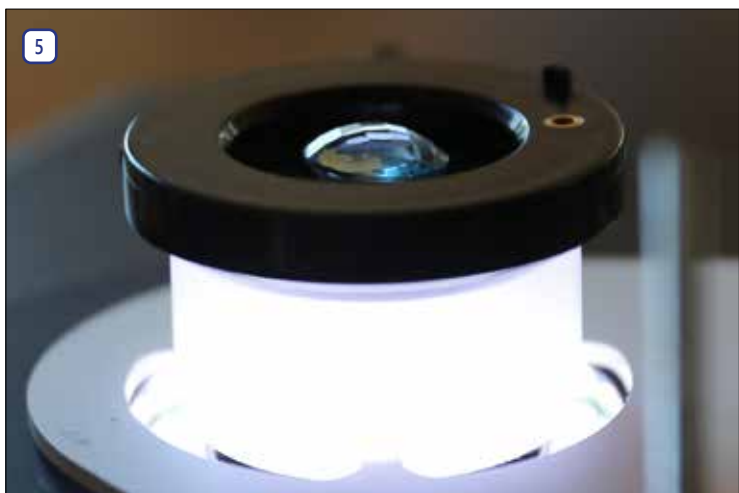
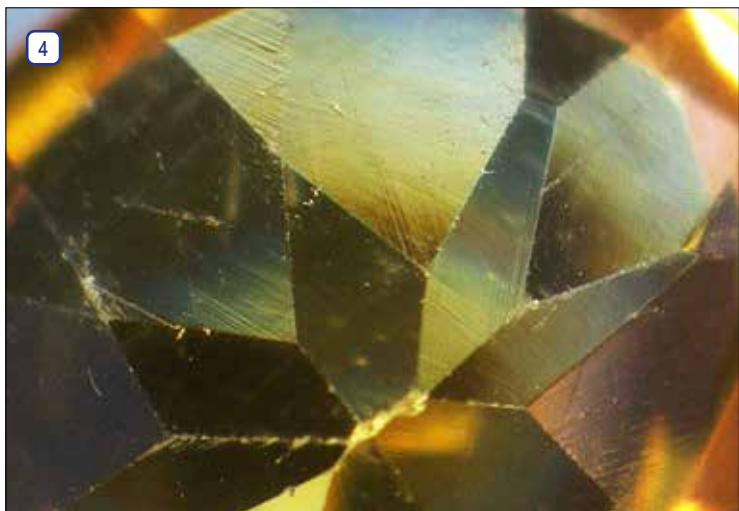

1. Inspection of stones with SZM-GEM-1.
2. Inspection of stones with pure white darkfield illumination.
3. Immersion cell (ST-203) on a translating support (ST-204).
4. Sample of Citrine.
5. ST-201 accessory creates a soft darkfield illumination ideal for diamond analysis.
6. Optigem can be easily rotated to a horizontal working position.
7. ST-201 accessory for analysis under polarized light.
8. Working with Optigem and its accessories (they can be stacked for increased functionality).





# GEM Series - Range

## OPTIGEM 1

-  21
-  0.7x-4.5x
-  X-LED
-  3W LED
-  4W LED
-  DF



Binocular gemological stereomicroscopes for brightfield and darkfield applications with special side-emitting **LED** illumination ring for true darkfield illumination. Equipped also with an incident **LED** flexible arm and a diffusive **LED** disc for transmitted illumination. The instrument can be easily tilted horizontally for immersion analysis.

**Observation mode:** Brightfield, darkfield.

**Heads:** Binocular, 45° inclined, 360° rotating.

**Interpupillary distance:** Adjustable between 51 and 75 mm.

**Dioptric adjustment:** On both eyepiece tubes.

**Eyepieces:** WF10x/21 mm, high eye-point.

**Objective:** Parfocal achromatic zoom 0.7x...4.5x (zoom factor 6.43:1).

**Working distance:** 100 mm.

**Specimen stage:** Gemological stage, with clamp for holding gems.

**Focusing:** Rack and pinion mechanism controlled by a pair of knobs.

**Stand:** Fixed arm stand with tilting system (with position lock control). It can be totally overturned and rotated allowing in this way to obtain a 2-in-one instrument: an instrument for standard observations and one for observation of water-immersed gems.





**Darkfield illumination:** Equipped with a state-of-the-art illuminator for darkfield observation. It consist of an innovative side-emitting LEDs ring with an emission angle of 38°. With brightness control.

**Transmitted light illumination:** Equipped with a LED illuminator, located under the stage. With brightness control.

**Incident illumination:** Equipped with a flexible gooseneck-arm LED illuminator. With brightness control.

**Color temperature:** Pure white 6,300 K

## OPTIGEM 2

-  21
-  0.7x-4.5x
-  X-LED
-  3W LED
-  4W LED
-  DF



Trinocular gemological stereomicroscopes for brightfield and darkfield applications with special side-emitting **LED** illumination ring for true darkfield illumination. Equipped also with an incident **LED** flexible arm and a diffusive **LED** disc for transmitted illumination. The instrument can be easily tilted horizontally for immersion analysis.

**Observation mode:** Brightfield, darkfield.

**Heads:** Trinocular, 45° inclined, 360° rotating.

**Interpupillary distance:** Adjustable between 51 and 75 mm.

**Dioptric adjustment:** On both eyepiece tubes.

**Eyepieces:** WF10x/21 mm, high eye-point.

**Objective:** Parfocal achromatic zoom 0.7x...4.5x (zoom factor 6.43:1).

**Working distance:** 100 mm.

**Specimen stage:** Gemological stage, with clamp for holding gems.

**Focusing:** Rack and pinion mechanism controlled by a pair of knobs.

**Stand:** Fixed arm stand with tilting system (with position lock control). It can be totally overturned and rotated allowing in this way to obtain a 2-in-one instrument: an instrument for standard observations and one for observation of water-immersed gems.

**Darkfield illumination:** Equipped with a state-of-the-art illuminator for darkfield observation. It consist of an innovative side-emitting LEDs ring with an emission angle of 38°. With brightness control.

**Transmitted light illumination:** Equipped with a LED illuminator, located under the stage. With brightness control.

**Incident illumination:** Equipped with a flexible gooseneck-arm LED illuminator. With brightness control.

**Color temperature:** Pure white 6,300 K

## OPTIGEM 3

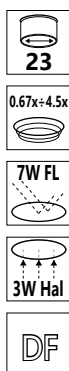

Binocular gemological stereomicroscopes for brightfield and darkfield applications. The darkfield condenser uses a typical optical configuration, based on halogen illumination and a classic reflecting system. A flexible arm with a fluorescent tube simulates the color of daylight for accurate color grading. The stand can be inclined backward by 45° for to increase comfort and ergonomoy.

**Observation mode:** Brightfield, darkfield.

**Heads:** Binocular, 45° inclined, 360° rotating.

**Interpupillary distance:** Adjustable between 51 and 75 mm.

**Dioptric adjustment:** On both eyepiece tubes.

**Eyepieces:** WF10x/23 mm, high eye-point.

**Objective:** Parfocal achromatic zoom 0.67x...4.5x (zoom factor 6.7:1).

**Working distance:** 110 mm.

**Specimen stage:** Gemological stage, with clamp for holding gems.

**Focusing:** Rack and pinion mechanism controlled by a pair of knobs.

**Stand:** Fixed arm stand with tilting system. It can be inclined up to 45°

**Darkfield illumination:** Equipped with a 30W halogen illuminator and a darkfield condenser. With brightness control.

**Transmitted light illumination:** Selectable by using a specific darkfield/brightfield switching control, it uses the same halogen source of darkfield illuminator. With brightness control.

**Incident illumination:** Equipped with a flexible gooseneck-arm with fluorescent tube. With brightness control.

**Color temperature:** Pure white 6,300 K

## OPTIGEM 4

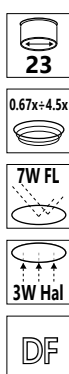

Trinocular gemological stereomicroscopes for brightfield and darkfield applications. The darkfield condenser uses a typical optical configuration, based on halogen illumination and a classic reflecting system. A flexible arm with a fluorescent tube simulates the color of daylight for accurate color grading. The stand can be inclined backward by 45° for to increase comfort and ergonomoy.

**Observation mode:** Brightfield, darkfield.

**Heads:** Trinocular, 45° inclined, 360° rotating.

**Interpupillary distance:** Adjustable between 51 and 75 mm.

**Dioptric adjustment:** On both eyepiece tubes.

**Eyepieces:** WF10x/23 mm, high eye-point.

**Objective:** Parfocal achromatic zoom 0.67x...4.5x (zoom factor 6.7:1).

**Working distance:** 110 mm.

**Specimen stage:** Gemological stage, with clamp for holding gems.

**Focusing:** Rack and pinion mechanism controlled by a pair of knobs.

**Stand:** Fixed arm stand with tilting system. It can be inclined up to 45°

**Darkfield illumination:** Equipped with a 30W halogen illuminator and a darkfield condenser. With brightness control.

**Transmitted light illumination:** Selectable by using a specific darkfield/brightfield switching control, it uses the same halogen source of darkfield illuminator. With brightness control.

**Incident illumination:** Equipped with a flexible gooseneck-arm with fluorescent tube. With brightness control.

**Color temperature:** Pure white 6,300 K

# GEM Series - Range

## SZM-GEM-1 / SZM-GEM-2



**SZM-GEM-1**  
Gemological microscope  
with binocular head



**SZM-GEM-2**  
Gemological microscope  
with trinocular head

**Gemological stereomicroscopes with pillar stand and illuminated stage for brightfield and darkfield applications with special LED illumination ring for true darkfield illumination.**

**Observation mode:** Brightfield, darkfield.

**Heads:** Binocular or trinocular, 45° inclined, 360° rotating.

**Interpupillary distance:** Adjustable between 51 and 75 mm.

**Dioptric adjustment:** On both eyepiece tubes.

**Eyepieces:** WF10x/21 mm, high eye-point.

**Objective:** Parfocal achromatic zoom 0.7x...4.5x (zoom factor 6.43:1).

**Working distance:** 100 mm.

**Specimen stage:** Gemological stage, with clamp for holding gems.

**Focusing:** Rack and pinion mechanism controlled by a pair of knobs.

**Stand:** Pillar stand 32 mm diameter and 250 mm high, base: 260x200x60h mm.

**Darkfield illumination:** Equipped with a state-of-the-art illuminator for darkfield observation. It consist of an innovative side-emitting LEDs ring with an emission angle of 38°. With brightness control.

**Transmitted light illumination:** Equipped with a LED illuminator, located under the stage. With brightness control.

**Incident illumination:** Dichroic halogen lamp 12V/15W. With brightness control.

**Color temperature:** Pure white 6,300 K

**SZM-GEM-1:** Equipped with binocular head.

**SZM-GEM-2:** Equipped with trinocular head.

## GEM Series - Comparison chart

Model	Head	Eyepieces	Objective	Stand	Illumination
<b>OPTIGEM-1</b>	Binocular, 360° rotating, 45° inclined	Wide Field 10x/21mm	0.7 .... 4.5x Zoom	Gemological stand	<b>Incident illumination:</b> LED flexible arm with brightness adjustment. <b>Transmitted illumination:</b> Diffusive LED disc for observation in brightfield and side-emitting LED ring for observation in darkfield.
<b>OPTIGEM-2</b>	Trinocular, 360° rotating, 45° inclined	Wide Field 10x/21mm	0.7 .... 4.5x Zoom	Gemological stand	<b>Incident illumination:</b> LED flexible arm with brightness adjustment. <b>Transmitted illumination:</b> Diffusive LED disc for observation in brightfield and side-emitting LED ring for observation in darkfield.
<b>OPTIGEM-3</b>	Binocular, 360° rotating, 45° inclined	Wide Field 10x/23mm	0.67 .... 4.5x Zoom	Gemological stand	<b>Incident illumination:</b> flexible arm with fluorescent tube 7W (pure white). <b>Transmitted illumination:</b> 30W halogen bulb and a dedicated reflecting system for observation with brightfield and darkfield.
<b>OPTIGEM-4</b>	Trinocular, 360° rotating, 45° inclined	Wide Field 10x/23mm	0.67 .... 4.5x Zoom	Gemological stand	<b>Incident illumination:</b> flexible arm with fluorescent tube 7W (pure white). <b>Transmitted illumination:</b> 30W halogen bulb and a dedicated reflecting system for observation with brightfield and darkfield.
<b>SZM-GEM-1</b>	Binocular, 360° rotating, 45° inclined	Wide Field 10x/21mm	0.7x...4.5x zoom	Pillar stand	<b>Incident illumination:</b> dichroic halogen lamp 12V/15W. <b>Transmitted illumination:</b> Diffusive LED disc for observation in brightfield and side-emitting LED ring for observation in darkfield.
<b>SZM-GEM-2</b>	Trinocular, 360° rotating, 45° inclined	Wide Field 10x/21mm	0.7x...4.5x zoom	Pillar stand	<b>Incident illumination:</b> dichroic halogen lamp 12V/15W. <b>Transmitted illumination:</b> Diffusive LED disc for observation in brightfield and side-emitting LED ring for observation in darkfield.

# GEM Series - Optical Performance

## OPTIGEM-1 / OPTIGEM-2 - Optical performance

Eyepiece	10x (ST-081)		15x (ST-082)		20x (ST-083)	
Field number (mm)	21		15		10	
Objective	Total magnification	Field of View (mm)	Total magnification	Field of View (mm)	Total magnification	Field of View (mm)
0.5x (W.D. 165 mm)	3.5x-22.5x	60.00-9.23	5.25x-33.75x	42.86-6.67	7x-45x	28.57-4.44
0.75x (W.D. 117 mm)	5.25x-33.75x	40.00-6.22	7.875x-50.625x	28.57-4.44	10.50x-67.5x	19.05-2.96
1x (W.D. 100 mm)	7x-45x	30.00-4.66	10.5x-67.5x	21.43-3.33	14x-90x	14.29-2.22
1.5x (W.D. 47 mm)	10.50x-67.5x	20.00-3.11	15.75x-101.25x	14.29-2.22	21x-135x	9.52-1.48
2x (W.D. 33 mm)	14x-90x	15.00-2.33	21x-135x	10.71-1.67	28x-180x	7.14-1.11

## OPTIGEM-3 / OPTIGEM-4 - Optical performance

Eyepiece	10x (ST-301)		15x (ST-302)		20x (ST-303)		25x (ST-144)	
Field number (mm)	23		16		12		9	
Objective	Total magnification	Field of View (mm)	Total magnification	Field of View (mm)	Total magnification	Field of View (mm)	Total magnification	Field of View (mm)
0.3x (W.D: 287 mm)	2.01x-13.5x	114.43-17.04	3.02x-20.25x	79.60-11.85	4.02x-27x	59.70-8.89	5.025x-33.75x	44.78-6.67
0.5x (W.D: 177 mm)	3.35x-22.5x	68.66-10.22	5.02x-33.75x	47.76-7.11	6.7x-45x	35.82-5.33	8.375x-56.25x	26.87-4.00
0.75x (W.D: 120 mm)	5.02x-33.75x	45.77-6.81	7.54x-50.63x	31.84-4.74	10.05x-67.5x	23.88-3.56	12.5625x-84.375x	17.91-2.67
1x (W.D: 110 mm)	6.7x-45x	34.33-5.11	10.05x-67.50x	23.88-3.56	13.4x-90x	17.91-2.67	16.75x-112.5x	13.43-2.00
1.5x (W.D: 47 mm)	10.05x-67.5x	22.89-3.41	15.08x-101.25	15.92-2.37	20.1x-135x	11.94-1.78	25.125x-168.75x	8.96-1.33
2x (W.D: 26 mm)	13.4x-90x	17.16-2.56	20.10x-135.00x	11.94-1.78	26.8x-180x	8.96-1.33	33.5x-225x	6.72-1.00

## SZM-GEM-1 / SZM-GEM-2 - Optical performance

Eyepiece	10x (ST-081)		15x (ST-082)		20x (ST-083)	
Field number (mm)	21		15		10	
Objective	Total magnification	Field of View (mm)	Total magnification	Field of View (mm)	Total magnification	Field of View (mm)
0.5x (W.D. 165 mm)	3.5x-22.5x	60.00-9.23	5.25x-33.75x	42.86-6.67	7x-45x	28.57-4.44
0.75x (W.D. 117 mm)	5.25x-33.75x	40.00-6.22	7.875x-50.625x	28.57-4.44	10.50x-67.5x	19.05-2.96
1x (W.D. 100 mm)	7x-45x	30.00-4.66	10.5x-67.5x	21.43-3.33	14x-90x	14.29-2.22
1.5x (W.D. 47 mm)	10.50x-67.5x	20.00-3.11	15.75x-101.25x	14.29-2.22	21x-135x	9.52-1.48
2x (W.D. 33 mm)	14x-90x	15.00-2.33	21x-135x	10.71-1.67	28x-180x	7.14-1.11

## GEM Series - Contrast method comparison

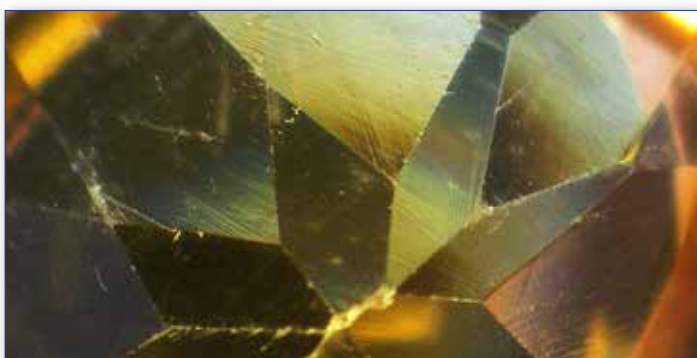

Citrine - OPTIGEM-2 - 0.7x zoom - Brightfield

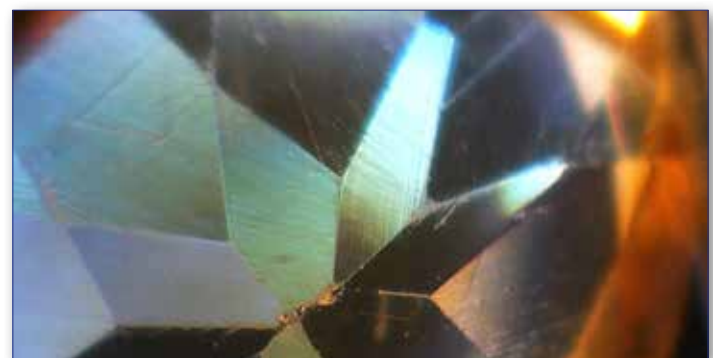

Citrine - OPTIGEM-2 - 0.7x zoom - Darkfield

# GEM Series - Accessories

## Eyecups & Eyepieces

- ST-081 EW10x/21 eyepieces (pair), high eyepoint, with rubber cup (except for OPTIGEM-3 & OPTIGEM-4)
- ST-082 WF15x/15 eyepieces (pair), high eyepoint (except for OPTIGEM-3 & OPTIGEM-4)
- ST-083 WF20x/10 eyepieces (pair), high eyepoint (except for OPTIGEM-3 & OPTIGEM-4)
- ST-084 WF10x/21 micrometric eyepiece, high eyepoint, with rubber cup (except for OPTIGEM-3 & OPTIGEM-4)
- ST-144 WF25x/9 eyepieces (pair), high eyepoint, focusable, with rubber cup (only for OPTIGEM-3 & OPTIGEM-4)
- ST-301 WF10x/23 eyepieces (pair), high eyepoint, focusable, with rubber cup (only for OPTIGEM-3 & OPTIGEM-4)
- ST-302 WF15x/16 eyepieces (pair), high eyepoint, focusable, with rubber cup (only for OPTIGEM-3 & OPTIGEM-4)
- ST-303 WF20x/12 eyepieces (pair), high eyepoint, focusable, with rubber cup (only for OPTIGEM-3 & OPTIGEM-4)
- ST-305 WF10x/23 micrometric eyepiece, high eyepoint, focusable, rubber cup (only for OPTIGEM-3 & OPTIGEM-4)

## Objectives & Additional Lenses

- ST-086.1 Additional lens 1.5x (w.d. 45mm) with compensating disc (except for OPTIGEM-3 & OPTIGEM-4)
- ST-087 Additional lens 2x (w.d. 33mm) (except for OPTIGEM-3 & OPTIGEM-4)
- ST-105 Additional lens 1.5x (w.d. 47mm) (only for OPTIGEM-3 & OPTIGEM-4)
- ST-106 Additional lens 2x (w.d. 26mm) (only for OPTIGEM-3 & OPTIGEM-4)

## Condenser & Filters

- ST-202 Polarizing analysis kit (only for OPTIGEM-1 & OPTIGEM-2)
- ST-230 Polarizing analysis kit (only for SZM-GEM1 & SZM-GEM2)
- ST-231 Polarizing analysis kit (only for OPTIGEM-3 & OPTIGEM-4)

## Camera Adapters

- M-113.1 Ring adapter, 30mm (for monocular and binocular microscopes)
- M-115 0.35x C-Mount projection lens
- M-114 0.5x C-Mount projection lens
- M-118 0.75x C-Mount projection lens
- M-173 C-Mount projection lens for APS-C/full frame reflex cameras (trino)
- M-699 Universal adapter for C-Mount projection lens (trino)
- ST-090 0.35x focusable C-Mount adapter (stereomicroscopes)
- ST-090.1 0.5x focusable C-Mount adapter (stereomicroscopes)
- ST-090.2 0.65x focusable C-Mount adapter (stereomicroscopes)
- M-620.3 1x focusable C-Mount adapter (biological & stereomicroscopes)

## Miscellaneous

- 15104 Cleaning kit
- DC-002 Plastic dust cover, medium, 490(l)x490(h) mm
- M-005 Micrometric slide, 26x76mm, with 2 scales (1mm/100 & 10mm/100)
- M-621 Halogen bulb 6V/30W (only for OPTIGEM-3 & OPTIGEM-4)
- ST-092 Protective glass for stereohead
- ST-201 Iris aperture diaphragm for darkfield (only for OPTIGEM-1 & OPTIGEM-2)
- ST-203 Glass immersion cell (only for OPTIGEM-1 & OPTIGEM-2)
- ST-204 Translating cell holder (only for OPTIGEM-1 & OPTIGEM-2)
- ST-205 Vacuum pick-up (with electric vacuum pump) (only for OPTIGEM-1 & OPTIGEM-2)
- ST-207 Iris aperture diaphragm for brightfield (only for OPTIGEM-1 & OPTIGEM-2)

### 15104 - Cleaning kit

It cleans glass quickly and effectively, without leaving residue or odor. Ideal for precision lens or prism cleaning.



### How to connect the cameras to our microscopes.

Please refer to the Adapter reference list on Digital section.

v 1.4.0 - OPTIKA reserves the right to make corrections, modifications, enhancements, improvements and other changes to its products at any time without notice.

## Headquarters and Manufacturing Facilities

**OPTIKA® S.r.l.** Via Rigla, 30 - 24010 Ponteranica (BG) - ITALY - Tel.: +39 035.571.392 - info@optikamicroscopes.com

## Optika Sales branches

**OPTIKA® Spain** spain@optikamicroscopes.com  
**OPTIKA® China** china@optikamicroscopes.com  
**OPTIKA® India** india@optikamicroscopes.com

**OPTIKA® USA** usa@optikamicroscopes.com  
**OPTIKA® Central America** c-america@optikamicroscopes.com



# MET SERIES



**Metallurgical Microscopes**

# Metallurgical Microscopy

Metallography is the study of the physical structure and components of metals, by using microscopy. Many different microscopy techniques are used in metallographic analysis.

Prepared specimens should be examined with the unaided eye after etching to detect any visible areas that have responded to the etchant differently from the norm as a guide to where microscopical examination should be employed. Light optical microscopy (LOM) examination should always be performed prior to any electron metallographic (EM) technique, as these are more time-consuming to perform and the instruments are much more expensive.

Further, certain features can be best observed with the LOM, e.g., the natural color of a constituent can be seen with the LOM but not with EM systems. Also, image contrast of microstructures at relatively low magnifications, e.g., <500X, is far better with the LOM than with the scanning electron microscope (SEM), while transmission electron microscopes (TEM) generally cannot be utilized at magnifications below about 2000 to 3000X. LOM examination is fast and can cover a large area. Thus, the analysis can determine if the more expensive, more time-consuming examination techniques using the SEM or the TEM are required and where on the specimen the work should be concentrated.

## Brightfield and darkfield microscopy

Most LOM observations are conducted using bright-field (BF) illumination, where the image of any flat feature perpendicular to the incident light path is bright, or appears to be white. But, other illumination methods can be used and, in some cases, may provide superior images with greater detail. Dark-field microscopy (DF), is an alternative method of observation that provides high-contrast images and actually greater resolution than bright-field. In dark-field illumination, the light from features perpendicular to the optical axis is blocked and appears dark while the light from features inclined to the surface, which look dark in BF, appear bright, or "self-luminous" in DF. Grain boundaries, for example, are more vivid in DF than BF.

## Polarized light microscopy

Polarized light (PL) is very useful when studying the structure of metals with non-cubic crystal structures (mainly metals with hexagonal close-packed (hcp) crystal structures). If the specimen is prepared with minimal damage to the surface, the structure can be seen vividly in cross-polarized light (the optic axis of the polarizer and analyzer are 90 degrees to each other, i.e., crossed). In some cases, an hcp metal can be chemically etched and then examined more effectively with PL. Tint etched surfaces, where a thin film (such as a sulfide, molybdate, chromate or elemental selenium film) is grown epitaxially on the surface to a depth where interference effects are created when examined with BF producing color images, can be improved with PL. If it is difficult to get a good interference film with good coloration, the colors can be improved by examination in PL using a sensitive tint (ST) filter.

## Differential interference contrast microscopy

Another useful imaging mode is differential interference contrast (DIC), which is usually obtained with a system designed by the Polish physicist Georges Nomarski. This system gives the best detail. DIC converts minor height differences on the plane-of-polish, invisible in BF, into visible detail. The detail in some cases can be quite striking and very useful. If an ST filter is used along with a Wollaston prism, color is introduced. The colors are controlled by the adjustment of the Wollaston prism, and have no specific physical meaning, per se. But, visibility may be better.



## Oblique illumination

DIC has largely replaced the older oblique illumination (OI) technique, which was available on reflected light microscopes prior to about 1975. In OI, the vertical illuminator is offset from perpendicular, producing shading effects that reveal height differences. This procedure reduces resolution and yields uneven illumination across the field of view. Nevertheless, OI was useful when people needed to know if a second phase particle was standing above or was recessed below the plane-of-polish, and is still available on a few microscopes. OI can be created on any microscope by placing a piece of paper under one corner of the mount so that the plane-of-polish is no longer perpendicular to the optical axis.

# B-383MET - Metallurgical Microscope

Brightfield upright microscope with IOS W-PLAN MET objectives and metallurgical attachment combining the exclusive **X-LED<sup>3</sup>** lighting source both for incident and transmitted illumination. The NCG (no cover glass) objectives are especially designed for microscopy use without a cover slip ideal for metallographic samples and other opaque specimens.

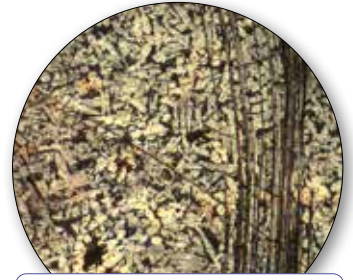

4x

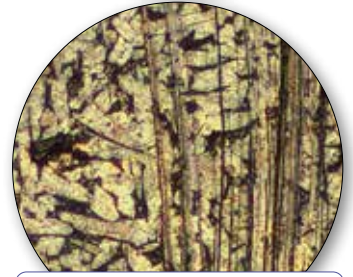

10x

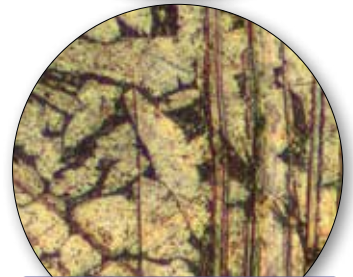

20x

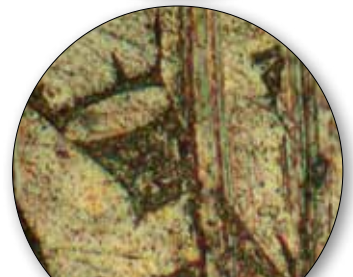

50x

Part	Description
<b>Observation mode:</b>	Brightfield, incident polarized light.
<b>Epi-illumination and polarizing filters:</b>	X-LED <sup>3</sup> with white 3.6 W LED (6.300 K) with brightness control. Field and aperture diaphragms, polarizer & analyzer filters.
<b>Head:</b>	Trinocular (fixed 50/50), 30° inclined, 360° rotating.
<b>Interpupillary distance:</b>	Adjustable between 48 and 75 mm.
<b>Dioptric adjustment:</b>	On the left eyepiece tube.
<b>Eyepieces:</b>	WF10x/20 mm, high eye-point and secured by screw.
<b>Nosepiece:</b>	Quintuple revolving nosepiece, rotation on ball bearings.

Part	Description
<b>Objectives (strain-free):</b>	IOS W-PLAN MET 5x/0.12 IOS W-PLAN MET 10x/0.25 IOS W-PLAN MET 20x/0.40 IOS W-PLAN MET 50x/0.75 All with anti-fungus treatment.
<b>Specimen stage:</b>	Double layer rackless mechanical stage, 233x147 mm, 78x54 mm X-Y range. With tempered glass plate.
<b>Focusing:</b>	Coaxial coarse (adjustable tension) and fine focusing mechanism with limit stop to prevent the contact between objective and specimen.
<b>Condenser:</b>	Abbe N.A. 1.25, with objective-coded iris diaphragm, focusable and centerable.
<b>Transmitted illumination (Fixed Koehler type):</b>	X-LED <sup>3</sup> with white 3.6 W LED (6.300 K) with brightness control. Multi-plug 100-240Vac/6Vdc external power supply.

# B-510MET - Metallurgical Microscope

Advanced routine laboratory microscope with IOS W-PLAN MET objectives and metallurgical attachment with the exclusive **X-LED<sup>3</sup>** lighting source for incident illumination only. The NCG (no cover glass) objectives are especially designed for microscopy use without a cover slip ideal for metallographic samples and other opaque specimens.

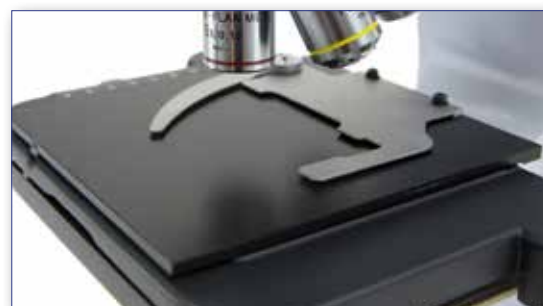
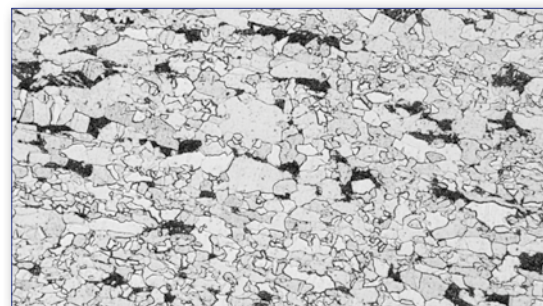

Part	Description
<b>Observation mode:</b>	Brightfield, simple polarized light, oblique illumination on incident light.
<b>Epi-illumination and polarizing filters:</b>	X-LED <sup>3</sup> with white 8 W LED (6.300 K) with brightness control. With aperture and field diaphragms, and oblique illumination system. With polarizer and analyzer. Multi-plug 100-240Vac/6Vdc external power supply.
<b>Head:</b>	Trinocular (fixed 50/50), 30° inclined, 360° rotating.
<b>Interpupillary distance:</b>	Adjustable between 50 and 75 mm.
<b>Dioptric adjustment:</b>	On the left eyepiece tube.
<b>Eyepieces:</b>	WF10x/22 mm, high eye-point and with rubber cups.
<b>Nosepiece:</b>	Quintuple revolving nosepiece, rotation on ball bearings.

Part	Description
<b>Objectives (strain-free):</b>	IOS W-PLAN MET 5x/0.12 IOS W-PLAN MET 10x/0.25 IOS W-PLAN MET 20x/0.40 IOS W-PLAN MET 50x/0.75 All with anti-fungus treatment.
<b>Specimen stage:</b>	Double layer rackless mechanical stage, 233x147 mm, 78x54 mm X-Y range.
<b>Focusing:</b>	Coaxial coarse (adjustable tension) and fine focusing mechanism with limit stop to prevent the contact between objective and specimen.

# B-510METR - Metallurgical Microscope

Advanced routine laboratory microscope with IOS W-PLAN MET objectives and metallurgical attachment with the exclusive **X-LED<sup>3</sup>** lighting source for both transmitted and incident illumination. The NCG (no cover glass) objectives are especially designed for microscopy use without a cover slip ideal for metallographic samples and other opaque specimens.

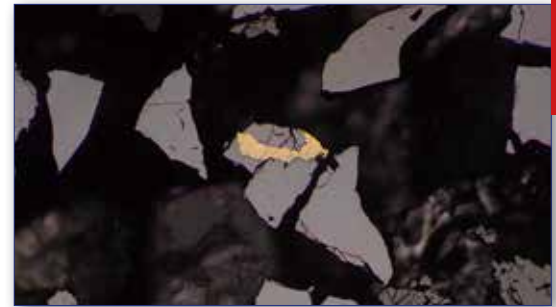

Part	Description
<b>Observation mode:</b>	Brightfield on transmitted light. Brightfield, simple polarized light, oblique illumination on incident light.
<b>Epi-illumination and polarizing filters:</b>	X-LED <sup>8</sup> with white 8 W LED (6.300 K) with brightness control. With aperture and field diaphragms, and oblique illumination system. With polarizer and analyzer.
<b>Head:</b>	Trinocular (fixed 50/50), 30° inclined, 360° rotating.
<b>Interpupillary distance:</b>	Adjustable between 50 and 75 mm.
<b>Dioptric adjustment:</b>	On the left eyepiece tube.
<b>Eyepieces:</b>	WF10x/22 mm, high eye-point and with rubber cups.
<b>Nosepiece:</b>	Quintuple revolving nosepiece, rotation on ball bearings.

Part	Description
<b>Objectives (strain-free):</b>	IOS W-PLAN MET 5x/0.12 IOS W-PLAN MET 10x/0.25 IOS W-PLAN MET 20x/0.40 IOS W-PLAN MET 50x/0.75 All with anti-fungus treatment.
<b>Specimen stage:</b>	Double layer rackless mechanical stage, 233x147 mm, 78x54 mm X-Y range. With tempered glass plate.
<b>Focusing:</b>	Coaxial coarse (adjustable tension) and fine focusing mechanism with limit stop to prevent the contact between objective and specimen.
<b>Condenser:</b>	Swing-out N.A. 0.2/0.9, with iris diaphragm, focusable and centerable.
<b>Transmitted illumination (Full Koehler type):</b>	X-LED <sup>3</sup> with white 3.6 W LED (6.300 K) with brightness control. Multi-plug 100-240Vac/6Vdc external power supply.

# 3 B-1000MET - Metallurgical Microscope

The modular OPTIKA B-1000 is available with brightfield and darkfield incident light, helping you working in a comfortable way during extended periods of use and performing reliable, accurate and rapid diagnosis benefiting from modularity, which gives the chance to create customized configurations tailored on customer needs. Versatile, robust, durable and sturdy, B-1000 offers premium quality optics, the state-of-the-art, exclusive **X-LED<sup>®</sup>** (8 W) illumination system, designed by OPTIKA and the Koehler diaphragm. Incident light through 100 W halogen lamp or 18 W LED illumination. B-1000 gives multiple options as manual or motorized configuration.

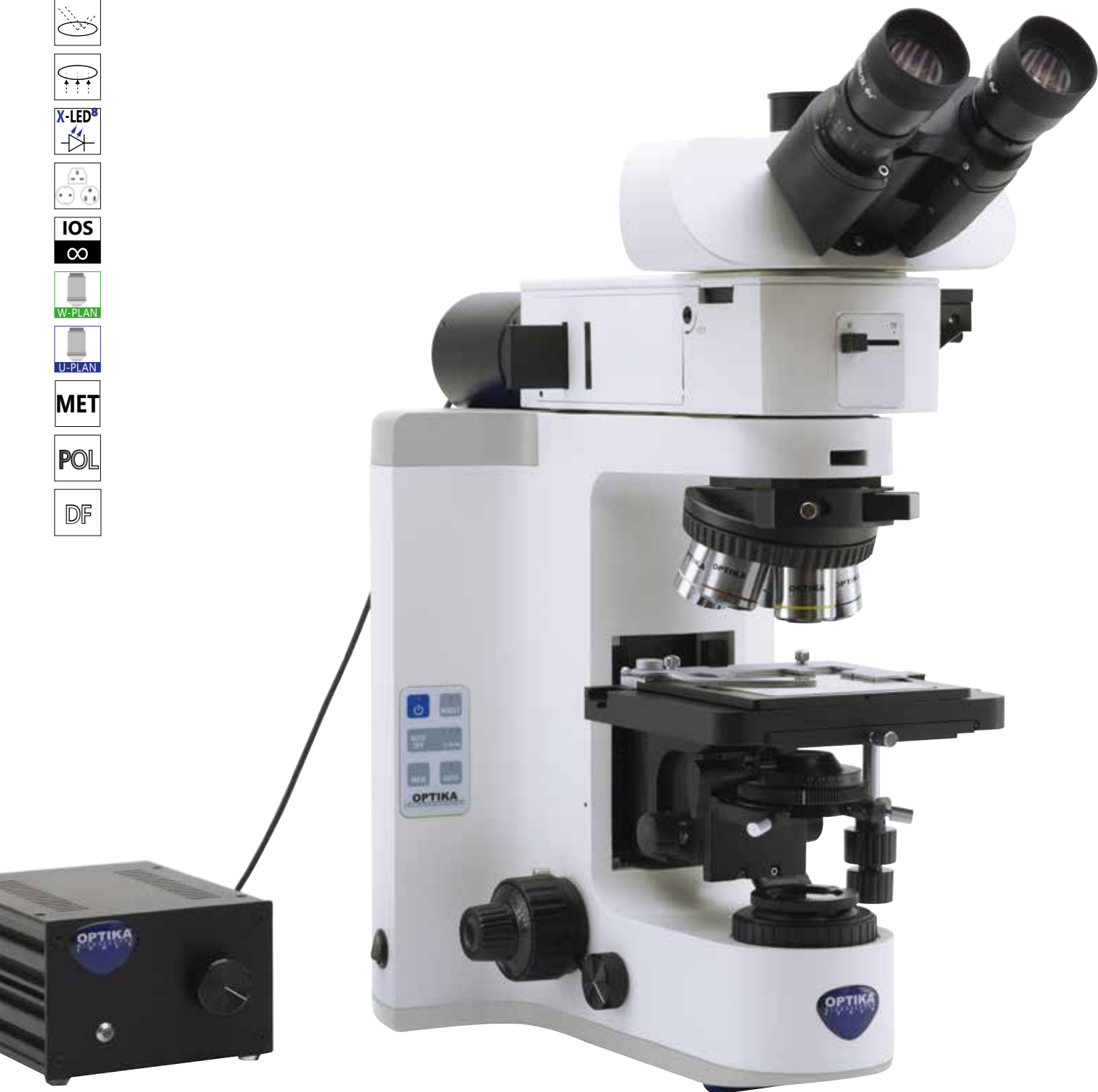

# B-1000MET - Configuration Chart

Build the microscope that suites your needs by choosing among the components



\* Code M-1156 must be added only **once** for any motorized configuration

# IM-3MET- Metallurgical Microscope

Routine inverted microscope with IOS LWD U-PLAN MET objectives for material science and metallographic applications, combining a sturdy yet compact structure with dedicated components required in this field, like the NCG (no cover glass) objectives working without cover slide ideal for metallographic samples and other opaque specimens. A particularly simple and ingenious optical design allows stable alignments and smooth and accurate movements.

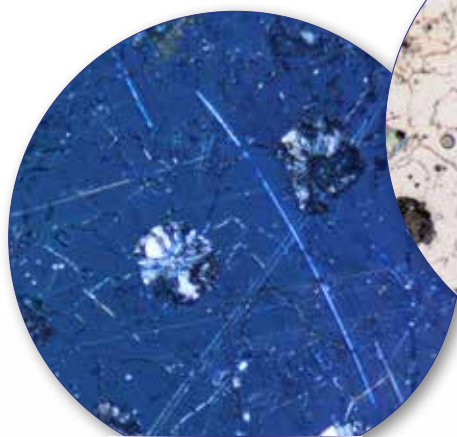

**CAST IRON  
POLARIZED LIGHT**

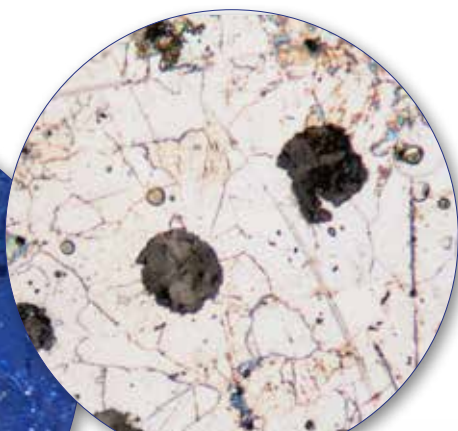

**CAST IRON  
BRIGHTFIELD**





# IM-3 Series - Specifications



Part	Description
<b>Observation mode:</b>	Brightfield, simple polarized light on incident light.
<b>Epi-illumination and polarizing filters:</b>	Halogen 12 V/50 W with brightness control. With aperture and field (centrable) diaphragms. With polarizer and analyzer.
<b>Head:</b>	Trinocular (2-position 100/0, 50/50), 45° inclined.
<b>Interpupillary distance:</b>	Adjustable between 50 and 75 mm.
<b>Dioptric adjustment:</b>	On the left eyepiece tube.
<b>Eyepieces:</b>	WF10x/22 mm, high eye-point and with rubber cups.
<b>Nosepiece:</b>	Quintuple revolving nosepiece, rotation on ball bearings.
<b>Objectives</b>	IOS LWD U-PLAN MET 5x/0.15 IOS LWD U-PLAN MET 10x/0.30 IOS LWD U-PLAN MET 20x/0.45 IOS LWD U-PLAN MET 50x/0.55 All with anti-fungus treatment.
<b>Specimen stage:</b>	Fixed stage, 250x160 mm, with metal stage insert.
<b>Focusing:</b>	Coaxial coarse (adjustable tension) and fine focusing mechanism with limit stop to prevent the contact between objective and specimen.

## IM-3 Series - Optical performance

Eyepiece	Field number (mm)	Objective	N.A.	W.D. (mm)	10x (M-780)		15x (M-601)	
					Total magnification	Field of view (mm)	Total magnification	Field of view (mm)
					22		16	
		5x	0.15	10.80	50x	4.40	75x	3.20
		10x	0.30	10	100x	2.20	150x	1.60
		20x	0.45	4	200x	1.10	300x	0.80
		50x	0.55	7.90	500x	0.44	750x	0.32
		100x	0.80	2.10	1000x	0.22	1500x	0.16

# IM-5MET - Metallurgical Microscope

Industrial and materials science inverted microscope especially designed for opaque specimens (including metals microstructure investigation and studies such as grain size, grain boundaries, phases, transformation, inclusions, and non-metals, as well as sample preparation and treatment) in metallography labs. Freely configurable lenses according to customer's preferences, FN 24 high eyepoint, infinity corrected optical system, coaxial focusing, mechanical stage, and epi-illumination attachment powered by halogen 12 V/100 W with brightness control. Sturdy and incredibly reliable, it is equipped with all the main controls in ergonomic position and with long lasting, efficient LED illumination to provide over 20 years of use.

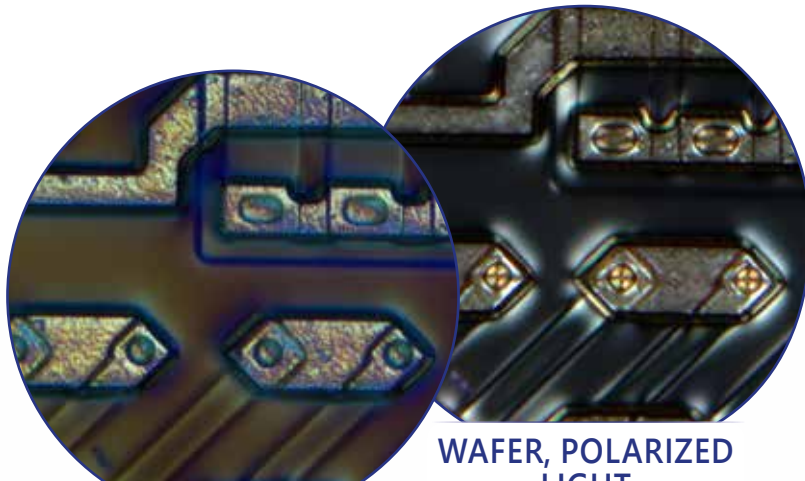

WAFER, DIC

WAFER, POLARIZED LIGHT



# IM-5MET - Specifications



Part	Description
<b>Head:</b>	Trinocular (split ratio: 100/0, 50/50), 45° inclined.
<b>Dioptric adjustment:</b>	Both eyepieces.
<b>Eyepieces:</b>	WF10x/24 mm, high eyepoint, secured by screw and with retractable rubber cups.
<b>Epi-illumination &amp; filters:</b>	Halogen 12 V/100 W with brightness control. With field and aperture diaphragms, polarizer and analyzer filters.
<b>Nosepiece:</b>	Quintuple ball bearings revolving nosepiece, reversed.
<b>Objectives:</b>	Selectable according to customer's preferences. All with anti-fungus treatment.
<b>Specimen stage:</b>	Mechanical stage, 240x250 mm.
<b>Focusing:</b>	Coaxial coarse and fine focusing mechanism with limit stop to prevent the contact between objective and specimen. Adjustable tension of coarse focusing knob.

## IM-5MET is freely configurable in terms of objectives, by choosing among:

Included ■ Optional □

MET Infinity-corrected Plan-Achromatic, Long Working Distance objectives, field flatness up to F.N. 25:		
M-1100	IOS LWD U-PLAN MET objective 5x/0.15	□
M-1101	IOS LWD U-PLAN MET objective 10x/0.30	□
M-1102	IOS LWD U-PLAN MET objective 20x/0.45	□
M-1103	IOS LWD U-PLAN MET objective 50x/0.55	□
M-1104	IOS LWD U-PLAN MET objective 100x/0.80 (dry)	□

MET Infinity-corrected Semi-Apochromatic, Long Working Distance objectives, field flatness up to F.N. 25:		
M-1171	IOS LWD U-PLAN F MET objective 5x/0.15	□
M-1172	IOS LWD U-PLAN F MET objective 10x/0.30	□
M-1173	IOS LWD U-PLAN F MET objective 20x/0.50	□
M-1174	IOS LWD U-PLAN F MET objective 50x/0.80	□
M-1175	IOS LWD U-PLAN F MET objective 100x/0.90 (dry)	□

MET Infinity-corrected Plan-Achromatic, Long Working Distance objectives, for brightfield and darkfield, field flatness up to F.N. 25:		
M-1094	IOS LWD U-PLAN MET BD objective 5x/0.15	□
M-1095	IOS LWD U-PLAN MET BD objective 10x/0.30	□
M-1096	IOS LWD U-PLAN MET BD objective 20x/0.45	□
M-1097	IOS LWD U-PLAN MET BD objective 50x/0.55	□
M-1098	IOS LWD U-PLAN MET BD objective 100x/0.80 (dry)	□

MET Infinity-corrected Semi-Apochromatic, Long Working Distance objectives, for brightfield and darkfield, field flatness up to F.N. 25:		
M-1180	IOS LWD U-PLAN F MET BD objective 5x/0.15	□
M-1181	IOS LWD U-PLAN F MET BD objective 10x/0.30	□
M-1182	IOS LWD U-PLAN F MET BD objective 20x/0.50	□
M-1183	IOS LWD U-PLAN F MET BD objective 50x/0.80	□
M-1184	IOS LWD U-PLAN F MET BD objective 100x/0.90 (dry)	□



v 1.4.0 - OPTIKA reserves the right to make corrections, modifications, enhancements, improvements and other changes to its products at any time without notice.

---

## Headquarters and Manufacturing Facilities

---

**OPTIKA® S.r.l.** Via Rigla, 30 - 24010 Ponteranica (BG) - ITALY - Tel.: +39 035.571.392 - [info@optikamicroscopes.com](mailto:info@optikamicroscopes.com)

### Optika Sales branches

---

**OPTIKA® Spain** [spain@optikamicroscopes.com](mailto:spain@optikamicroscopes.com)  
**OPTIKA® China** [china@optikamicroscopes.com](mailto:china@optikamicroscopes.com)  
**OPTIKA® India** [india@optikamicroscopes.com](mailto:india@optikamicroscopes.com)

**OPTIKA® USA** [usa@optikamicroscopes.com](mailto:usa@optikamicroscopes.com)  
**OPTIKA® Central America** [camerica@optikamicroscopes.com](mailto:camerica@optikamicroscopes.com)

# IS SERIES



**Inspection Video Microscopes**

## IS-02 - Overview

Advanced inspection system suitable for intensive use, ideal for video inspection in quality control of electronics, mechanics, and other industrial applications.

IS-02 includes the C-HAF **real-time full HD auto-focus camera** with **relevant zooming capabilities** (optical zoom is 1x...14x, electronic zoom is 1x...6x).

Crystal clear 1080p live view is shown through a large HD monitor, with incredibly fast connection (60 fps). Its angle of view is **fully adjustable** and it enables **instant focus** in less than 1 sec. with no need to constantly adjust lens position. In addition, the working distance goes to infinity, making it the **recommended solution to inspect multi-layered objects**.

All functions are controlled directly from the screen via a wireless mouse. Images and videos can be saved on the SD card and easily transferred on any device. The system is completed by the SZ-STLX **boom stand** with a **special joint to enable any rotation** (transversal and longitudinal): the longitudinal movement is through the sliding of the horizontal rail (lockable); whilst also the overall height is both adjustable and lockable.



Reduce inspection time with real-time focus from any angle



# IS-02 - Technical Specifications



## IS-02

### HDMI MONITOR

Type	LCD screen 360° rotating, freely inclinable for ergonomic vision
Size	11,5"
Power supply	12V / 2,5A

### CAMERA

HDMI camera resolution (MP)	2
Camera resolution (n° of pixels: W x H)	1920x1080
HDMI signal output	Yes
Trigger signal output	Yes
Sensor size	1/2.8"
Sensor technology	CMOS
Sensor type	SONY EXMOR
Optical zoom	1x-14x
Digital zoom	1x-6x
Rolling shutter	Yes
Autofocus	Yes
Image format	16/9
Pixel size (mm)	2.9x2.9

Frame rate full resolution (fps)	60@1920x1080
Camera power	5V 2A
Dimensions (mm)	88 x 72 x 125
Weight (Kg)	0.57

### STAND

Type	Coarse simple overhanging
Coarse total travel (mm)	50
Adjustable tension	Yes
Head holder internal diameter (mm)	76
Pillar diameter (mm)	32
Maximum sample height (mm)	270 (from bench)
Total height (mm)	430
Base height (mm)	58
Base width (mm)	210
Base depth (mm)	255
Horizontal arm (mm)	790
Product weight (kg)	16.3

### ACCESSORIES

Accessories Included:	Wireless mouse, 30 cm HDMI cable, 8 GB micro SD, Power supply
-----------------------	---

No need to constantly re-adjust the lens focus

On-board controls and cross grid

Working distance is between 10 cm and infinity, making it the ideal solution to inspect multi-layered and large objects

1/2.8" CMOS 2MP camera with powerful 1x-14x optical zoom (plus electronic zoom)

High-performance boom stand with special joint for customized camera positioning

Sliding horizontal rail for longitudinal positioning; adjustable longitudinal limit; adjustable and lockable height

Sensor's main features are the high sensitivity and incredible color fidelity: save money (no need of external illuminators or ring lights)

Wireless mouse and SD card are included

## IS-03 - Overview

Advanced inspection system suitable for intensive use, ideal for video inspection in quality control of electronics, mechanics, and other industrial applications.

IS-03 includes the C-HAF **real-time full HD auto-focus camera** with **relevant zooming capabilities** (optical zoom is 1x...14x, electronic zoom is 1x...6x).

Crystal clear 1080p live view is shown through a large HD monitor, with **incredibly fast connection** (60 fps). Its angle of view is **fully adjustable** and it enables **instant focus** in less than 1 sec. with no need to constantly adjust lens position. In addition, the working distance goes to infinity, making it the **recommended solution to inspect multi-layered objects**.

All functions are controlled directly from the screen via a wireless mouse. Images and videos can be saved on the SD card and easily transferred on any device. The system is completed by the **table clamping SZ-STL5 highly versatile flexible arm stand**, 360° rotating, ideal for high and large samples and on every bench thanks to its compact footprint, saving valuable space on the bench. A **wall mounting system** is also included.



Reduce inspection time with real-time focus from any angle

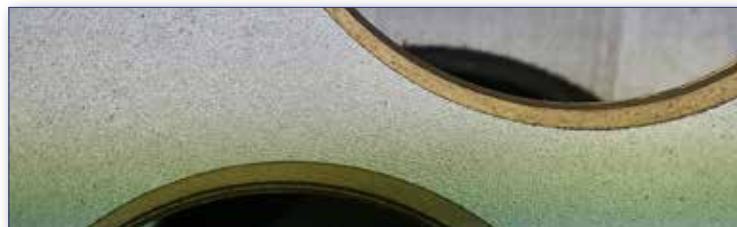



# IS-03 - Technical Specifications



## IS-03

### HDMI MONITOR

<b>Type</b>	LCD screen 360° rotating, freely inclinable for ergonomic vision
<b>Size</b>	11,5"
<b>Power supply</b>	12V / 2,5A

### CAMERA

<b>HDMI camera resolution (MP)</b>	2
<b>Camera resolution (n° of pixels: W x H)</b>	1920x1080
<b>HDMI signal output</b>	Yes
<b>Trigger signal output</b>	Yes
<b>Sensor size</b>	1/2.8"
<b>Sensor technology</b>	CMOS
<b>Sensor type</b>	SONY EXMOR
<b>Optical zoom</b>	1x-14x
<b>Digital zoom</b>	1x-6x
<b>Rolling shutter</b>	Yes
<b>Autofocus</b>	Yes
<b>Image format</b>	16/9
<b>Pixel size (mm)</b>	2.9x2.9
<b>Frame rate full resolution (fps)</b>	60@1920x1080

<b>Camera power</b>	5V 2A
<b>Dimensions (mm)</b>	88 x 72 x 125
<b>Weight (Kg)</b>	0.57

### STAND

<b>Type</b>	Coarse, Pantograph, with table and wall clamps
<b>Coarse total travel (mm)</b>	50
<b>Adjustable tension</b>	Yes
<b>Head holder internal diameter (mm)</b>	76
<b>Pillar diameter (mm)</b>	35
<b>Total height (mm)</b>	327
<b>Total width (mm)</b>	300
<b>Total depth (mm)</b>	800
<b>Horizontal arm (mm)</b>	737
<b>Product Weight (kg)</b>	5.1

### ACCESSORIES

<b>Accessories Included:</b>	Wireless mouse, 30 cm HDMI cable, 8GB micro SD and power supply
------------------------------	---

**No need to constantly re-adjust the lens focus**

1/2.8" CMOS 2MP camera with **powerful 1x-14x optical zoom** (plus electronic zoom)

**On-board controls** and cross grid

Working distance is **between 10 cm and infinity**, making it the ideal solution to inspect multi-layered and large objects

Sensor's main features are the **high sensitivity** and **incredible color fidelity**: save money (no need of external illuminators or ring lights)

**Small footprint to save valuable space** on the bench; **table-clamp and wall-mount**

**Freely orientable arm and joint**

Wireless mouse and SD card are included

## Real-time Full HD Auto-Focus Inspection Camera

**OPTIKA C-HAF** is a real-time full HD auto-focus inspection camera, with 2 MP resolution to view crystal clear **1080p** images/videos on HD monitor, through HDMI connection at **60 fps**. Its angle of view is **fully adjustable**.

Achieve **instant focus** without the need to constantly adjust your lens with the incredibly fast focusing system (acquisition time is lower than 1 sec.) without the inconvenience of having to constantly re-adjust the lens focus.

Working distance is between 10cm and infinity, making it the ideal solution to inspect multi-layered objects, extremely quickly. The camera is equipped with **1x-14x optical zoom** and 1x-6x electronic zoom.

All functions are controlled **directly from the screen**, with the support of mouse, and images and videos can be directly acquired on SD card (mouse and SD card are included).

### Main functions are:

- Possibility to perform automatic or manual white balance, independently setting RGB parameters for a perfect color reproduction
- Choose between automatic or manual exposure
- With HDR function, a sequence of images is captured at different exposures, and they are combined into a single image
- Trigger function allows the connection with an external controller and the file acquisition is possible with a determined sequence
- Possibility to set horizontal and vertical lines, in different colors and positions, to generate a custom grid directly on the HDMI screen

OPTIKA C-HAF comes with fixing holes to be connected with "custom" supports or brackets.

It is available also combined with a boom stand (as **IS-02**) or a compact stand with table clamp or wall-mount (as **IS-03**).



Reduce inspection time with real-time focus from any angle

# C-HAF - Technical Specifications

No need to constantly re-adjust the lens focus.



1/2.8" CMOS 2MP camera with **powerful 1x-14x optical zoom** (plus electronic zoom)

## C-HAF

### CAMERA

<b>HDMI camera resolution (MP)</b>	2
<b>Camera resolution (n° of pixels: W x H)</b>	1920x1080
<b>HDMI signal output</b>	Yes
<b>Trigger signal output</b>	Yes
<b>Sensor size</b>	1/2.8"
<b>Sensor technology</b>	CMOS
<b>Sensor type</b>	SONY EXMOR
<b>Optical zoom</b>	1x-14x
<b>Digital zoom</b>	1x-6x
<b>Rolling shutter</b>	Yes
<b>Autofocus</b>	Yes
<b>Image format</b>	16/9
<b>Pixel size (mm)</b>	2.9x2.9
<b>Frame rate full resolution (fps)</b>	60@1920x1080
<b>Camera power</b>	5V 2A
<b>Dimensions (mm)</b>	88 x 72 x 125
<b>Weight (Kg)</b>	0.57

Sensor's main features are the **high sensitivity** and **incredible color fidelity**: save money (no need of external illuminators or ring lights)



**Working distance is between 10 cm and infinity**, making it the ideal solution to inspect multi-layered and large objects



**On-board controls** and cross grid

Wireless mouse and SD card are included



v 1.4.0 - OPTIKA reserves the right to make corrections, modifications, enhancements, improvements and other changes to its products at any time without notice.

---

## Headquarters and Manufacturing Facilities

---

**OPTIKA® S.r.l.** Via Rigla, 30 - 24010 Ponteranica (BG) - ITALY - Tel.: +39 035.571.392 - [info@optikamicroscopes.com](mailto:info@optikamicroscopes.com)

## Optika Sales branches

---

**OPTIKA® Spain** [spain@optikamicroscopes.com](mailto:spain@optikamicroscopes.com)  
**OPTIKA® China** [china@optikamicroscopes.com](mailto:china@optikamicroscopes.com)  
**OPTIKA® India** [india@optikamicroscopes.com](mailto:india@optikamicroscopes.com)

**OPTIKA® USA** [usa@optikamicroscopes.com](mailto:usa@optikamicroscopes.com)  
**OPTIKA® Central America** [america@optikamicroscopes.com](mailto:america@optikamicroscopes.com)



















## **CAMERAS & DIGITAL Solutions**

Cameras for Microscopy & Digital Scanner

# 4 CAMERAS & DIGITAL Solutions

<b>USB CAMERAS</b> - B Series	page 375
<b>USB CAMERAS &amp; TABLETS PC</b> - TB Series	page 378
<b>USB CAMERAS</b> - PRO Series	page 380
PRO Series Cooled	page 384
<b>HDMI CAMERAS</b> - H Series	page 386
<b>HDMI CAMERAS &amp; SCREEN</b> - H Series	page 388
<b>HDMI AUTO-FOCUS CAMERAS</b> - C-HA	page 390
<b>WiFi &amp; USB CAMERA</b> - 4083.WiFi	page 392
<b>EYEPIECE CAMERAS</b> - Educam & VC Series	page 394
<b>OPTICAL ADAPTERS</b> - Adapters for OPTIKA Cameras and Microscopes	page 396
<b>OPTIKA SOFTWARE</b> - Microscopy Analysis Software Suite	page 397
<b>OPTISCAN</b> - Digital Slide Scanner	page 405

## Icons

	Multi-Plug low voltage power supply		USB 2.0 input (mouse)		HDMI output
	Li-Ion Rechargeable battery		USB 2.0 output		SD/MicroSD slot
	CCD sensor		USB 3.0 output		Wi-Fi
	CMOS sensor		Tablet screen size		BlueTooth
	Camera resolution		Software included		Mouse included
	Cooling system				

# Microscope Cameras



**MICROSCOPE CAMERAS**

## C-B1 / C-B3 / C-B5 / C-B10



**USB user-friendly** cameras for **general purposes**.  
Superb results and vivid details from standard to high resolution

C-B1	C-B3	C-B5	C-B10
1.3 MP	3.1 MP	5.1 MP	10 MP
CMOS			

### USB 2.0 C-Mount and Eyepiece Microscope Cameras For General Purposes

Cameras have become indispensable nowadays and OPTIKA is offering a line of remarkable solutions for digital imaging. OPTIKA B Series represents a cost-effective solution equipped with the latest technology sensors with more vivid colors and great contrast for stunning images. This series features Aptina CMOS sensor with excellent color reproduction, significantly high frame rates and several resolutions available to match any customer need. Thanks to the convenience and simplicity, being extremely intuitive to install and operate, the OPTIKA B Series is recommended for educational and routine microscopes, also as eyepiece cameras (no need for additional adapters/rings in case of monocular and binocular microscopes). Software included (for Windows): Optika Vision Lite, Optika LiteView and Optika ProView. Optika LiteView is also compatible with IOS & Linux.

## USB CAMERAS - B Series - Specifications

	C-B1	C-B3
<b>Digital camera resolution</b>	1.3 MP (1280 x 1024)	3.1 MP (2048 x 1536)
<b>Signal output</b>	USB 2.0	USB 2.0
<b>Sensor Size</b>	1/3"	1/2"
<b>Sensor technology</b>	CMOS	CMOS
<b>Sensor type</b>	Aptina CMOS	Aptina CMOS
<b>Image format</b>	5/4	4/3
<b>Pixel size</b>	3.6 x 3.6 μm	3.2 x 3.2 μm
<b>Frame rate full resolution</b>	15 fps (1280 x 1024)	12 fps (2048 x 1536)
<b>Frame rate other resolutions</b>	50 fps (320 x 256)	32 fps (1024 x 768); 45 fps (680 x 510)
<b>Sensitivity</b>	1 V/lux-second	1 V/lux-second
<b>Signal / noise ratio</b>	44 dB	43 dB
<b>Dynamic range</b>	74 dB	61 dB
<b>ADC conversion</b>	8 Bit	8 Bit
<b>Color Depth</b>	1 Bit; 4 Bit; 8 Bit; 24 Bit	1 Bit ; 4 Bit; 8 Bit; 24 Bit
<b>Exposure Time</b>	0.14 msec - 2 sec	0.244 msec - 2 sec
<b>Binning</b>	1x1; 2x2; 4x4	1x1; 2x2; 3x3
<b>IR filter</b>	380-650 nm (IR-cut filter)	380-650 nm (IR-cut filter)
<b>Camera power</b>	PC USB	PC USB
<b>C-mount</b>	YES	YES

**Accessories included:** C-mount projection lens, 30 mm / 30.5 mm ring adapters, calibration slide, 1.8 m USB cable.



# USB CAMERAS - B Series

Easy to install either on trinocular head or on monocular/binocular microscopes

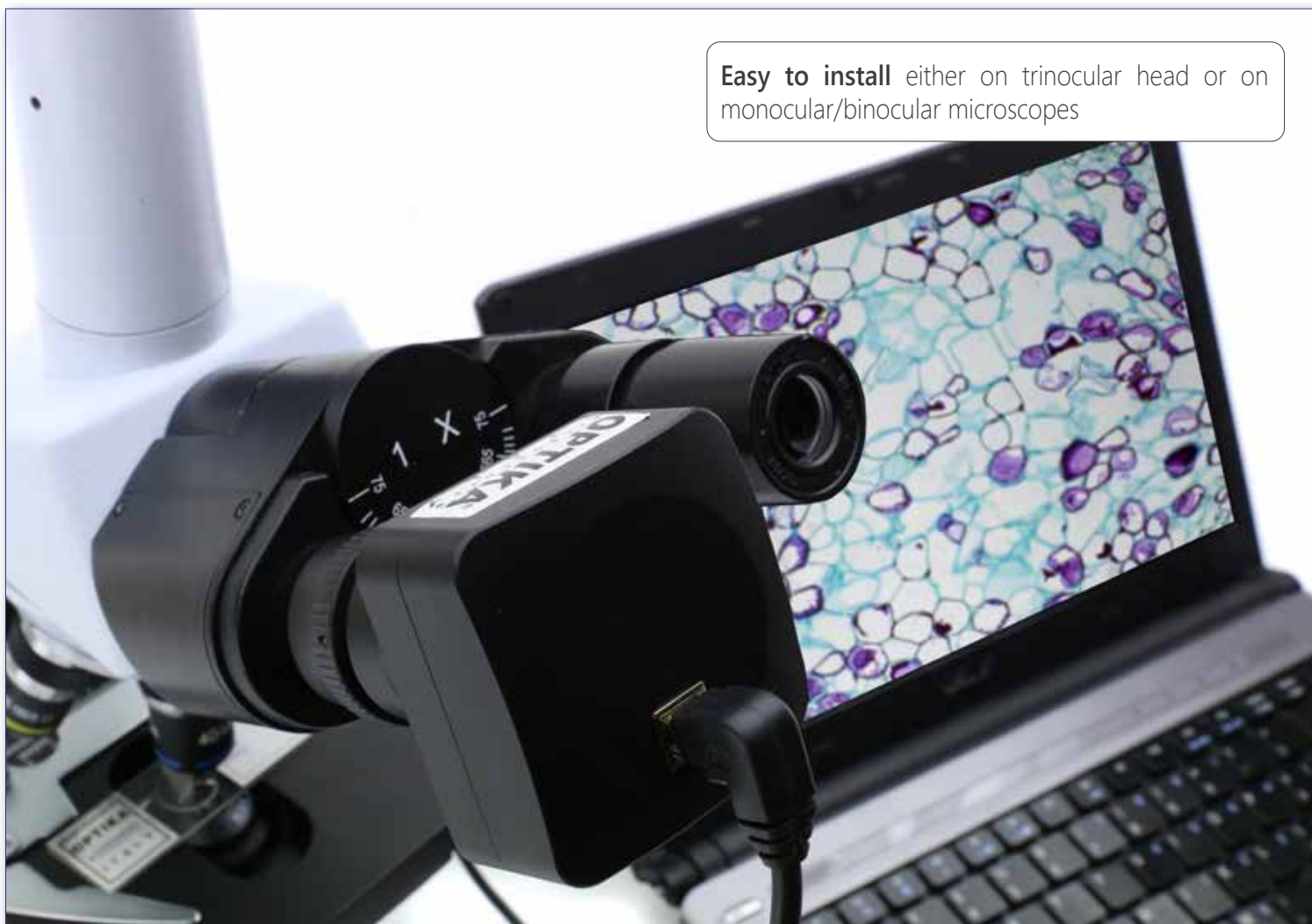

## C-B5

5.1 MP (2592 x 1944)
USB 2.0
1/2.5"
CMOS
Aptina CMOS
4/3
2.2 x 2.2 µm
7 fps (2592 x 1944)
27 fps (1280 x 960); 90fps (640 x 480)
0.53 V/lux-second
40.5 dB
66.5 dB
8 Bit
1 Bit; 4 Bit; 8 Bit; 24 Bit
0.294 msec - 2 sec
1x1; 2x2; 4x4
380-650 nm (IR-cut filter)
PC USB
YES

## C-B10

10 MP (3584 x 2748)
USB 2.0
1/2.3"
CMOS
Aptina CMOS
4/3
1.67 x 1.67 µm
3.3 fps (3584 x 2748)
11 fps (1792 x 1374); 38 fps (896 x 684)
0.31 V/lux-second
34 dB
65.2 dB
8 Bit
1 Bit; 4 Bit; 8 Bit; 24 Bit
0.4 msec - 2 sec
1x1; 2x2; 4x4
380-650 nm (IR-cut filter)
PC USB
YES



# 4 USB CAMERAS & TABLETS PC - TB Series



## Unique Features

- » Simultaneous camera & power connection
- » Equipped with the latest Windows OS & Intel processor
- » Easily detachable, can be used as a laptop (keyboard included)

## USB 2.0 C-Mount Microscope Cameras with Windows Tablet PC For Unparalleled Comfort & Performance

Exclusive tablet PC, powerful and versatile for a great user experience. Always one step forward to ensure the latest technology!

- A 2-in-1 solution that you can use like a PC, being Windows-based
- Powerful Intel processor ensuring top performance and speed
- High-resolution, vivid color graphic display
- Large touch screen of 10.1" with fast, responsive and smooth control
- Attached camera available in 3.1 MP (TB-3W) or 5.1 MP (TB-5W) resolution
- Includes the user-friendly and intuitive Optika ProView software
- C-mount connection for trinocular microscopes only

## TB-3W

## TB-5W

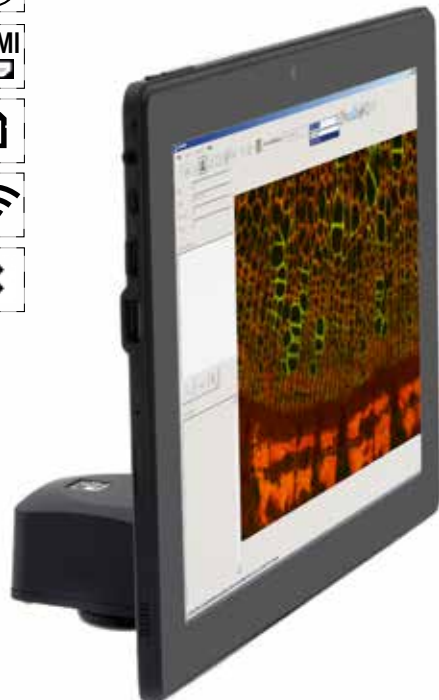
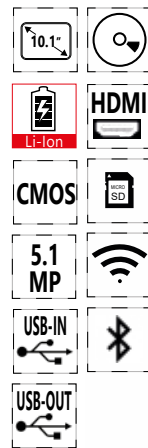
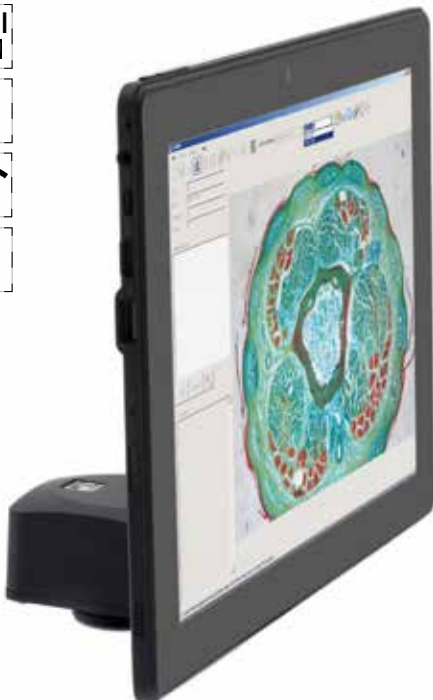
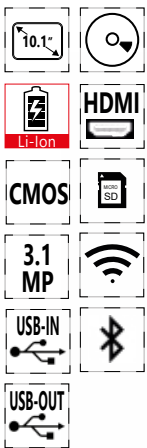

Windows tablet PC with large **10.1" LCD touch screen**, combined with a **3.1 MP camera** to create the most advanced solution for digital microscopy.

Windows tablet PC with large **10.1" LCD touch screen**, combined with a **5.1 MP camera** to create the most advanced solution for digital microscopy.

# USB CAMERAS & TABLETS PC - TB Series



Perform linear measurement on your image with **Optika ProView** just by drawing a line!



## TABLET TECHNICAL SPECIFICATIONS

<b>Operating system</b>	Windows 10 (64Bit)
<b>CPU</b>	Intel® Atom™ Z8350, Quad core
<b>CPU speed</b>	1.44 GHz
<b>Graphic card</b>	Intel® HD Graphics 400
<b>RAM</b>	Ram 4 GB LPDDR3
<b>Display size</b>	LED 10.8" IPS Multi Touch Screen
<b>Display resolution</b>	1920x1200
<b>Storage</b>	Hdd 64 GB
<b>Network</b>	Wireless - Bluetooth 4.0
<b>Input ports</b>	Micro USB - USB - Micro SD card reader
<b>Output ports</b>	Microphone - Headphone - Micro HDMI
<b>Battery Type</b>	Lithium-ion
<b>Battery capacity</b>	6500 mAh
<b>Power consumption</b>	15W
<b>Power supply</b>	5V 3A
<b>Dimensions (mm)</b>	261 X 167 X 9 mm
<b>Weight (Kg)</b>	0.53 kg
<b>Language</b>	Multilanguage

## CAMERA TECHNICAL SPECIFICATIONS

	<b>TB-3W</b>	<b>TB-5W</b>
<b>Digital camera resolution</b>	3.1 MP (2048 x 1536)	5.1 MP (2592 x 1944)
<b>Signal output</b>	USB 2.0	USB 2.0
<b>Sensor Size</b>	1/2"	1/2.5"
<b>Sensor technology</b>	CMOS	CMOS
<b>Sensor type</b>	Aptina CMOS	Aptina CMOS
<b>Image format</b>	4/3	4/3
<b>Pixel size</b>	3.2 x 3.2 µm	2.2 x 2.2 µm
<b>Frame rate full resolution</b>	12 fps (2048 x 1536)	7 fps (2592 x 1944)
<b>Frame rate other resolutions</b>	32 fps (1024 x 768); 45 fps (680 x 510)	27 fps (1280 x 960); 90fps (640 x 480)
<b>Sensitivity</b>	1 V/lux-second	0.53 V/lux-second
<b>Signal / noise ratio</b>	43 dB	40.5 dB
<b>Dynamic range</b>	61 dB	66.5 dB
<b>ADC conversion</b>	8 Bit	8 Bit
<b>Color Depth</b>	1 Bit ; 4 Bit; 8 Bit; 24 Bit	1 Bit; 4 Bit; 8 Bit; 24 Bit
<b>Exposure Time</b>	0.244 msec - 2 sec	0.294 msec - 2 sec
<b>Binning</b>	1x1; 2x2; 3x3	1x1; 2x2; 4x4
<b>IR filter</b>	380-650 nm (IR-cut filter)	380-650 nm (IR-cut filter)
<b>Camera power</b>	PC USB	PC USB
<b>C-mount</b>	YES	YES

**Accessories included:** C-mount projection lens, calibration slide, 1.8 m USB cable , keyboard with touchpad and touch pen.

# 4 USB CAMERAS - PRO Series

## C-P3 / C-P6 / C-P8



C-P3	C-P6	C-P8
3.1 MP	6.3 MP	8.3 MP
CMOS		USB-OUT

### High-Performance USB 3.0 C-Mount Microscope Cameras For General Purposes With High FPS

Do you require a high-end camera with an especially high resolution, generous dynamic range, rapid read-out rate and a USB3.0 port?

If your answer is yes, then the PRO series is your choice. Its compact and elegantly designed housing conceals the very latest in camera technology. Your images will be of the highest quality and rich in contrast and detail. OPTIKA PRO Series includes a wide range, to virtually fulfill each application demand.

Top-class SONY sensors, worldwide recognized, ensure you to capture your specimen in beautiful true-to-life color, delivering incredibly accurate colors just as you see them.

Software included (for Windows): Optika Vision Lite, Optika LiteView and Optika ProView. Optika LiteView is also compatible with IOS & Linux.

Professional cameras with high sensitivity, low noise and impressive capabilities in special applications (on different observation methods)

## USB CAMERAS - PRO Series - Specifications

	C-P3	C-P6	C-P8
Digital camera resolution	3.1 MP (2048 x 1536)	6.3 MP (3072 x 2048)	8.3 MP (3840 x 2160)
Signal output	USB 3.0	USB 3.0	USB 3.0
Sensor Size	1/2.8"	1/1.8"	1/2.5"
Sensor technology	CMOS	CMOS	CMOS
Sensor type	SONY EXMOR CMOS	SONY EXMOR CMOS	SONY EXMOR CMOS
Image format	4/3	3/2	16/9
Pixel size	2.5 x 2.5 µm	2.4 x 2.4 µm	1.62 x 1.62 µm
Frame rate full resolution	50 fps (2048 x 1536)	30 fps (3072 x 2048)	32 fps (3840 x 2160)
Frame rate other resolutions	50 fps (1920 x 1080)	38 fps (1536 x 1024)	65 fps (1920 x 1080)
Sensitivity	600 mV at 1/30sec	425 mV at 1/30sec	236 mV at 1/30sec
Dark signal	0.15 mV at 1/30sec	0.15 mV at 1/30sec	0.1 mV at 1/30sec
ADC Conversion	8 Bit - 12 Bit	8 Bit - 12 Bit	8 Bit - 12 Bit
Color Depth	1 Bit; 4 Bit; 8 Bit; 24 Bit	1 Bit; 4 Bit; 8 Bit; 24 Bit	1 Bit; 4 Bit; 8 Bit; 24 Bit
Exposure Time	0.1 msec - 15 sec	0.1 msec - 15 sec	0.1 msec - 15 sec
Binning	1x1	1x1; 2x2	1x1; 2x2
IR filter	380-650 nm (IR-cut filter)	380-650 nm (IR-cut filter)	380-650 nm (IR-cut filter)
Camera power	PC USB	PC USB	PC USB
C-mount	YES	YES	YES

Accessories included: calibration slide, 1.8 m USB cable.

# USB CAMERAS - PRO Series

## 4083.F33

**4083.F33**

### USB 3.0 C-Mount Microscope Camera With High FPS

Excellent color reproduction, with high frame rates, the OPTIKA 4083.F33 represents a valuable choice in routinary microscopy. Software included (for Windows): Optika Vision Lite

Achieve professional results and outstanding images with PRO Series: incredibly sharp and high contrast images also when combined to a stereomicroscope



OPTIKAM FAST3 4083.F33

### 4083.F33

3 MP

USB 3.0

1/2.7"

CMOS

ISP Integrated Chip

16/9

3.0x3.0  $\mu\text{m}$

30 fps (1920x1080)

7 fps (2304x1936)

1.275 V/lux-sec (550 nm)

na

8 Bit

8 Bit

330 msec

1x1; 2x2

700 nM

PC USB

YES

**Accessories included:** calibration slide, 1.8 m USB cable.



# 4 USB CAMERAS - PRO Series

## C-P6FL



### High-Performance USB 3.0 C-Mount Microscope Cameras For Special Applications

High grade SONY EXView HAD CCD sensor camera with 6.0 MP resolution recommended for special applications thanks to the impressive capabilities in the most challenging working conditions and featuring high sensitivity, low noise and USB 3.0 connection.

Software included (for Windows): Optika Vision Lite, Optika LiteView and Optika ProView. Optika LiteView is also compatible with IOS & Linux.

**High-performance CCD** camera for special applications. Recommended for **professional microscopes**, routine and research level (on different observation methods)



## USB CAMERAS - PRO Series - Specifications

	C-P6FL
Digital camera resolution	6 MP (2748 x 2200)
Signal output	USB 3.0
Sensor Size	1"
Sensor technology	CCD
Sensor type	SONY ExView HAD
Image format	5/4
Pixel size	4.54 x 4.54 μm
Frame rate full resolution	7.5 fps (2748 x 2200)
Frame rate other resolutions	14 fps (2748 x 1092)
Sensitivity	1000 mV at 1/30sec
Dark signal	8 mV at 1/30sec
ADC Conversion	8 Bit - 14 Bit
Color Depth	1 Bit; 4 Bit; 8 Bit; 24 Bit
Exposure Time	0.06 msec - 1000 sec
Binning	1x1
IR filter	380-650 nm (IR-cut filter)
Camera power	PC USB
C-mount	YES

Several focusable C-mount adapters available



Accessories included: calibration slide, 1.8 m USB cable.

# USB CAMERAS - PRO Series

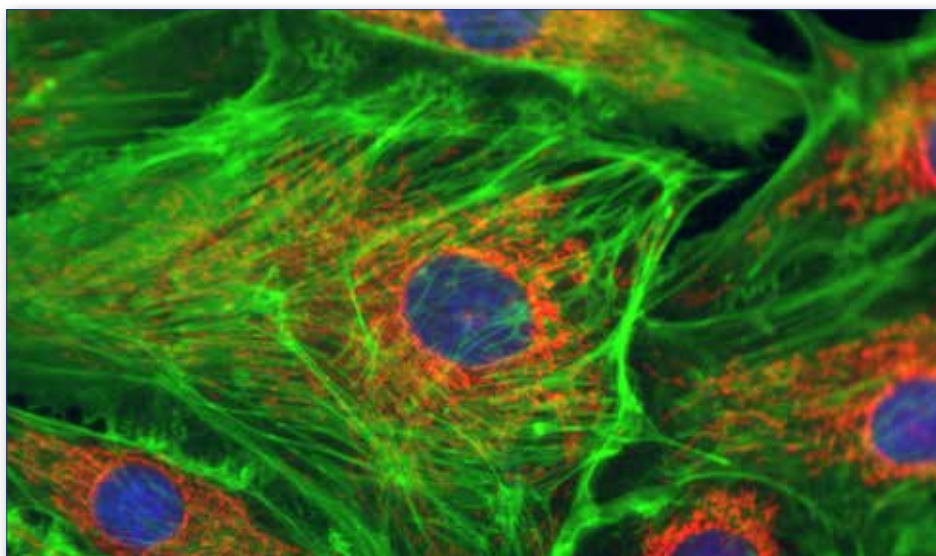

CCD sensor ensures significant and **impressive quality** on special techniques, **including fluorescence**.

**Non-cooled high-performance CCD camera.** Thanks to its very high sensitivity, it's **perfect for fluorescence microscopy**.



# 4 USB CAMERAS - PRO Series Cooled

## C-P20CC / C-P20CM



### Ultra High-Performance USB 3.0 C-Mount Cooled Microscope Cameras For Special Applications

For special applications, and requiring different observation methods, high sensor size cameras are preferred for the high sensitivity delivering high signal-to-noise ratio (low noise is achieved via cooling) and a large dynamic range. OPTIKA Pro Cooled cameras provide an excellent sensitivity. Peltier-cooled (cooling to 45°C below ambient), with scientific grade CMOS sensor, they ensure great performance in low light conditions, ultra-long exposure time and an impressive reliable color fidelity.

Software included (for Windows): Optika Vision Lite, Optika LiteView and Optika ProView. Optika LiteView is also compatible with IOS & Linux.



## USB CAMERAS - PRO Series Cooled - Specifications

	C-P20CC (Color)	C-P20CM (Monochrome)
Digital camera resolution	20 MP (5440 x 3648)	20 MP (5440 x 3648)
Signal output	USB 3.0	USB 3.0
Sensor Size	1"	1"
Sensor technology	CMOS	CMOS
Sensor type	SONY EXMOR	SONY EXMOR
Image format	3/2	3/2
Pixel size	2.4 x 2.4 μm	2.4 x 2.4 μm
Frame rate full resolution	5 fps (5440 x 3648)	17.8 fps (5440 x 3648)
Frame rate other resolutions	10 fps (4096 x 2160); 15 fps (2736 x 1824); 30 fps (1824 x 1216)	41 fps (4096 x 2160); 51 fps (2736 x 1824); 64 fps (1824 x 1216)
Sensitivity	426mV at 1/30sec	388mV at 1/30sec
Dark Signal	0.21mV at 1/30sec	0.21mV at 1/30sec
Cooling System	Internal two-stage TE cooling system -45°C	Internal two-stage TE cooling system -45°C
ADC conversion	8 Bit - 14 Bit	14 Bit
Color Depth	1 Bit; 4 Bit; 8 Bit; 24 Bit	1 Bit; 4 Bit; 8 Bit; 24 Bit
Exposure Time	0.1 msec - 3600 sec	0.1 msec - 3600 sec
Binning	1x1; 2x2; 3x3	1x1; 2x2; 3x3
IR filter	380-650 nm (IR-cut filter)	380-650 nm (IR-cut filter)
Camera power	PC USB	PC USB
C-mount	YES	YES

Accessories included: calibration slide, 1.8 m USB cable, power supply for cooling system.



# USB CAMERAS - PRO Series Cooled



Durable and safe reinforced plastic case to protect and store your valuable camera

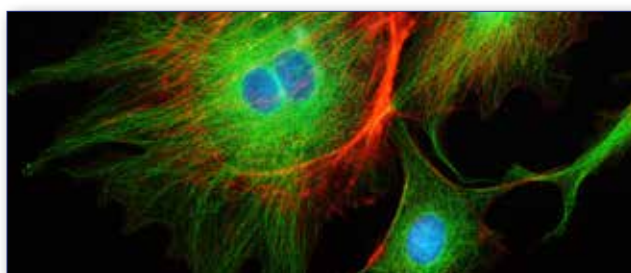

Achieve unparalleled results and superb images on special techniques, including fluorescence, with the latest technology **SONY EXMOR** sensors.



# 4 HDMI CAMERAS - H Series

## C-HE



### C-Mount & Eyepiece HDMI Microscope Camera For Easy Operation On Screens, No Compromises In Quality

- Aptina CMOS sensor with excellent color reproduction for routine applications
- C-mount connection, eyepiece adapter available on request
- No installation of software required when used in HDMI mode
- HDMI (2 MP, 1280 x 720) camera for screen connection
- Extremely reliable color fidelity
- Lightweight cameras, to be used even on the smallest and lightest microscopes
- SD card enables image and video capturing
- Built-in function buttons for HDMI camera control

720p HD high-speed microscope camera with Aptina CMOS sensor: intuitive, entry-level



## C-HP

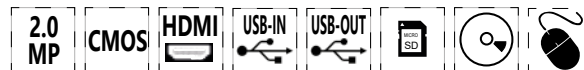

### C-Mount & Eyepiece High-Performance HDMI / USB Microscope Camera For Professional Use On Screens & PC, With Maximum Flexibility

- High grade SONY CMOS sensor for reliable colors
- C-mount connection, eyepiece adapter available on request
- No installation of software required when used in HDMI mode
- HDMI FULL HD (2 MP, 1920 x 1080) camera for screen connection and USB camera for PC use
- Reliable color fidelity
- Highly recommended for wide range of applications
- SD card enables image and video capturing
- Software included (for Windows): Optika ProView

Professional 1080p FULL HD high-speed microscope camera with measurement functions for premium performance



# HDMI CAMERAS - H Series



World-class viewing experience for **crystal-clear videos and image**

## HDMI CAMERAS - H Series - Specifications

	C-HE	C-HP
Video resolution (USB output)	-	1920 x 1080 pixel
Video resolution (HDMI output)	HD 720p	Full HD 1080p
Digital camera resolution	2 MP (1280 x 720)	2 MP (1920 x 1080)
Signal output	HDMI	HDMI
Sensor Size	1/2.8"	1/1.9"
Sensor technology	CMOS	CMOS
Sensor type	APTINA	SONY
Image format	16/9	16/9
Pixel size	2.8 x 2.8 $\mu\text{m}$	3.75 x 3.75 $\mu\text{m}$
Frame rate (HDMI)	30 fps (1280 x 720 HDMI); 30 fps (1920 x 1080 Capture)	60 fps (1920 x 1080 HDMI); 26fps (1920 x 1080 USB)
Sensitivity	510 mV at 1/30sec	1120 mV at 1/30sec
Dark Signal	0.15mV at 1/30sec	0.15mV at 1/30sec
Exposure Time	0.06 msec - 1900 msec	0.34 msec - 4 sec
Binning	1x1	1x1
IR filter	380-650 nm (IR-cut filter)	380-650 nm (IR-cut filter)
Camera power	DC 12V 1A	DC 12V 1A
C-mount	YES	YES
White balance	Auto	Auto / Manual
Gain control	Manual	Auto / Manual
Exposure control	Auto / Manual	Auto / Manual

Accessories included: **C-HE:** 2 m HDMI cable, 16GB SD card, wireless mouse, power supply.

**C-HP:** Calibration slide, 1.8 m USB cable, 2 m HDMI cable, 16GB SD card, wireless mouse, power supply.

# 4 HDMI CAMERAS & SCREEN - H Series

## C-HESC



**C-Mount HDMI Microscope Camera With 11.5" Full HD LCD Screen, No Compromises In Quality**



- All-in-one: save space on the bench, with no need for external devices
- Feel free to tilt the screen and adjust the position to the preferred level, eliminating fatigue during observation
- Aptina CMOS sensor with excellent color reproduction for routine applications
- HDMI (2 MP, 1280 x 720) camera
- C-mount connection for trinocular microscopes only



## C-HPSC



**C-Mount High-Performance HDMI / USB Microscope Camera with 11.5" Full HD LCD Screen For Professional Use (also on PC), With Maximum Flexibility**



- All-in-one: save space on the bench, with no need for external devices
- Feel free to tilt the screen and adjust the position to the preferred level, eliminating fatigue during observation
- High grade SONY CMOS sensor for reliable colors
- HDMI FULL HD (2 MP, 1920 x 1080) camera for screen connection and USB camera for PC use
- Camera control panel shows exposure, gain, white balance, color adjustment, sharpness and noise control
- On-screen monitor toolbar shows measuring, mirror, comparison, zoom, freeze, cross & browser when using mouse control
- Software included (for Windows): Optika ProView
- C-mount connection for trinocular microscopes only



# HDMI CAMERAS & SCREEN - H Series



## HDMI CAMERAS & SCREEN - H Series - Specifications

	C-HESC	C-HPSC
Video resolution (USB output)	-	1920 x 1080 pixel
Video resolution (HDMI output)	HD 720p	Full HD 1080p
Digital camera resolution	2 MP (1280 x 720)	2 MP (1920 x 1080)
Signal output	HDMI	HDMI
Sensor Size	1/2.8"	1/1.9"
Sensor technology	CMOS	CMOS
Sensor type	APTINA	SONY
Image format	16/9	16/9
Pixel size	2.8 x 2.8 $\mu\text{m}$	3.75 x 3.75 $\mu\text{m}$
Frame rate (HDMI)	30 fps (1280 x 720 HDMI); 30 fps (1920 x 1080 Capture)	60 fps (1920 x 1080 HDMI); 26fps (1920 x 1080 USB)
Sensitivity	510 mV at 1/30sec	1120 mV at 1/30sec
Dark Signal	0.15mV at 1/30sec	0.15mV at 1/30sec
Exposure Time	0.06 msec - 1900 msec	0.34 msec - 4 sec
Binning	1x1	1x1
IR filter	380-650 nm (IR-cut filter)	380-650 nm (IR-cut filter)
Camera power	DC 12V 1A	DC 12V 1A
C-mount	YES	YES
White balance	Auto	Auto / Manual
Gain control	Manual	Auto / Manual
Exposure control	Auto / Manual	Auto / Manual

### MONITOR TECHNICAL SPECIFICATIONS

Size	11,5"
Power supply	12V / 2,5A
HDMI cable	50 cm

Accessories included: C-HE: 2 m HDMI cable, 16GB SD card, wireless mouse, power supply.  
C-HP: Calibration slide, 1.8 m USB cable, 2 m HDMI cable, 16GB SD card, wireless mouse, power supply.

# HDMI AUTO-FOCUS CAMERAS - C-HA

## C-HA



Equipped with the **state-of-the-art autofocus** system to ensure precise focusing in any condition and in **real time**



### C-Mount High-Performance Autofocusing HDMI Microscope Camera

A superb microscope camera with the state-of-the-art autofocus system, ensuring precise and ultra-fast automatic focus adjustment in any condition and in real time. Ideal to compensate the lack of parfocality of the microscope without any user effort.

- Aptina CMOS sensor with excellent color reproduction for routine applications
- HDMI FULL HD (2 MP, 1920 x 1080) camera for screen connection
- Camera control panel shows exposure, white balance, color adjustment and sharpness when using mouse control
- C-mount connection for trinocular microscopes only



## HDMI AUTO-FOCUS CAMERAS - C-HA - Specifications

	C-HA
Digital camera resolution	2 MP (1920 x 1080)
Signal output	HDMI
Sensor Size	1/2.8"
Sensor technology	CMOS
Sensor type	APTINA CMOS
Image format	16/9
Pixel size	2.9 x 2.9 $\mu$ m
Frame rate (HDMI)	50 fps (1920x1080)
Sensitivity	510 mV at 1/30 sec
Dark Signal	0.15 mV at 1/30 sec
Exposure Time	Auto
Binning	1x1
IR filter	YES
Camera power	5V 2A
C-mount	YES
CS-Mount	YES

Accessories included: 2 m HDMI cable, 16GB SD card, wireless mouse, power supply.



# HDMI AUTO-FOCUS CAMERAS - C-HA



Extremely simple and convenient use:  
**no need of focus adjustment!**

Compensates any lack of parfocality of the objectives

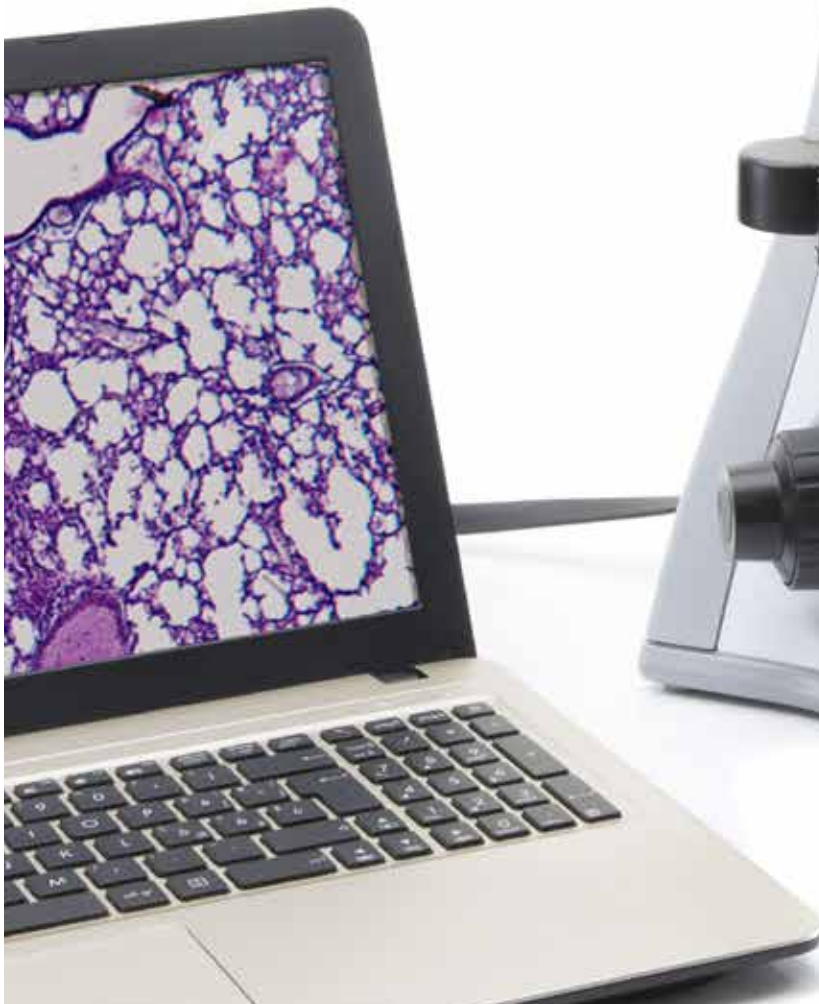

## 4 WIFI & USB CAMERA - 4083.WIFI

### 4083.WiFi



WiFi & USB 2.0 C-Mount and Eyepiece Microscope Camera Ideal For Teaching & Discussion Groups

- WiFi & USB connection modes
- 5 MP resolution on USB mode and 2 MP resolution on WiFi mode
- Ideal for educational applications with direct browser / IP connection
- No router is required
- Connectable to PC, smartphones, tablets and any other device
- Approx. 250 users connectable with good speed (speed depends on users connected)
- Supported by any device (PC, tablet or smartphone) with any type of browser (Chrome recommended)
- Lightweight cameras, to be used even on the smallest and lightest microscopes
- Image and video capturing function when used in WiFi mode
- Connection for both trinocular C-mount port and eyepiece tube
- Software included (for Windows): Optika Vision Lite, on USB mode



## WIFI & USB CAMERA - 4083.WIFI - Specifications

	<b>OPTIKAM WIFI 4083.WIFI</b>
PC camera resolution	5 MP
WiFi camera resolution	2 MP
Signal output	USB 2.0, WiFi
Sensor Size	1\2.5"
Sensor technology	CMOS
Image format	4\3
Full Image size	2592 x 1944
USB Frame rate Full resolution	3 fps (2592 x 1944)
USB Frame rate other resolutions	11 fps (640 x 480) 8 fps (1024 x 768)
WiFi Frame rate Low resolution	2 fps (640 x 480) with 10 users
WiFi Frame rate other resolutions	1 fps (1024 x 768) with 10 users 1 fps/3sec: (1600 x 1200) with 10 users
WiFi Speed	802.11n 150Mbps
WiFi Antenna	2.4GHz 5DB
Max Exposure time	Automatic
External camera power	5 V 2000mA
White Balance	Auto / Man
Gain Control	Auto / Man
Back light control	Auto / Man
Exposure control	Auto / Man
C-Mount connection	YES
CS-Mount connection	YES, ready

**Accessories included:** C-mount projection lens, 30 mm / 30.5 mm ring adapters, calibration slide, 1.8 m USB cable.

USB & WiFi camera in once.  
No router is required





# WIFI & USB CAMERA - 4083.WIFI



Share your live view with no limits!



# 4 EYEPIECE CAMERAS - Educam & VC Series

## Educam / VC-05

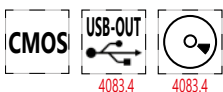

### EDUCAM - Multimedia cameras to meet various requirements in the educational field

- Direct connection to TV screen and monitor
- Versatile and flexible, yet sturdy and stable at the same time: can be used as overhead projector, for the projection of drawings, as a camera for teleconferences, assemblies, meetings or as a camera for filming
- Up to 90x magnifying power for any specimen and object
- 8mm objective lens enables focus from 0,76 cm, up to an infinite distance
- Extremely sensitive microphone to record voices/sounds (Multimedia models only)
- Includes the user-friendly and intuitive OPTIKA Vision Lite software

All models are equipped with two adapters for video-microscopy (for biological and stereo microscopes)

### VC-05 - Simple Eyepiece Microscope Camera With CCD Sensor, 420 TV Lines (PAL)



4083 - 4083.1 - 4083.2 - 4083.3

USB - 4083.4



MIC- 4083.5



VC-05

	MULTIMEDIA / 4083	MULTIMEDIA PRO / 4083.1	STUDENT / 4083.2	STUDENT PRO / 4083.3
Digital camera resolution	NO	NO	NO	NO
Analog camera resolution	PAL 582 x 420	PAL 582 x 420	PAL 582 x 420	PAL 582 x 420
Signal output	PAL	PAL	PAL	PAL
Audio Signal	Analog	Analog	NO	NO
Sensor Size	1/3"	1/3"	1/3"	1/3"
Sensor technology	CCD	CCD	CCD	CCD
Image format	4/3	4/3	4/3	4/3
Full Image size	-	-	-	-
Frame rate full resolution	50 frames/sec (analog mode)	50 frames/sec (analog mode)	50 frames/sec (analog mode)	50 frames/sec (analog mode)
Max Exposure time	-	-	-	-
ON board Memory	NO	NO	NO	NO
External Memory Card	NO	NO	NO	NO
External camera power	15V DC power supply	15V DC power supply	12V DC power supply	12V DC power supply
White Balance	Auto	Auto	Auto	Auto
Gain Control	Auto	Auto	Auto	Auto
Back light control	Auto	Auto	Auto	Auto
Exposure control	Auto	Auto	Auto	Auto
C-Mount connection	YES	YES	YES	YES
CS-Mount connection	NO	NO	NO	NO
Arm length	50 cm	65 cm	50 cm	65 cm
8mm objective	YES	YES	YES	YES

Accessories included:

All models (except VC-05 and C-E2): C-mount projection lens, 30 mm ring adapter, SCART for TV plug.

VC-05: C-mount projection lens, 30 mm / 30.5 mm ring adapters, SCART for TV plug.

C-E2: 30 mm / 30.5 mm ring adapters, 1.8 m USB cable.

## C-E2



### User-Friendly Eyepiece Microscope Camera

- Direct connection into the eyepiece tube (23 mm, 30 mm & 30.5 mm diameter)
- No additional adapters required
- Very useful for educational purposes
- Removable miniUSB cable
- Software included (for Windows): Optika Vision Lite, Optika LiteView and Optika ProView.
- Optika LiteView is also compatible with IOS & Linux.



Ready to use, replacing one eyepiece

USB / 4083.4	MIC / 4083.5	VC-05	C-E2
0.3 MP	NO	NO	2 MP
PAL 582 x 420	PAL 582 x 420	PAL 582 x 420	NO
PAL , USB2.0	PAL	PAL	USB 2.0
Analog	NO	NO	NO
1\3"	1\3"	1\3"	1\3.2"
CCD	CCD	CCD	CMOS
4\3	4\3	4\3	4\3
640 x 480	-	-	1600 x 1200
50 frames\sec (analog mode), 25 frames\sec (digital mode)	50 frames\sec (analog mode)	50 frames\sec (analog mode)	5 fps (1600x1200) / 7,5 fps (1280x1024) / 22fps (640x480)
Auto	-	-	Auto
NO	NO	NO	NO
NO	NO	NO	NO
15V DC power supply	12V DC power supply	12V DC power supply	PC USB
Auto	Auto	Auto	Auto
Auto	Auto	Auto	Auto
Auto	Auto	Auto	Auto
Auto	Auto	Auto	Auto
YES	YES	NO	NO
NO	NO	NO	NO
65cm	-	-	-
YES	YES	NO	NO

# OPTIKA ADAPTERS - Adapters for OPTIKA Cameras and Microscopes

## Upright/Inverted Microscopes (C-mount projection lens)



**M-115**  
(0.35x)



**M-114**  
(0.5x)

## Upright/Inverted Microscopes (Focusable C-mount adapter)



**M-620**  
(0.35x)



**M-620.1**  
(0.5x)



**M-620.2**  
(0.65x)



**M-620.3**  
(1x)

## Stereomicroscopes - SZM / SZO / SZP Series (Focusable C-mount adapter)



**ST-090**  
(0.35x)



**ST-090.1**  
(0.5x)



**ST-090.2**  
(0.65x)



**M-620.3**  
(1x)

Camera models	Sensor size	Upright				Inverted	Stereo		
		Monocular Binocular (Ø 23mm)	Trinocular (Ø 23mm)	Binocular (Ø 30mm)	Trinocular (Ø 30mm)	Trinocular (Ø 30mm)	Binocular (Ø 30.5mm)	Binocular (Ø 30mm)	Trinocular (Ø 30mm)
		Ecovision / B-60 B-150 / B-190 B-290 / B-380	B-190 / B-290	B-810 / B-1000	B-380 / B-510 B-810 / B-1000	IM-3 / IM-5	SFX	SLX / SZM / SZO SZP	SLX / SZM / SZO SZP
<b>C-B1</b>	1/3"	included with the camera	included with the camera	included with the camera	M-620	M-620	included with the camera	included with the camera	ST-090
<b>C-B3</b>	1/2"	included with the camera	included with the camera	included with the camera	M-620.1	M-620.1	included with the camera	included with the camera	ST-090.1
<b>C-B5</b>	1/2.5"	included with the camera	included with the camera	included with the camera	M-620.1	M-620.1	included with the camera	included with the camera	ST-090.1
<b>C-B10</b>	1/2.3"	included with the camera	included with the camera	included with the camera	M-620.1	M-620.1	included with the camera	included with the camera	ST-090.1
<b>C-HA</b>	1/2.8"	-	M-115	-	M-620	M-620	-	-	ST-090
<b>C-HE</b>	1/2.8"	M-115	M-115	M-115 + M-113.1	M-620	M-620	M-115 + M-113.2	M-115 + M-113.1	ST-090
<b>C-HESC</b>	1/2.8"	-	M-115	-	M-620	M-620	-	-	ST-090
<b>C-HP</b>	1/1.9"	M-114	M-114	M-114 + M-113.1	M-620.1	M-620.1	M-114 + M-113.2	M-114 + M-113.1	ST-090.1
<b>C-HPSC</b>	1/1.9"	-	M-114	-	M-620.1	M-620.1	-	-	ST-090.1
<b>C-P3</b>	1/2.8"	M-115	M-115	M-115 + M-113.1	M-620	M-620	M-115 + M-113.2	M-115 + M-113.1	ST-090
<b>C-P6</b>	1/1.8"	M-114	M-114	M-114 + M-113.1	M-620.1	M-620.1	M-114 + M-113.2	M-114 + M-113.1	ST-090.1
<b>C-P6FL</b>	1"	-	-	-	M-620.3	M-620.3	-	-	M-620.3
<b>C-P8</b>	1/2.5"	M-114	M-114	M-114 + M-113.1	M-620.1	M-620.1	M-114 + M-113.2	M-114 + M-113.1	ST-090.1
<b>C-P20CC</b>	1"	-	-	-	M-620.3	M-620.3	-	-	M-620.3
<b>C-P20CM</b>	1"	-	-	-	M-620.3	M-620.3	-	-	M-620.3
<b>TB-3W</b>	1/2"	-	included with the camera	-	M-620.1	M-620.1	-	-	ST-090.1
<b>TB-5W</b>	1/2.5"	-	included with the camera	-	M-620.1	M-620.1	-	-	ST-090.1
<b>4083.F33</b>	1/2.7"	M-115	M-115	M-115 + M-113.1	M-620	M-620	M-115 + M-113.2	M-115 + M-113.1	ST-090
<b>4083.WiFi</b>	1/2.5"	included with the camera	included with the camera	M-114 + M-113.1	M-620.1	M-620.1	included with the camera	included with the camera	ST-090.1

v 1.4.0 - OPTIKA reserves the right to make corrections, modifications, enhancements, improvements and other changes to its products at any time without notice.

## Headquarters and Manufacturing Facilities

**OPTIKA® S.r.l.** Via Rigla, 30 - 24010 Ponteranica (BG) - ITALY - Tel.: +39 035.571.392 - info@optikamicroscopes.com

## Optika Sales branches

**OPTIKA® Spain** spain@optikamicroscopes.com  
**OPTIKA® China** china@optikamicroscopes.com  
**OPTIKA® India** india@optikamicroscopes.com

**OPTIKA® USA** usa@optikamicroscopes.com  
**OPTIKA® Central America** camerica@optikamicroscopes.com

# OPTIKA SOFTWARE

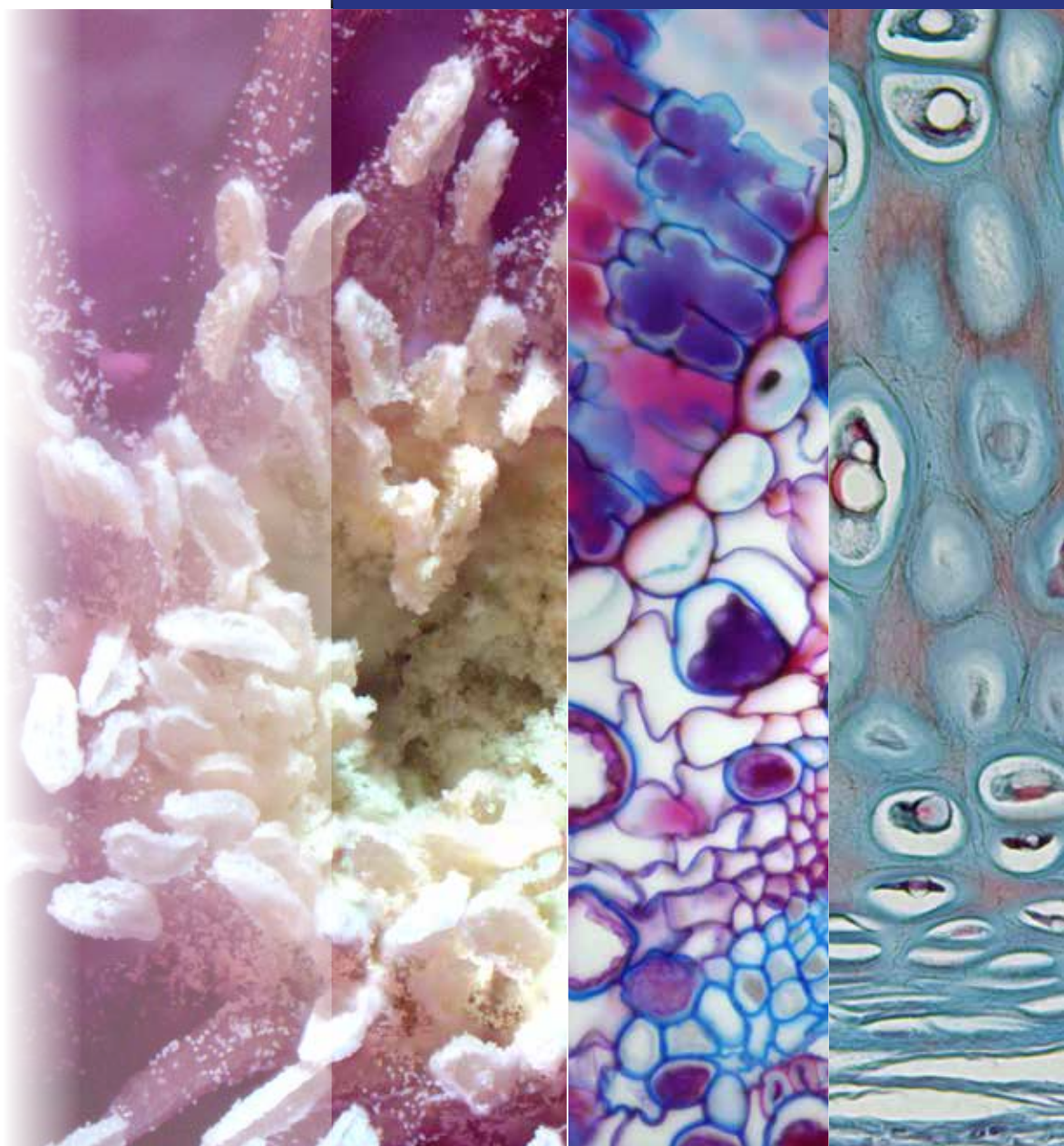

**OPTIKA SOFTWARE SUITES**

# OPTIKA SOFTWARE - Comparison chart

## Software

- Before proceeding with the SW installation, please check the table below "Software Function list" to identify the most suitable software.



## SOFTWARE FUNCTION LIST

FUNCTION		OPTIKA PRO VIEW	OPTIKA LITE VIEW	OPTIKA VISION LITE	
<b>GENERAL</b>	Simultaneous management of several cameras	X	X	X	
	GUI (Graphical User Interface)	X			
	Report generator	X		X	
	Archiving	X	X	X	
	Language	Catalan	X	X	
		Chinese (simpl.)	X	X	
		Chinese (trad.)	X	X	
		Korean	X	X	
		English	X	X	X
		French	X	X	X
		German	X	X	X
		Indonesian	X	X	
		Italian	X	X	X
		Japanese	X	X	
		Polish	X	X	X
		Russian	X	X	
	Spanish	X	X	X	
Swedish			X		
Thai	X	X			
Turkish	X	X			

FUNCTION		OPTIKA PRO VIEW	OPTIKA LITE VIEW	OPTIKA VISION LITE	
<b>MEASUREMENTS</b>	Measurements on "live"	X			
	Measurements on "captured"	X		X	
	2D Measurements	Line	X		X
		Angle	X		
		Parallel lines	X		
		Rectangle	X		
		Ellipse	X		
		Circle	X		
		Annulus	X		
		Arc	X		
		Curve	X		
	Polygon	X			
Particle count	X				
Export to Excel	X		X		

# OPTIKA SOFTWARE - Comparison chart

## SOFTWARE FUNCTION LIST

FUNCTION		OPTIKA PRO VIEW	OPTIKA LITE VIEW	OPTIKA VISION LITE	
IMAGE ACQUISITION	Simultaneous management of several cameras	X	X		
	IMAGE acquisition	X	X	X	
	Image formats	tiff	X	X	X
		jpg	X	X	X
		bmp	X	X	X
		png	X	X	
		pcx	X	X	
		jp2	X	X	
		dcm	X	X	
	IMAGE acquisition	X	X	X	
	VIDEO formats	avi	X	X	X
		wmv	X	X	X
		mp4	X	X	X
		asf	X	X	X
		3gp	X	X	X
		mov	X	X	X
		h264	X	X	X
		h265	X	X	X
	Continuous automatic exposure	X	X	X	
	Manual Exposure	X	X	X	
	Mobile spot for exposure	X	X	X	
	Resizable spot for exposure	X	X	X	
	Colour acquisition	X	X	X	
	Grey-scale acquisition	X	X	X	
	Manual Time-Lapse	X		X	
	Automatic Time-Lapse	X			
	Fast Image Acquisition	X	X	X	
	Focus Indicator	X			
	White Balance	X	X	X	
	Black balance	X			
Background correction	X				
Dark Field Correction	X	X			
Image Enhancement	X	X	X		
Live Histogram	X	X	X		
Flip	Horizontal	X	X	X	
	Vertical	X	X	X	
Rotate	X				

FUNCTION		OPTIKA PRO VIEW	OPTIKA LITE VIEW	OPTIKA VISION LITE
PROCESSING	Several function of image processing (filters)	X		
	Multiple image combining	X		
	EDF (Extended Depth of Focus)	X		
	Colour Combine (Multi-Fluorescence Imaging)	X		
	Shift Correction	X		
	HDR (High Dynamic Range)	X		
	Layer Management	X		X
	Text Overlay	X		
	Ruler Overlay	X		
	Measurement Overlay	X		
	Grids	X		X

4083.Wifi, 4083.4 and 4083.EC2 work with Vision Lite only. Cameras with HDMI connection only, do not require any software.

# 4 OPTIKA Vision Lite - Extremely Intuitive Software

**Optika Vision Lite** has been designed and developed to be incredibly intuitive, simple and easy to use for customers needing a convenient solution to be combined with OPTIKAM cameras.

- » Friendly interface, multilanguage
- » Capture still images & stream live videos
- » Perform linear measurements
- » Export comprehensive reports

## Friendly interface, multilanguage

Engineered for easy user interaction and optimized image acquisition, the main purpose of OPTIKA Vision Lite is ensure clear communication.

- An efficient means to efficiently completing your jobs
- Pleasant, easy-to-navigate menus
- Eight languages pre-installed, others upgradable

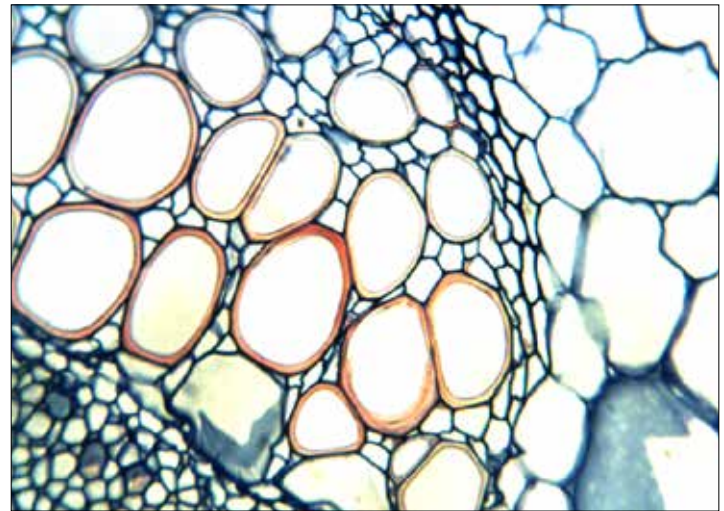

## Capture still images & stream live videos

Use the live preview to accurately focus your image and change parameters to obtain the perfect final result you are looking for. Images can be saved in different formats and even as test reports, including personal comments.

Additional features:

- Image stack acquisition
- Grid addition for rapid considerations
- Image flipping option available

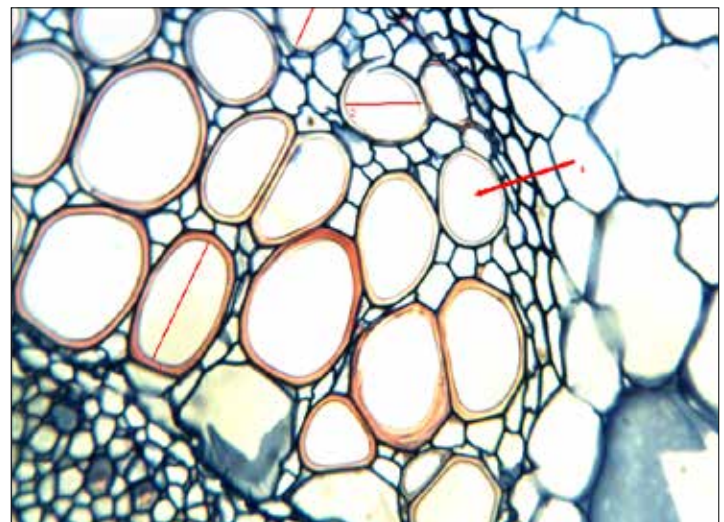

## Perform linear measurements

Perform linear measurements in an extremely way just by drawing a line after creating your preferred calibration based on the magnification.

- Accurate measurements through simple calibration
- Comprehensive data export (notes & measures included)
- Indicate particular objects in the image to add persona comments

## Export comprehensive reports

Detailed test reports can be generated, printed and saved. Reports can be also customized with company logos.

**Angular Collenchyma** **OPTIKA**  
MICROSCOPY

1. Length: 18,00774 micron  
2. Length: 10,58396 micron  
3. Length: 10,20079 micron  
4. Indication



**OPTIKA LITEView** is a basic image acquisition software. The user who simply wants acquire a still image or a video, with no need to perform measurements, has, with this powerful and intuitive software, the perfect solution.

- ) Simple management of «live» image
- ) Acquisition of still images or video
- ) Basic imaging functions
- ) Background correction



## Simple management of «live» image

Image preview is freely customizable by the user. A simple White Balance function with a mobile spot allows to perform the balance even on very small areas, once the specimen has been framed and focused.

Basic functions:

- Automatic or manual acquisition
- Possibility to have «live» and «capture» at different resolutions
- White Balance with mobile spot
- Background correction for the acquisition of perfectly illuminated images.

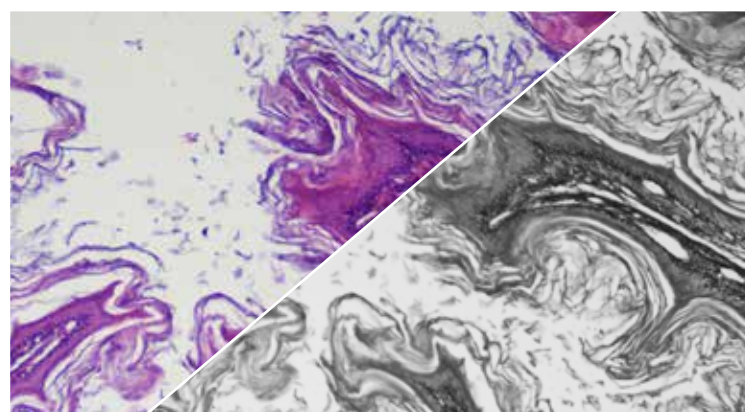
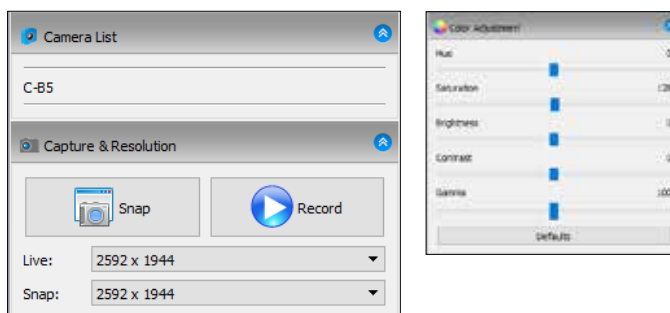

Color / Grey scales

## Capturing still images or video

Just select the option and the software performs: acquiring still images or videos is simply and intuitive.

## Basic imaging functions

Image parameters can be modified according user's needs. Color, Contrast and Gamma can be changed in real time.

More, it is possible to use a color camera in «SGrey Scales» modo in order to increase the camera sensitivity.

## Background Correction

Any inhomogeneity of illumination of the microscope can be corrected by using the background correction function.

This allows to obtain a faithful reproduction of the image without annoying inhomogeneity due to a not perfect illumination.



No Background correction



With Background correction

# 4 OPTIKA PROView - Professional Image Analysis

**OPTIKA PROView** is a professional image analysis software. The user who needs to acquire an image or video and to perform a series of processings or measurements, can easily achieve incredible results thanks to this software. PROView incorporates all the functions of the LITEView package, but in addition allows:

- White Balance and Black Balance
- Simultaneous management of several cameras
- Graphical User Interface fully customizable
- Imaging of Multichannel Fluorescence Images with «pixel shift» function
- Multilanguage Software

### Beginners? Experts?

An «On-line» manual will help any user (no matter on how expert he can be) to get the best from the software

### Images always perfect

The management of the acquisition parameters allows to get always the best from your camera. White balance, black balance, background correction, «live» management of Colors, Contrast, Gamma, Gain and Exposure Time ensure to obtain a faithful image. A numerical focus indicator will ensure an optimal focusing, also on specimens with different focal planes.

### White Balance and Black Balance

It is possible to obtain the balance either on the whole frame or on a small ROI (Region Of Interest) of the image simply resizing and moving the spot in one part of the specimen

### Multichannel Fluorescence Image processing

Acquire fluorescence images with a specific filtercube, use a false color for the used fluorochrome, get a single multichannel image is simply and intuitive.

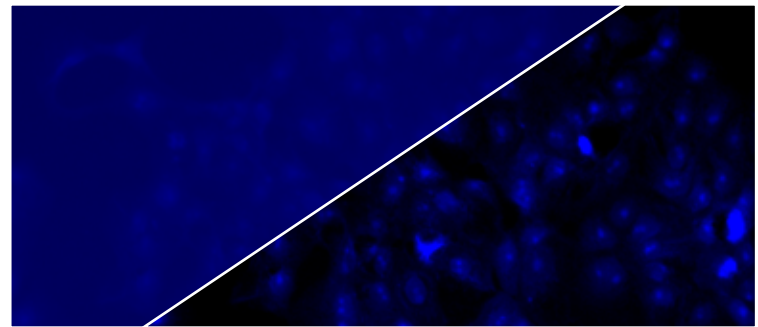
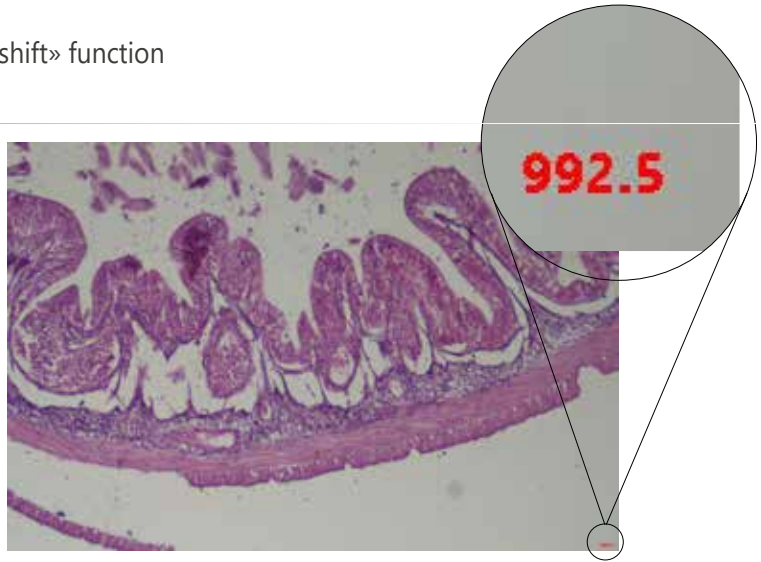

No black correction / Black correction

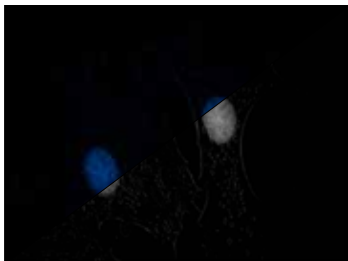

DAPI (UV)

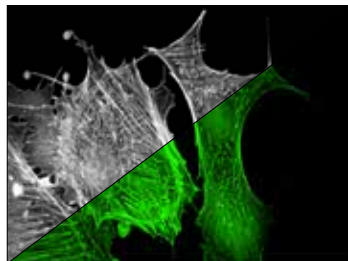

FITC (B)

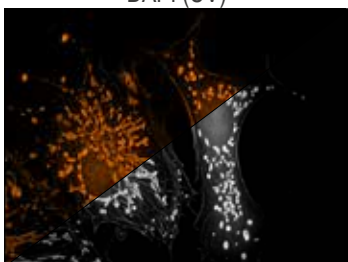

TEXAS RED (G)

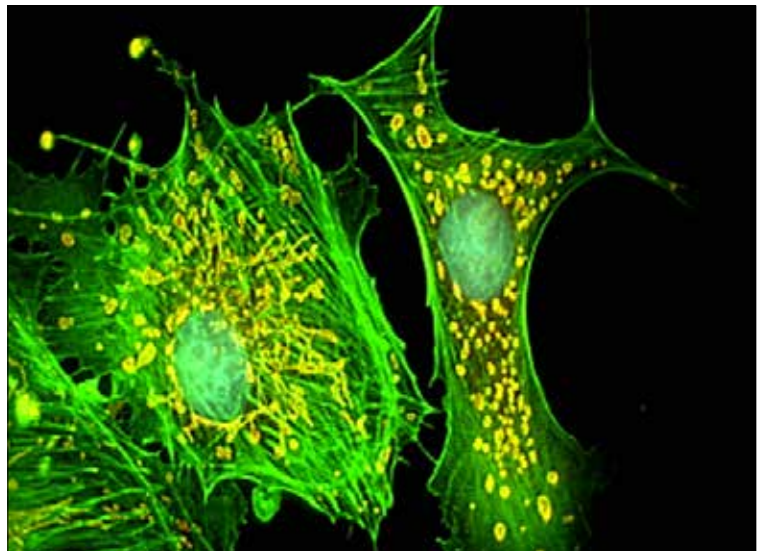

Combined multichannel image

## «Pixel Shift» function

Fluorescence filter cubes, sometimes, are not perfectly aligned.

During acquisition of multichannel fluorescence images, this can cause a non perfect overlapping of the different signals, making the colocalization calculation almost impossible.

«Pixel Shift» function allows to correct these small misalignments:

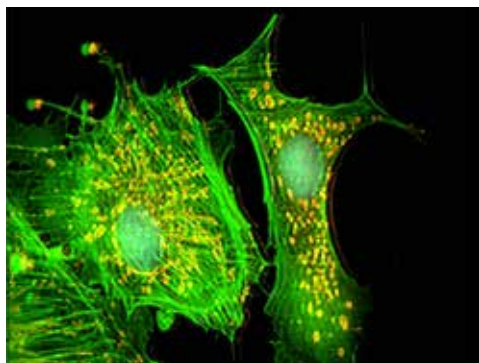

Original image

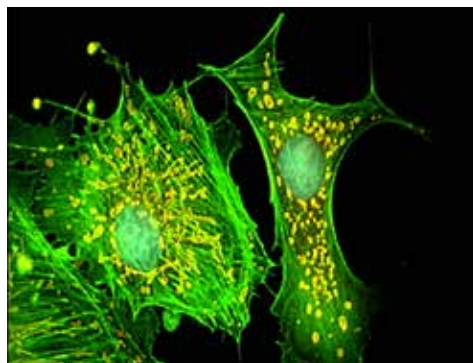

Corrected image

## HDR (High Dynamic Range) acquisition

Acquisition of different images with different exposure times allows this function to create a final image where bright and dark zones of the specimen are perfectly displayed.

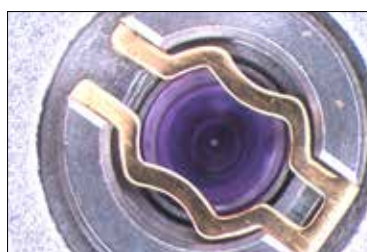

Standard Dynamic Range

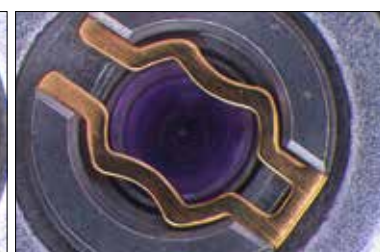

High Dynamic Range

## Extended Depth of Focus (EDF)

Acquire images with different focal planes, specially on specimens observed under a stereomicroscope, and to obtain a focused final image with a theoretical infinite focus. **EDF** function (also known as «Z-stack») allows a very refined image processing.



Single Focal Plane Images



EDF Image

## Stitching & Tiling

Get an image with high resolution but, at the same time, have a wide view of the specimen under observation.

Impossible? No. The multiple image alignment function allows to get a single image starting from adjacent images of the specimen.

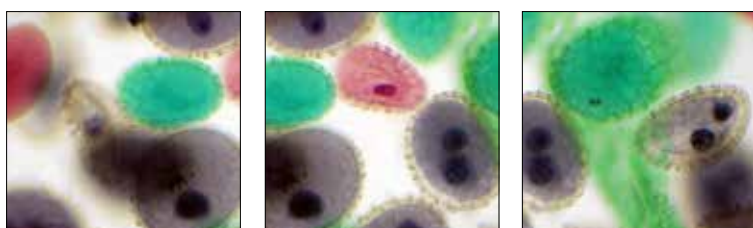

Separate Images



Stitched image

## Measurements

User can perform measurements on the «live» image (no need to capture an image) and on captured images.

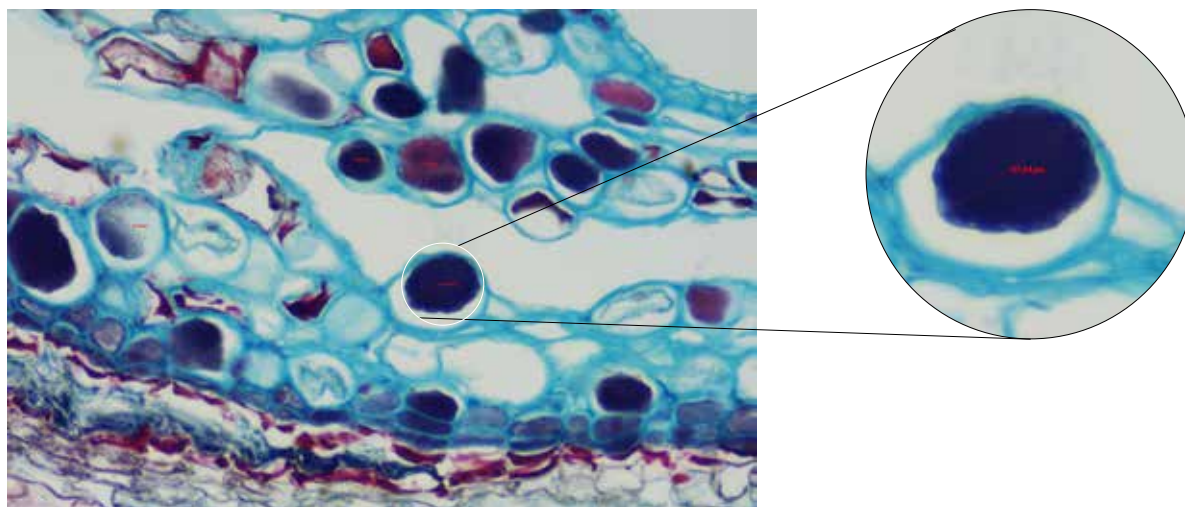

## From Beginners To Experts

Measurements available:

- linear measurements
- angles
- circles
- annuli
- polygons
- touch count

## Report Generator

At the end of the analysis it is possible to export images and measurement results either on a Excel sheet and on a Report Generator in MS Word format.

The template is freely configurable and can be modified according to laboratory standards.

**OPTIKA®**  
I T A L Y

Testing Material Lab

Test Report

Specimen: Gear  
Material: Cast iron  
Test: Macro + Micro  
Production Batch: GY-04-2018  
Date: 2018-04-10 08:40:09

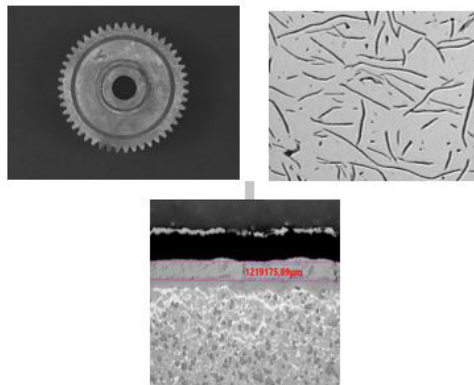

Measurements:

Index	Length(µm)	Angle(°)	Distance(µm)
1	16154719,49, 16129320,00	179,64	1219175,89

Comments:

Operator: \_\_\_\_\_

Chief of Laboratory: \_\_\_\_\_

v 1.4.0 - OPTIKA reserves the right to make corrections, modifications, enhancements, improvements and other changes to its products at any time without notice.

## Headquarters and Manufacturing Facilities

**OPTIKA® S.r.l.** Via Rigla, 30 - 24010 Ponteranica (BG) - ITALY - Tel: +39 035.571.392 - info@optikamicroscopes.com

## Optika Sales branches

**OPTIKA® Spain** spain@optikamicroscopes.com  
**OPTIKA® China** china@optikamicroscopes.com  
**OPTIKA® India** india@optikamicroscopes.com

**OPTIKA® USA** usa@optikamicroscopes.com  
**OPTIKA® Central America** america@optikamicroscopes.com

# OPTISCAN



**OPTISCAN10**  
Digital scanner

# 4 OPTISCAN10 - 4083.SC10

## CONVERT YOUR GLASS SLIDES INTO DIGITAL DATA !

Rapid and high resolution scanner to convert your slides into digital slides. The digital slide can be easily manipulated to see any location at any magnifications. Digitizing slides opens up a variety of new possibilities, like:

- Creating a database to be incorporated into a laboratory information system
- Networking slide libraries to be consulted from distant facilities and research institutes
- Sharing expertise for evaluation processes and discussing
- Information storing (digital data does not deteriorate, are secure from damages and losses)

Main application fields are quality control & research, education, veterinary, histology / pathology, entomology / insectology, etc.

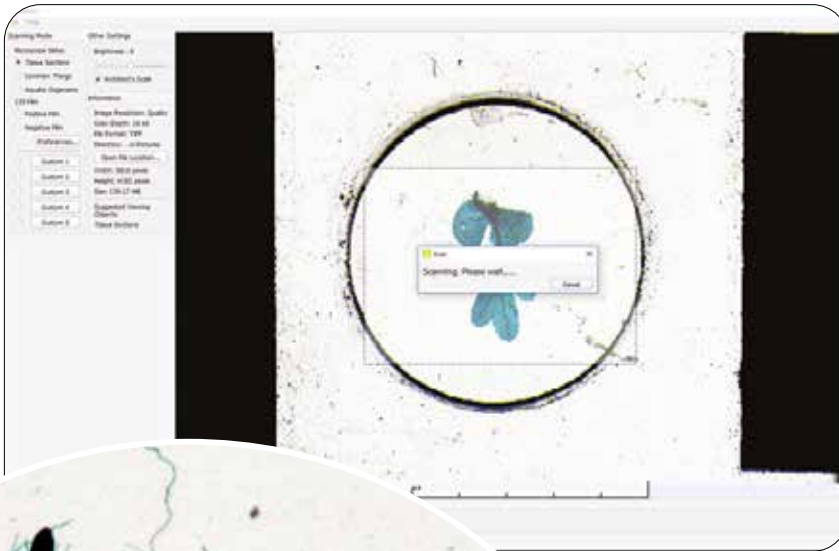

### Main Features:

- High Resolution (up to 10.000 dpi)
- True & Neutral Color Fidelity
- White Balance & Distortion-free Images
- Dedicated Illumination (LED Transmitted Light)
- Efficient Scanning Area, Wide Field of View
- Impressive Scanning Speed (from 40 sec. to few minutes)
- High Sensitivity CCD Sensor
- Largest Field Of View, Better Than Any Camera



### Ideal for:

- building up a comprehensive database of images for routine operations
- sharing expertise for evaluation processes
- archiving confidential patient information



# OPTISCAN10 - Technical Specifications

**OPTISCAN10** is an extremely convenient scanner for professionals, labs & teaching purposes, offering unmatched price/performance ratio and coming along with a comprehensive but user-friendly software.

A ultra efficient, compact scanning device carrying high resolution features for spot detection with easy operation figure.

It is equipped with a dedicated LED transmitted light system and high resolution CCD sensor, ensuring high sensitivity with low background noise.

Signal output	USB 2.0
Illumination	LED
Resolution	5'000 dpi (Normal), 10'000 dpi (Quality)
Allowed slide	Standard 24 x 75 mm
Scan view size	Any size, Max 24 x 36mm
Prescan function time	25 seconds
Scanning time (Normal)	1min 30sec (24 x 36mm); 40 sec (standard 15x15mm cover slide)
Scanning time (Quality)	2min 10sec (24 x 36mm); 1min (standard 15x15mm cover slide)
Always included	1.5 m USB cable, power supply, CD rom
System requirements	Windows XP service pack 2, Vista / win7 / win8 / win10 / 32-64 bit / USB 2.0
Supplied software	Multilanguage software for image scan
Capture features	Prescan, slide scan 24x36mm, crop scan, brightness, contrast, saturation, image flip



v 1.4.0 - OPTIKA reserves the right to make corrections, modifications, enhancements, improvements and other changes to its products at any time without notice.

---

## Headquarters and Manufacturing Facilities

---

**OPTIKA® S.r.l.** Via Rigla, 30 - 24010 Ponteranica (BG) - ITALY - Tel.: +39 035.571.392 - [info@optikamicroscopes.com](mailto:info@optikamicroscopes.com)

## Optika Sales branches

---

**OPTIKA® Spain** [spain@optikamicroscopes.com](mailto:spain@optikamicroscopes.com)

**OPTIKA® China** [china@optikamicroscopes.com](mailto:china@optikamicroscopes.com)

**OPTIKA® India** [india@optikamicroscopes.com](mailto:india@optikamicroscopes.com)

**OPTIKA® USA**

**OPTIKA® Central America**

[usa@optikamicroscopes.com](mailto:usa@optikamicroscopes.com)

[america@optikamicroscopes.com](mailto:america@optikamicroscopes.com)



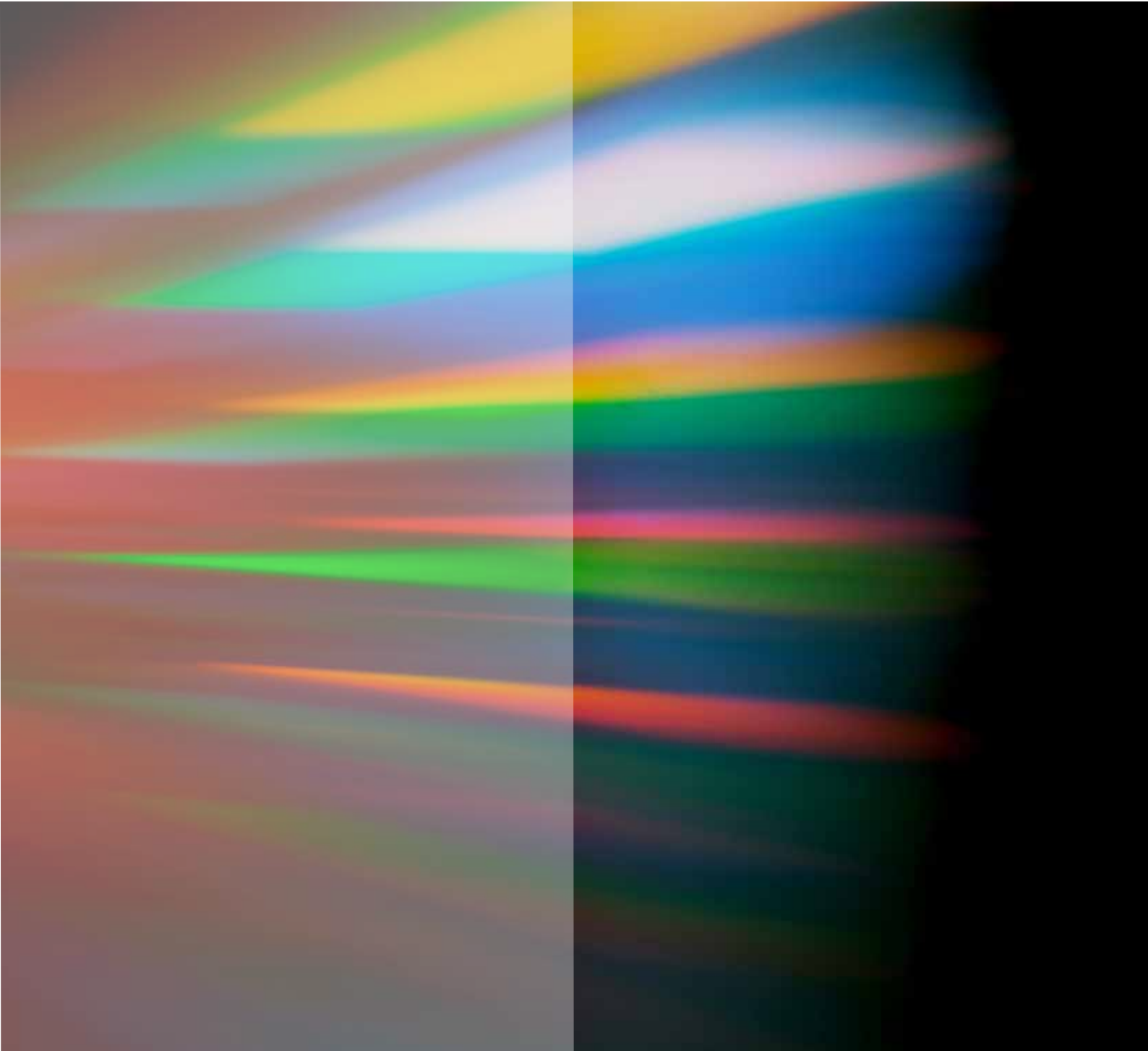

**POLARIMETRY AND REFRACTOMETRY**

# Extremely Reliable Polarimeter for Practical Experience

## THE STATE-OF-THE-ART POLARIMETER

### Combining wide measuring range with simplicity

- » Entirely Made in Italy
- » Outstanding quality/price ratio
- » New design for a compact and space-saving solution

## MONOCHROMATIC LED LIGHT SOURCE

### Instead of traditional sodium bulb

- » Unparalleled illumination
- » 30x longer lifespan than conventional polarimeters
- » Plug & play, no heating time required



# Polarimeter - POL-X

The POL-X polarimeter from Optika precisely determines the optical rotation of substances, quickly and easily. POL-X measures the optical rotation over the entire measuring range at the same high accuracy. It's suitable for many applications, from routine measurements to demanding experiments for innovative projects. With this new polarimeter, OPTIKA meets the requirements of the pharmaceutical, cosmetics, chemical and medical industries and creates an ideal tool for R&D applications.



Polarimetry is used in the Educational field (for physics & chemistry dept.) and for Quality & Process Control in Labs. It provides the concentration and purity of a substance before it is added to an expensive batch.



Optical rotation is an indispensable quality and identity assay for a wide range of critical industries. Food, drug, and flavors industries use polarimetry as a quality attribute both for raw ingredients and also finished products.

# Polarimeter - POL-X

## Technical Specifications

**Measuring range of optical rotation:**  $\pm 180^\circ$

**Resolution:**  $1^\circ$

**Accuracy:**  $0.05^\circ$

**Magnification factor of the glass:** 4x

**Light source:** Monochromatic LED, 1.2 W,  $\lambda_d = 590$  nm (equivalent to sodium lamp)

**Length of test tubes:** 100 mm and 200 mm

**Weight:** 1.7 Kg

**Overall dimensions:** 450x180x320 mm

**Accessories:**

POL-1.2 - 100 mm polarimeter tube

POL-1.3 - 200 mm polarimeter tube



## Target Industries

### Food

Concentration and purity of compounds (carbohydrates, lactose, raffinose, various starches, fructose, levulose, sucrose, natural monosaccharides, glucose, maltose, xylose) in sugar based foods, cereals and syrups.



### Chemical

Identification and characterization of polymers (bio-, natural or synthetic), foods, cereals and syrups.



### Pharmaceutical

Determination of product purity by measuring specific and optical rotation of amino acids, antibiotics, dextrose, steroids, amino sugars, cocaine, diuretics, tranquilizers, analgesics, codeine, serums, vitamins, etc.



### Fragrance, Flavor & Essential Oils

Inspection of incoming raw materials, such as camphors, gums, orange oil, citric acid, lavender oil, spearmint oil, glyceric acid, lemon oil, etc.



# Refractometers - HR & HRD Series



OPTIKA offers a wide range of hand refractometers to ensure incredibly rapid and convenient measurement of concentration in liquid and semi-solid samples, combining **accurate performance with excellent repeatability.**

The refractive index of a substance is related to its specific density; a refractometer is used to measure the purity or the concentration of a sample when mixed.

Refractometers are suitable for a wide range of applications, which includes the control of blend ratios in light industrial applications (such as glycols, battery acid, heat exchange fluids, coolants, quenchants and hydraulic oils) and represents the ideal solution for users working in the food industry (fruit, beverages, confectionery, jam, honey and other sugar based products).

- » **Value for money solution**
- » **Easy operation**
- » **Built-in LED illumination**
- » **Brix or scale specific (including ATC)**
- » **Sturdy construction with rubber handgrip**



Fruit



Fruit juice



Veterinary industry



Battery fluids



Honey



Wine



Clinical industry



Salinity



Confectionery/Jam



Grape must



Coolants/Antifreeze



Food industry

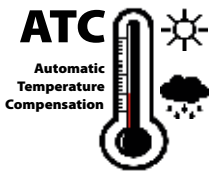

**ATC** - Automatic Temperature Compensation  
No need to worry about temperature change during your measurement.



**LED**

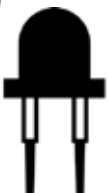

**LED**  
Scale reading has never been so easy, also in case of low light conditions.



# HR Series - Hand Refractometers

## HR-110N - Hand Refractometer, 0-20% Brix, ATC, Built-in LED Illuminator

Measure Range	Min. Div	Accuracy
0-20% Brix	0.1 Brix	±0.10 Brix

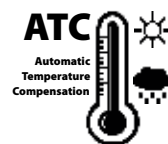
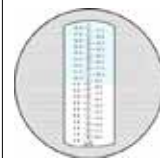

## HR-130N - Hand Refractometer, 0-32% Brix, ATC, Built-in LED Illuminator

Measure Range	Min. Div	Accuracy
0-32% Brix	0.2 Brix	±0.2 Brix

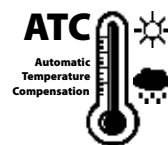
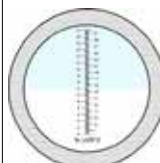

## HR-140N - Hand Refractometer, 0-32% Brix, ATC, Triple Scale, Built-in LED Illuminator

Measure Range	Min. Div	Accuracy
0-32% Brix	0.2 Brix	±0.2 Brix
0-140 °Oe	1 °Oe	±1 °Oe
0-27 KMW(Babo)	0.2 KMW(Babo)	±0.2KMW(Babo)

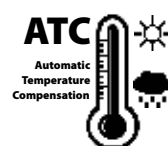
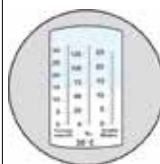

## HR-150N - Hand Refractometer, 0-80% Brix, Double Scale, Built-in LED Illuminator

Measure Range	Min. Div	Accuracy
0-80% Brix	0.5 Brix	±0.5 Brix

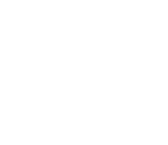
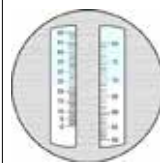

## HR-160N - Hand Refractometer for Urine and Protein, ATC, Built-in LED Illuminator

Measure Range	Min. Div	Accuracy
1.000-1.050 sg	0.002 sg	± 0.002 sg
1.3300 RI - 1.3600 RI	0.0005 RI	± 0.0005 RI
0-12 g/dl	0.2 g/dl	± 0.2 g/dl

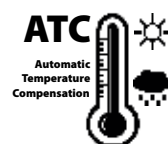
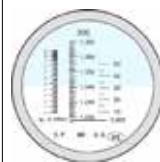

## HR-170N - Hand Refractometer for Battery and Antifreeze, ATC, Built-in LED Illuminator

Measure Range	Min. Div	Accuracy
E: -60° F - 32° F	10° F	± 10°F
P: -50° F - 32° F	10° F	± 10°F
B: 1.15-1.30 sg	0.01 sg	± 0.1sg

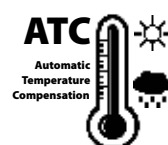
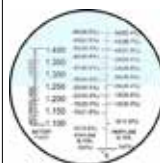

## HR-180N - Hand Refractometer for Wine and Grape, ATC, Built-in LED Illuminator

Measure Range	Min. Div	Accuracy
0-25% Vol	0.1% Vol	±0.1 Vol
0-40% Brix	0.2% Brix	±0.2 Brix

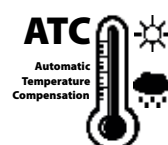
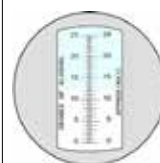

## HR-190N - Hand Refractometer, 0-28% Salinity, ATC, Built-in LED Illuminator

Measure Range	Min. Div	Accuracy
0-28% Salinity	0.2%	±0.2%

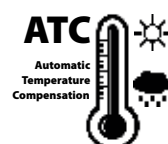
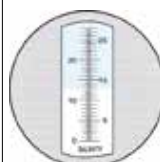

# HRD Series - Digital Refractometers

## HRD-300N - Digital Refractometer, Brix and Refractive Index

Measure Range	Min. Div	Accuracy
Brix 0-50%	0.10%	±0.2 %
Refractive index: 1.3330-1.4200nD	0.0001 nd	± 0.0003 nD

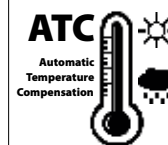

## HRD-400N - Digital Refractometer, Brix, Salinity and Refractive Index

Measure Range	Min. Div	Accuracy
Brix 0-50%	± 0.1 %	± 0.2 %
Salinity 0.0-28.0%	Salinity ± 0.1%	± 0.2 %
Refractive index: 1.3330-1.4200 nD	± 0.0001 nD	± 0.0003 nD

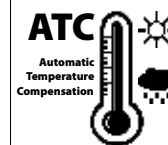

## HRD-500N - Digital Refractometer for Urine, Serum Protein and Refractive Index

Measure Range	Min. Div	Accuracy
Urine SPG 1.000-1050	0.001	±0.002
SERUM P. 0.12 g/dl	0.1	±0.2
Refractive index: 1.3330-1.3900 nD	±0.0001 nD	±0.0003 nD

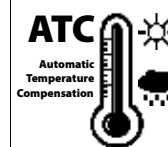

# Refractometers - 2WAJ ABBE Bench Refractometer



Abbe bench-top refractometer measures refractive index ND and average color dispersion NF-NC of transparent and semi-transparent liquid or solid samples. It is a must-have equipment in factories, teaching institutes and science research centers related to oil, grease, pharmacy, painting, food, sugar-refining and geological industries, among the others. It is unique thanks to its ability in measuring also solid samples, such as film, glass, and other transparent materials.

**Main prism:** horizontal  
**Secondary prism:** fitted on a hinge  
**Refraction index scale:** Nd 1.300 – 1.700  
**Precision:** Nd ± 0.0003  
**Division:** Nd 0.0005  
**Sugars scale:** 0-95% from Nd 1.300 – 1.530  
**Precision:** 0-50% = 0.2%; 51-95% = 0.1%  
**Division:** 0.25%  
**Thermometer scale:** 0°C - 70°C, div. 1°C  
**Weight:** 4 Kg  
**Size:** 140x100x235 mm

v 1.4.0 - OPTIKA reserves the right to make corrections, modifications, enhancements, improvements and other changes to its products at any time without notice.

---

## Headquarters and Manufacturing Facilities

---

**OPTIKA® S.r.l.** Via Rigla, 30 - 24010 Ponteranica (BG) - ITALY - Tel.: +39 035.571.392 - [info@optikamicroscopes.com](mailto:info@optikamicroscopes.com)

### Optika Sales branches

---

**OPTIKA® Spain** [spain@optikamicroscopes.com](mailto:spain@optikamicroscopes.com)  
**OPTIKA® China** [china@optikamicroscopes.com](mailto:china@optikamicroscopes.com)  
**OPTIKA® India** [india@optikamicroscopes.com](mailto:india@optikamicroscopes.com)

**OPTIKA® USA** [usa@optikamicroscopes.com](mailto:usa@optikamicroscopes.com)  
**OPTIKA® Central America** [camerica@optikamicroscopes.com](mailto:camerica@optikamicroscopes.com)





---

**OPTIKA Microscopes** is committed to pursuing the full realization and continuous evolution of the Quality Management System in order to consolidate and improve the Company image, also through the commitment and professionalism of all Company staff.

---

v 1.2.1 - OPTIKA reserves the right to make corrections, modifications, enhancements, improvements and other changes to its products at any time without notice.

---

## Headquarters and Manufacturing Facilities

---

**OPTIKA® S.r.l.** Via Rigla, 30 - 24010 Ponteranica (BG) - ITALIA - Tel.: +39 035.571.392 - Fax: +39 035.571.435 - [info@optikamicroscopes.com](mailto:info@optikamicroscopes.com)

## Optika Sales branches

---

**OPTIKA® Spain** [spain@optikamicroscopes.com](mailto:spain@optikamicroscopes.com)  
**OPTIKA® China** [china@optikamicroscopes.com](mailto:china@optikamicroscopes.com)  
**OPTIKA® India** [india@optikamicroscopes.com](mailto:india@optikamicroscopes.com)

**OPTIKA® USA** [usa@optikamicroscopes.com](mailto:usa@optikamicroscopes.com)  
**OPTIKA® Central America** [america@optikamicroscopes.com](mailto:america@optikamicroscopes.com)